

APPENDIX 14.1 TRAFFIC & TRANSPORT ASSESSMENT



Waterman Moylan
Engineering Consultants

Traffic and Transport Assessment

Dunshaughlin West / Phase 2 SHD, County Meath.

September 2020

Waterman Moylan Consulting Engineers Limited

Block S, East Point Business Park, Alfie Byrne Road, Dublin D03 H3F4
www.waterman-moylan.ie



Waterman Moylan
Engineering Consultants

Client Name: Castlethorn Construction Ltd.
Document Reference: 12-081Ar.002 Traffic and Transport Assessment
Project Number: 12-081A

Quality Assurance – Approval Status

This document has been prepared and checked in accordance with
Waterman Group's IMS (BS EN ISO 9001: 2015 and BS EN ISO 14001: 2015)

Issue	Date	Prepared by	Checked by	Approved by
DRAFT	Sep '20	F Silva	J Ulicna	
Final	Sep '20	F Silva	I. Swartz	

Comments

Disclaimer

This report has been prepared by Waterman Moylan, with all reasonable skill, care and diligence within the terms of the Contract with the Client, incorporation of our General Terms and Condition of Business and taking account of the resources devoted to us by agreement with the Client.

We disclaim any responsibility to the Client and others in respect of any matters outside the scope of the above.

This report is confidential to the Client and we accept no responsibility of whatsoever nature to third parties to whom this report, or any part thereof, is made known. Any such party relies on the report at its own risk.

Contents

- 1. Introduction 1**
 - 1.1 Introduction and Background 1
 - 1.2 Scope..... 1
 - 1.3 Standards..... 1
 - 1.4 Threshold for Transport Assessment 2
 - 1.5 Contents of the Transport Assessment 2
 - 1.6 Location of Development 2
 - 1.7 Methodology 3
 - 1.8 Program 4
 - 1.9 Assessment Years 4
 - 1.10 Assessment Junctions 4
 - 1.11 Assessment Site Layouts 5

- 2. Policy Framework..... 7**
 - 2.1 Meath County Development Plan (2013 – 2019)..... 7
 - 2.1.1 Development Plan Core Principles..... 7
 - 2.1.2 Settlement Strategy 7
 - 2.1.3 Transportation 7
 - 2.1.4 Dunshaughlin Zoning Map 8

- 3. Receiving Environment..... 9**
 - 3.1 Existing Roads and Junctions..... 9
 - 3.1.1 Roads 9
 - 3.1.2 Junctions..... 9
 - 3.2 Existing Public Transport..... 10
 - 3.2.1 Bus 10
 - 3.2.2 Rail 12
 - 3.3 Existing Cycle Facilities 13
 - 3.4 Existing Pedestrian Facilities 14
 - 3.5 Traffic Survey 14

- 4. Transportation Improvements 17**
 - 4.1 Roads and Junctions 17
 - 4.1.1 Drumree Road / Phase 1 Site Access Roads (Signalised Junction)..... 17
 - 4.1.2 R125 Dunshaughlin Link Road / Phase 1 Site Access Road (Roundabout) 17
 - 4.2 Public Transport 18
 - 4.2.1 DART Expansion Programme and Heavy Rail Line Extension to Navan..... 18
 - 4.3 Cycle Facilities 19

4.4	Pedestrian Facilities	20
5.	Proposed Development.....	21
5.1	Development Description.....	21
5.2	Site Access Points.....	22
5.2.1	North Site.....	22
5.2.2	South Site	22
5.3	Internal Layout	22
5.4	Pedestrian and Cyclist Infrastructure	23
5.4.1	North Site.....	23
5.4.2	South Site	23
6.	Trip Generation.....	24
6.1	TRICS – Trip Rates	24
6.2	Proposed Development – Phase 2	24
6.2.1	North Site.....	24
6.2.2	South Site	25
6.3	Under Construction Development – Phase 1 (DA/120987).....	25
6.4	Potential Neighbourhood Centre.....	26
7.	Trip Distribution	29
7.1	Proposed Development – Phase 2	29
7.1.1	North Site.....	29
7.1.2	South Site	29
7.2	Under Construction Development – Phase 1 (DA/120987).....	30
7.3	Potential Neighbourhood Centre.....	30
8.	Traffic Growth and Permitted Developments in Dunshaughlin.....	31
8.1	Traffic Growth.....	31
8.2	Permitted Developments in Dunshaughlin	31
9.	Junction Assessment	33
9.1	Assessed Junctions.....	33
9.2	Methodology	33
9.2.1	Cumulative Impact.....	33
9.2.2	Modelling Background	34
9.3	Assessment Scenarios	34
9.4	Junctions Assessment Results	35
9.4.1	Junction 1 - R147 / R125 / Drumree Road	35
9.4.2	Junction 2 - R147 / Lagore Road	37
9.4.3	Junction 3 - R125 / L2208 / Drumree Road.....	39

9.4.4	Junction 4 – Drumree Road / Access Roads to Phase 1	41
9.4.5	Junction 5 - R125 / Access Road to Phase 1	43
9.4.6	Junction 6 – L2208 / Access Road to Phase 2 North Site.....	45
9.4.7	Junction 7 - R125 / Access Road to Phase 2 South Site	45
10.	Construction Traffic	47
11.	Servicing.....	48
11.1	Waste Collection	48
12.	Car Parking.....	49
12.1	Meath County Development Plan 2013 – 2019 – Standards and Requirements	49
12.1.1	Phase 2 - North Site	49
12.1.2	Phase 2 - South Site.....	49
12.2	Design Standards for New Apartments – March 2018.....	50
12.3	Car Parking Proposed	51
13.	Bicycle Parking.....	52
13.1	Meath County Development Plan 2013 – 2019 – Standards	52
13.1.1	Phase 2 - North Site	52
13.1.2	Phase 2 - South Site.....	52
13.2	Design Standard for New Apartments, March 2018.....	53
13.3	Bicycle Parking Proposed.....	54
14.	Road Safety	55
14.1	Accidents	55
15.	Non-Technical Summary.....	56

Figures

Figure 1	Location of Proposed (Phase 2) and Under-Construction (Phase 1) Developments.....	3
Figure 2	Location Map for Assessed Junctions.	5
Figure 3	Location of Proposed Phase 2 Development – Dunshaughlin Zoning Map.	8
Figure 4	Existing Road Network and Main Junctions.....	10
Figure 5	Location of Closest Bus Stops.	11
Figure 6	Driving Route from Proposed Development Sites to M3 Parkway Station.	12
Figure 7	Existing Cycle Facilities Map – Sheet E15, Extracted from GDA Cycle Network Plan. ...	13
Figure 8	Location of Surveyed Junctions.	15
Figure 9	Surveyed AM and PM Peak Hour Flows – February 2020.	16
Figure 10	Location Map for Phase 1 Approved Junctions.....	18
Figure 11	Proposed Cycle Network Upgrades.....	19
Figure 12	Location of Proposed (Phase 2) and Under-construction (Phase 1) Developments.....	21

Figure 13 Location of Neighbourhood Centre – Extracted from Dunshaughlin Zoning Map.....	27
Figure 14 RSA Traffic Collision Data – 2005 to 2016.....	55

Tables

Table 1 Bus Eireann Service Routes.....	11
Table 2 TRICS Trip Rates – AM and PM Peak Hours.....	24
Table 3 AM and PM Peak Hours - Car Trip Generation – North Site of Proposed Phase 2.....	24
Table 4 AM and PM Peak Hours - Car Trip Generation – South Site of Proposed Phase 2.....	25
Table 5 TRICS Trip Rates – AM and PM Peak Hours – extracted from Approved Phase 1 TIA....	25
Table 6 AM and PM Peak Hours – Car Trip Generation – Under-construction Phase 1.....	26
Table 7 TRICS Trip Rates – AM and PM Peak Hours – extracted from Approved Phase 1 TIA....	27
Table 8 AM and PM Peak Hours – Car Trip Generation – Potential Neighbourhood Centre.....	28
Table 9 Existing and Expected Two-way Flows.....	33
Table 10 Junction 1 – 2020 BASE YEAR – TRANSYT Analysis Results.....	35
Table 11 Junction 1 – 2024 DO NOTHING and DO SOMETHING – TRANSYT Analysis Results.	36
Table 12 Junction 1 – 2039 DO NOTHING and DO SOMETHING – TRANSYT Analysis Results.	37
Table 13 Junction 2 – 2020 BASE YEAR – PICADY Analysis Results.....	38
Table 14 Junction 2 – 2024 DO NOTHING and DO SOMETHING – PICADY Analysis Results....	38
Table 15 Junction 2 – 2024 and 2039 DO SOMETHING – PICADY Analysis Results.....	39
Table 16 Junction 3 – 2020 BASE YEAR – ARCADY Analysis Results.....	40
Table 17 Junction 3 – 2024 DO NOTHING and DO SOMETHING – ARCADY Analysis Results. .	40
Table 18 Junction 3 – 2039 DO NOTHING and DO SOMETHING – ARCADY Analysis Results. .	41
Table 19 Junction 4 – 2024 DO NOTHING and DO SOMETHING – TRANSYT Analysis Results.	42
Table 20 Junction 4 – 2039 DO NOTHING and DO SOMETHING – TRANSYT Analysis Results.	43
Table 21 Junction 5 – 2024 DO NOTHING and DO SOMETHING – ARCADY Analysis Results. .	44
Table 22 Junction 5 – 2039 DO NOTHING and DO SOMETHING – ARCADY Analysis Results. .	44
Table 23 Junction 6 – 2024 and 2039 DO SOMETHING – PICADY Analysis Results.....	45
Table 24 Junction 7 – 2024 and 2039 DO SOMETHING – ARCADY Analysis Results.....	46
Table 25 Phase 2 North Site – Car Parking Spaces Required – MCDP 2013 – 2019.....	49
Table 26 Phase 2 South Site – Car Parking Spaces Required – MCDP 2013 – 2019.....	50
Table 27 Phase 2 North Site – Bicycle Parking Spaces Required – MCDP 2013 – 2019.....	52
Table 28 Phase 2 South Site – Bicycle Parking Spaces Required – MCDP 2013 – 2019.....	53
Table 29 Phase 2 North and South Sites – Bicycle Parking Spaces Required – DSNM 2018.....	53
Table 30 Summary of Minor Collisions along R125 and Drumree Road.....	55

Appendices

- A. Traffic Survey
- B. TRICS Output Report
- C. Trip Distribution/Assignment and Traffic Forecast
- D. Junction Assessment – Layout Option 2
- E. ARCADY, PICADY and TRANSYT Output Reports

1. Introduction

1.1 Introduction and Background

This Traffic and Transport Assessment (TTA) has been prepared by Waterman Moylan as part of a pre-planning submission to An Bord Pleanála for a proposed Strategic Housing Development (SHD) of 415 No. residential units with supporting creche facility in Dunshaughlin, County Meath.

The proposed development is the second phase of an overall development located adjacent to R125 Dunshaughlin Link Road approximately 1.0km west of Dunshaughlin Town Centre.

The Phase 1 residential development was approved by Meath County Council in April 2013 under Reg. Ref DA/120987, ABP Ref. PL17.241988 and is currently under construction nearing completion. The permission provided for the construction of 142 No. residential units to be delivered in two distinct areas - one the north and one to the south of Drumree Road. See Figure 1.

As part of the under construction Phase 1 three access to the sites were also approved, two located on Drumree Road, each forming the minor arms of the approved four-armed signal controlled junction and one on R125 forming the eastern arm of the approved four-armed roundabout. See Figure 1.

The proposed Phase 2 development will comprise a total of 415 No. residential units and a Creche to accommodate a total of 80 children and 16 staff on site. Phase 2 development is also proposed to be delivered in two distinct areas, one to the north of L2208 and west of R125 (North Site) and the other to the south of the approved Phase 1 and east of R125 (South Site). See Figure 1.

The **North Site** will comprise a total of 149 No. residential units (95 No. houses, 20 No. duplexes and 34 No. apartments). Vehicular access to the North Site is proposed off L2208 via a new priority-controlled T-junction.

The **South Site** will comprise 266 No. residential units (159 No. houses, 35 No. duplexes and 72 No. apartments) and the Creche. Main vehicular accesses to the South Site will be provided off R125 Dunshaughlin Link Road, (a) via the roundabout approved under Phase 1 development (Reg. Ref. DA/120987) and (b) via the existing two-armed roundabout - at the southwestern edge of the site; which is proposed to be updated to a three-armed roundabout with the site access road forming the eastern arm. A third access to the South Site will be provided from Drumree Road via the under-construction Phase 1 development.

1.2 Scope

This TTA is a comprehensive review of all the potential transport impacts of the overall development, including a detailed assessment of the transportation systems provided and the cumulative impact of the proposed Phase 2, the under-construction Phase 1 (Reg. Ref. DA120987) and a potential Neighbourhood Centre on the surrounding transportation network.

1.3 Standards

This Traffic and Transport Assessment has been prepared in accordance with the requirements of the Traffic and Transport Assessment Guidelines published by National Roads Authority in May 2014.

1.4 Threshold for Transport Assessment

Section 2.1 of the Traffic and Transport Assessment Guidelines (May 2014) requires submission of a Transport Assessment where a proposed development meets one or more of the following criteria:

- 1- Traffic to and from the development exceeds 10% of the traffic flow on the adjoining road;
- 2- Traffic to and from the development exceeds 5% of the traffic flow on the adjoining road where congestion exists, or the location is sensitive;
- 3- Residential development in excess of 200 dwellings;
- 4- Retail and leisure development in excess of 1,000sqm;
- 5- Office, education and hospital development in excess of 2,500sqm;
- 6- Industrial development in excess of 5,000sqm;
- 7- Distribution and warehousing in excess of 10,000sqm.

In the case of the subject development, thresholds No. 1, 2 and 3 are exceeded.

1.5 Contents of the Transport Assessment

In compliance with Section 3.3 of the Traffic and Transport Assessment Guidelines (May 2014), the contents of this TTA include:

- Description of the existing and proposed traffic/transportation conditions including information on the current traffic, critical junctions, pedestrians, cycle and public transport facilities;
- Description of the proposed Phase 2 development;
- Description of under-construction Phase 1 development and potential Neighbourhood Centre;
- The traffic and transportation implications of the development including consideration of trip generation/attraction and trip distribution;
- The time periods applicable to the TTA;
- The impact of the development on the surrounding road network including analysis of junction's capacity;
- Description of car and cycle parking requirements and proposals;
- Review of the historical data related to road safety;
- Non-technical Summary.

1.6 Location of Development

The overall development site is located in Dunshaughlin, County Meath adjacent to R125 west of the GAA Sports Grounds.

The **North Site** is bounded to the north and west by agricultural lands, to the south by the L2208 and to the east by the R125 Dunshaughlin Link Road. The North Site also surrounds an existing property in the south eastern corner of the site.

The **South Site** is bounded to the north by the under-construction development of Phase 1 (Reg. Ref. DA/120987), to the west by the R125, to the east by existing sports grounds and The Elms Residential development and to the south by agricultural lands.

The location of the subject Phase 2 North and South development sites is illustrated in Figure 1 below.

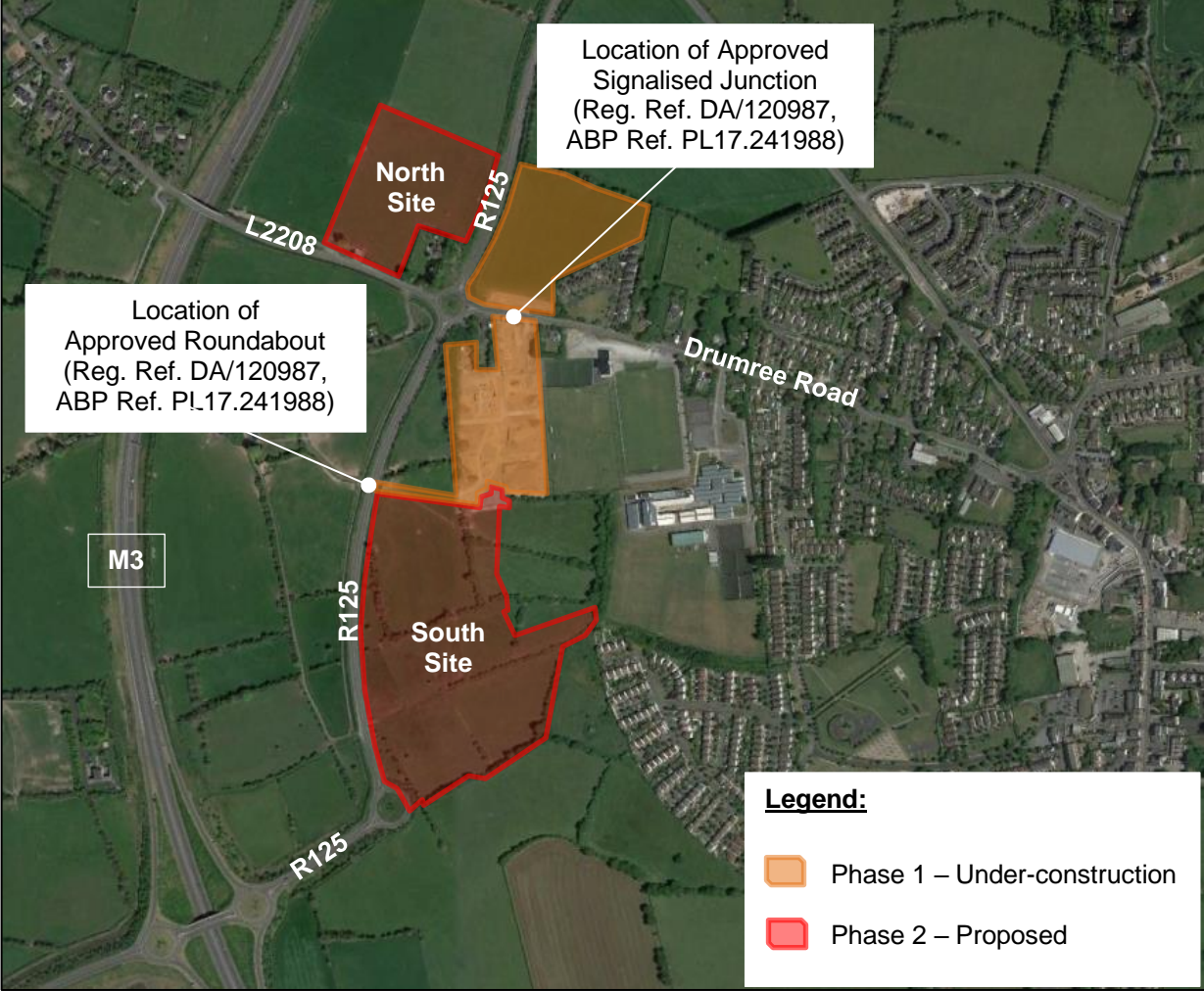

Figure 1 | Location of Proposed (Phase 2) and Under-Construction (Phase 1) Developments.

1.7 Methodology

The methodology for the preparation of this Traffic and Transport Assessment included: -

- Descriptions of the proposed Phase 2 and under-construction Phase 1 developments.
- Descriptions of the receiving environment including roads and junctions, public transport, cycle and pedestrian facilities.
- Description of existing travel characteristics including traffic surveys.
- Description of proposed transportation improvements to roads, junctions, public transport, cycle and pedestrian facilities.

- Calculation of trip generation and distribution for proposed Phase 2, under-construction Phase 1 (Reg. Ref. DA120987, ABP Ref. PL17.241988) and potential Neighbourhood Centre developments.
- Determination of future traffic movements in 2024, 2029 and 2039.
- Determination of transportation impact on roads and junctions.

1.8 Program

It is expected that construction of the proposed Phase 2 development, both North and South Sites, will commence in 2021 for completion in 2024.

1.9 Assessment Years

In compliance with Section 3.3 of the Traffic and Transport Assessment Guidelines (May 2014), the traffic effects of the proposed development have been assessed for the following years.

Base Year	:	2020
Opening Year (With / Without Development)	:	2024
Opening Year + 5 Years Forecast (With / Without Development)	:	2029
Opening Year + 15 Years Forecast (With / Without Development)	:	2039

1.10 Assessment Junctions

For the purpose of this Traffic and Transport Assessment, the junctions that have been assessed are as follows:

Junction 1 (Existing Signalised Crossroads): R147 Navan Road / R125 / Drumree Road.

Junction 2 (Existing Priority-controlled Crossroads): R147 Navan Road / Lagore Road.

Junction 3 (Existing Priority-controlled Roundabout): R125 / L2208 / Drumree Road.

Junction 4 (Approved Signalised Crossroads): Drumree Road / Access Roads to Phase 1.

Junction 5 (Approved Priority-controlled Roundabout): R125 / Access Road to Phase 1.

Junction 6 (Proposed Priority-controlled T-junction): L2208 / Access Road to Phase 2 North Site.

Junction 7 (Proposed Upgraded Roundabout): R125 / Access Road to Phase 2 South Site.

The location of each assessed junction is presented in Figure 2 below.

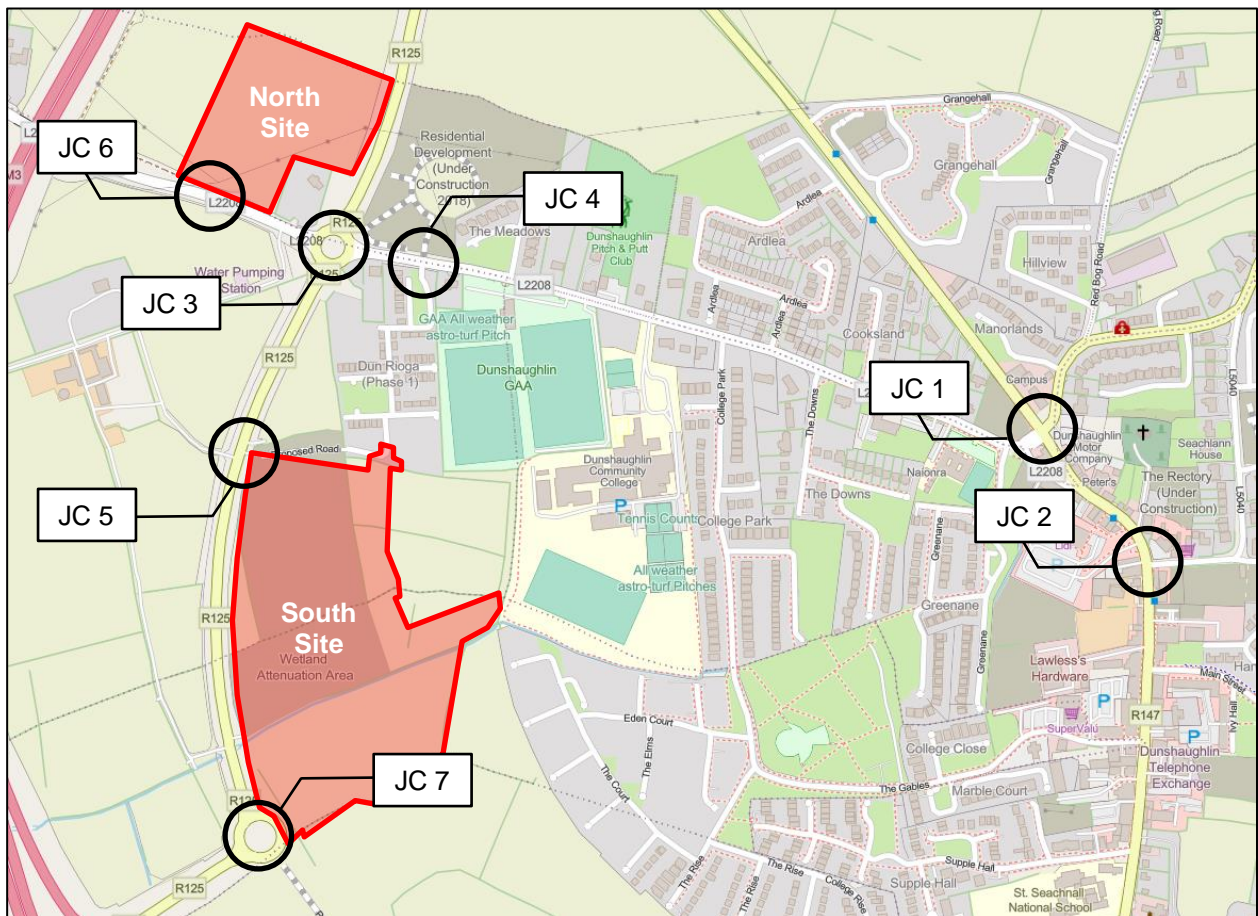

Figure 2 | Location Map for Assessed Junctions.

1.11 Assessment Site Layouts

As part of the subject Traffic and Transport Assessment, two proposed site layouts have been assessed.

Layout Option 1 comprises a total of 415 No. residential units and a creche facility, to be developed in two distinct areas, the labelled North Site and South Site as presented in Section 1.1 above. Vehicular access to the North Site will be provided via L2208 whilst vehicular access to South Site will be provided from west via Junctions 5 and 7 and from north - across the under-construction Phase 1 development, via Junction 4.

For this layout, a vehicular connection link across the F1 Zoned Lands in the South Site is proposed. With this vehicular connection link in place, the South Site will be completely connected internally which will allow all South Site residents to access the site via Junctions 4, 5 and 7.

Layout Option 2 comprises of a small change in the layout of the proposed South Site which consists of the downgrade of the vehicular connection across the F1 Zoned Lands to allow pedestrian and cyclist movements only. There are no other changes proposed to Layout Option 2 as compared to Layout Option 1. The number and location of the proposed units remains the same under both layout options.

Without the vehicular connection link across the F1 Zoned Lands, the proposed South Site has been separated into two portions with regards to vehicular access and movements, the labelled South Site – North Portion (to the north of the F1 Zoned Lands) with vehicular access provided via Junctions 4 and 5,

and the labelled South Site – South Portion (to the south of the F1 Zoned Lands) with vehicular access provided via Junction 7.

The assessment of Layout Option 1, which is the preferred option, is presented in the body of the subject TTA, whilst the assessment of Layout Option 2 is included in Appendix D.

2. Policy Framework

2.1 Meath County Development Plan (2013 – 2019)

The Meath County Development Plan (2013 – 2019) sets out the policies and objectives for the development of the County for the period of 2013 to 2019. The Plan seeks to improve and expand in a sustainable manner the social, economic, cultural and environments assets of the county. In the perspective of the subject development sites and the proposed residential scheme some pertinent principles, strategic policies and objectives include:

2.1.1 Development Plan Core Principles

“Core Principle 9: *To consolidate population growth and employment in areas best served by public transport and a range of transport modes.”*

“Core Principle 10: *To promote and support the integration of land use and transport and a modal shift to greater use of sustainable modes of transport, including public transport, walking and cycling”*

2.1.2 Settlement Strategy

“Moderate Sustainable Growth Towns – Dunshaughlin (SS OBJ 11): *To ensure that Moderate Sustainable Growth Towns develop in a self sufficient manner with population growth occurring in tandem with physical and social infrastructure and economic development. Development should support a compact urban form and the integration of land use and transport.”*

2.1.3 Transportation

“TRAN SP 1: *To support the sustainability principles set out in national and regional policy documents and guidelines and to ensure that land use and zoning are integrated with transportation, especially along public transport nodes/corridors and at accessible urban sites as recognised in the Core Strategy.”*

“TRAN SP 2: *To promote the sustainable development of walking, cycling, public transport and other more sustainable forms of transport as an alternative to the private car, together with the development of the necessary infrastructure and promotion of the initiatives contained within ‘Smarter Travel, A Sustainable Transport Future 2009 – 2020.’*

“TRAN SP 6: *To promote higher residential development densities within the Large Growth Town I and II and Moderate Sustainable Growth Towns, as promoted by the Department of Environment Community and Local Government’s ‘Guidelines for Planning Authorities on Sustainable Residential Development in Urban Areas’ so as to support viable public transport services.”*

“TRAN SP 10: *To facilitate alternative transport modes to the private car, including good transport links between Designated Towns (as defined in the NTA’s draft Transport Strategy) and Dublin City centre; frequent local bus services linking residential areas to District Centres and Designated Towns, and which serve shopping areas, employment areas and other activity centres, and connecting to key transport interchange points.”*

“TRAN POL 14: *To co-operate with the NTA on the development of a cycle network for the greater Dublin Area and to promote, enhance and provide the development of cycling and walking facilities in the County in accordance with relevant national policy and guidelines.”*

“TRAN POL 15: To identify and seek to implement a strategic, coherent and high quality cycle and walking network across the county that is integrated with public transport and interconnected with cultural, recreational, retail, educational and employment destinations and attractions.”

“TRAN POL 16: To encourage, where appropriate, the incorporation of safe and efficient cycleways, accessible footpaths and pedestrian routes into the design schemes for town centres/neighbourhood centres, residential, educational, employment, recreational developments and other uses.”

“TRAN POL 21: To make provision for cycle lanes as part of road improvement / redesign schemes on identified cycle networks, consistent with the NTA National Cycle Manual.”

“TRAN POL 23: To require planning applications for major developments to demonstrate proposals to address accessibility for pedestrian and cyclists.”

2.1.4 Dunshaughlin Zoning Map

In the Meath County Development Plan 2013 – 2019, the subject Phase 2 development sites are zoned for ‘**A2:** To provide for new residential communities with ancillary community facilities, neighbourhood facilities and employment uses as considered appropriate for the status of the centre in the Settlement Hierarchy’ – refer to Figure 3 below which shows an extract taken from the Dunshaughlin Zoning Map within the Development Plan.

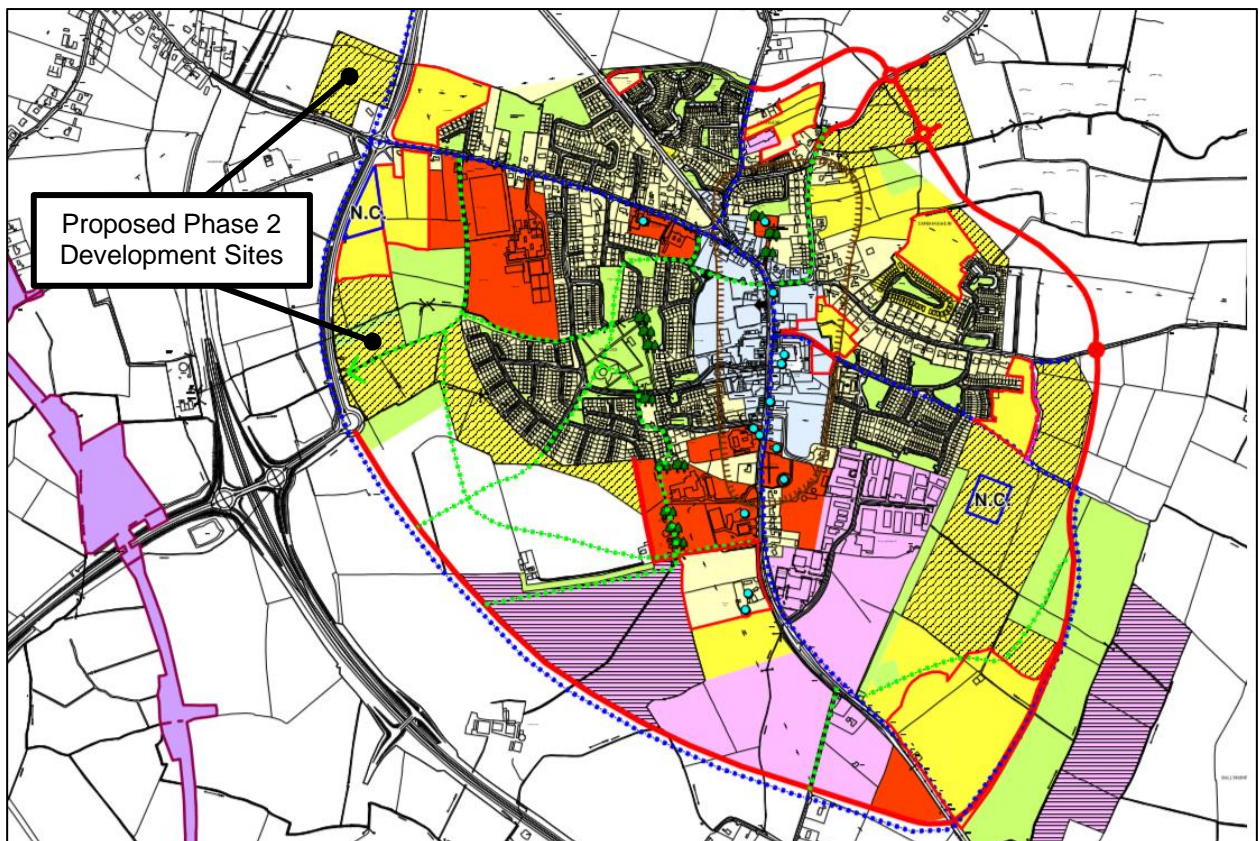

Figure 3 | Location of Proposed Phase 2 Development – Dunshaughlin Zoning Map.

3. Receiving Environment

3.1 Existing Roads and Junctions

3.1.1 Roads

Dunshaughlin is well served by a number of regional roads as well as being directly east of the M3 motorway. The M3 is the main regional road linking Dublin to Cavan. Access from the proposed development sites to the M3 can be achieved via the R125 Dunshaughlin Link Road without the need to pass through Dunshaughlin Town Centre.

The existing roads which provide direct access to the proposed development sites are R125 Dunshaughlin Link Road, L2208 and Drumree Road.

R125 is a regional road running for approximately 45km linking Kilcock on County Meath/County Kildare border to Swords in County Dublin via Dunshaughlin and Ratoath towns. The speed limit along the R125 adjacent to the proposed development sites (North and South sites) is 80kph. This road is approximately 1.4km in length from the roundabout immediately southwest of the proposed South Site through to a roundabout with R147. Along this section, R125 comprises a carriageway of 7.5m wide with no footpaths or cycle lanes provided.

L2208 is a local road running for approximately 2.8km from Killeen Road through to a roundabout with R125 and Drumree Road. The speed limit along the L2208 adjacent to the proposed North Site is 80kph. Along this section, L2208 comprises a carriageway of 7.5m with footpaths running along both sides and no cycle lanes provided.

Drumree Road is a single carriageway road running east-west for approximately 850m from the signalised junction with R147 Navan Road through to the roundabout with R125 and L2208. This road, which provides the main access to the under-construction Phase 1 development, currently comprises a carriageway of approximately 7.30m with footpaths running along both sides of the road and no cycle lanes provided.

The road layout in the area surrounding the proposed development sites is illustrated in Figure 4.

3.1.2 Junctions

The existing surrounding road network junctions which currently provide access to the proposed Phase 2 development sites are:

- **Junction A (Existing Four-armed Roundabout):** R125 / Drumree Road / L2208;
- **Junction B (Existing Two-armed Roundabout):** R125;
- **Junction C (Existing Signalised Crossroads):** Drumree Road / R147 / R125.

The location of each existing main junction in relation to the proposed Phase 2 development sites is illustrated in Figure 4 below.



Figure 4 | Existing Road Network and Main Junctions.

3.2 Existing Public Transport

3.2.1 Bus

The proposed development sites are not directly served by any public bus service. The closest public bus stops are located in Dunshaughlin Town Centre, approximately 1km east of the sites. These bus stops are served by three bus routes, being Routes 109, 109A and 109B. These routes are operated by Bus Eireann and connect Dunshaughlin to Dublin Airport, to Dublin City Centre and to Busaras Terminal. On the opposite direction, these routes connect Dunshaughlin to Navan, Kells and Trim. A summary of the peak hour frequencies of these Bus Eireann Routes is presented in Table 1.

Access from the proposed development sites to the subject bus stops in Dunshaughlin Town Centre is via Drumree Road. From the proposed South Site, the bus stops in town centre will also be accessed via the potential greenway along Skane River. The location of the subject bus stops in relation to the proposed development sites is illustrated in Figure 5.

Route No.	Bus Eireann Service Route	Peak Hours Frequency
109	Dublin – Dunshaughlin – Navan - Kells	30 minutes
109A	Dublin Airport / City Centre – Ashbourne – Ratoath – Dunshaughlin – Navan – Kells	Hourly
109B	Dublin – Dunshaughlin – Kilmessan – Trim	Every Two Hours

Table 1 | Bus Eireann Service Routes.

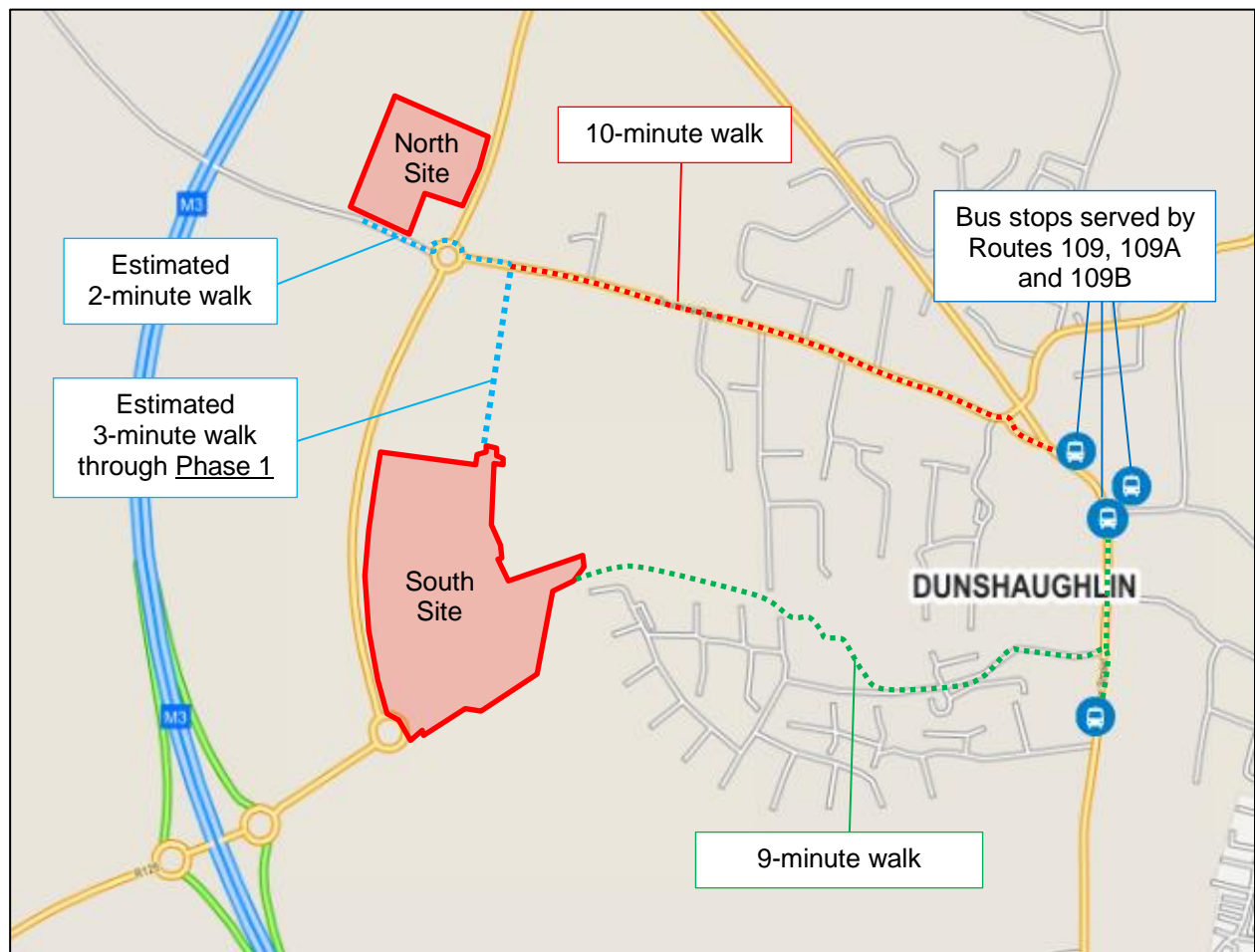

Figure 5 | Location of Closest Bus Stops.

Travel time from the subject bus stops in Dunshaughlin Town Centre to Dublin Airport is approximately 52 minutes and to Busaras Terminal is approximately 55 minutes. On the opposite direction, the travel time from the subject bus stops in Dunshaughlin to Navan is approximately 20 minutes, to Kells is approximately 40 minutes, and to Trim is approximately 32 minutes.

3.2.2 Rail

The proposed development site is located approximately 12,5km north of the closest train station - M3 Parkway, which is the terminus of the Docklands to M3 Parkway Western Commuter service.

The Commuter Rail service through M3 Parkway Station serves all stations from Docklands to M3 Parkway. The service operates at 3 – 4 services per hour on weekdays.

The M3 Parkway Station comprises c. 1,200 free park and ride spaces. These spaces currently provide the opportunity for those living in the surrounding villages and towns to commute by a car-train combined travel and to shift away from car-based travels to Dublin City.

Primary vehicular access to the M3 Parkway Station is via M3 (10-minute drive) with an alternative parallel route via R147 (15-minute).

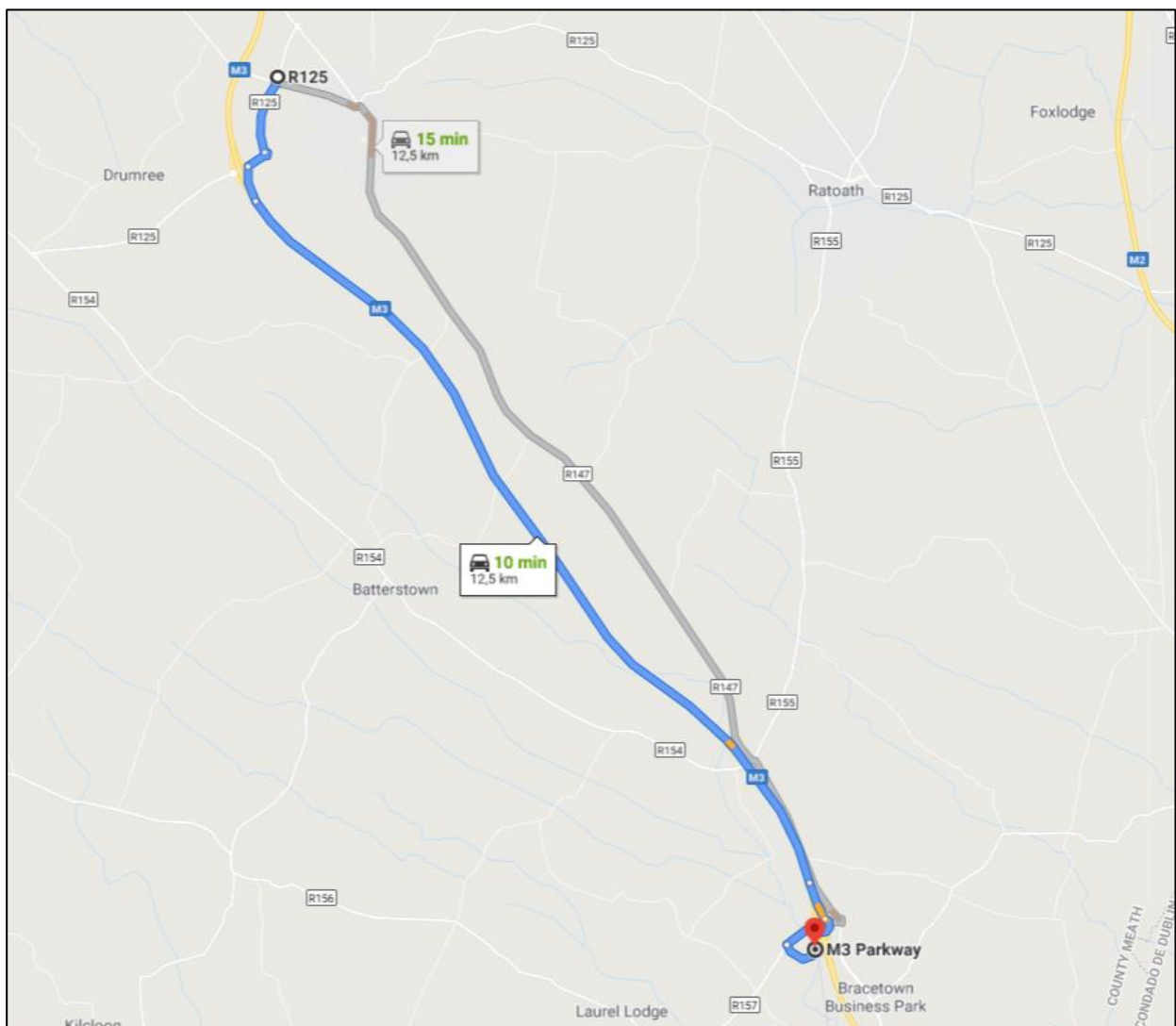

Figure 6 | Driving Route from Proposed Development Sites to M3 Parkway Station.

3.3 Existing Cycle Facilities

With regards to cycle facilities, Figure 7 below illustrates the local cycle network as taken from the National Transport Authority's (NTA) Greater Dublin Area Cycle Network Plan.

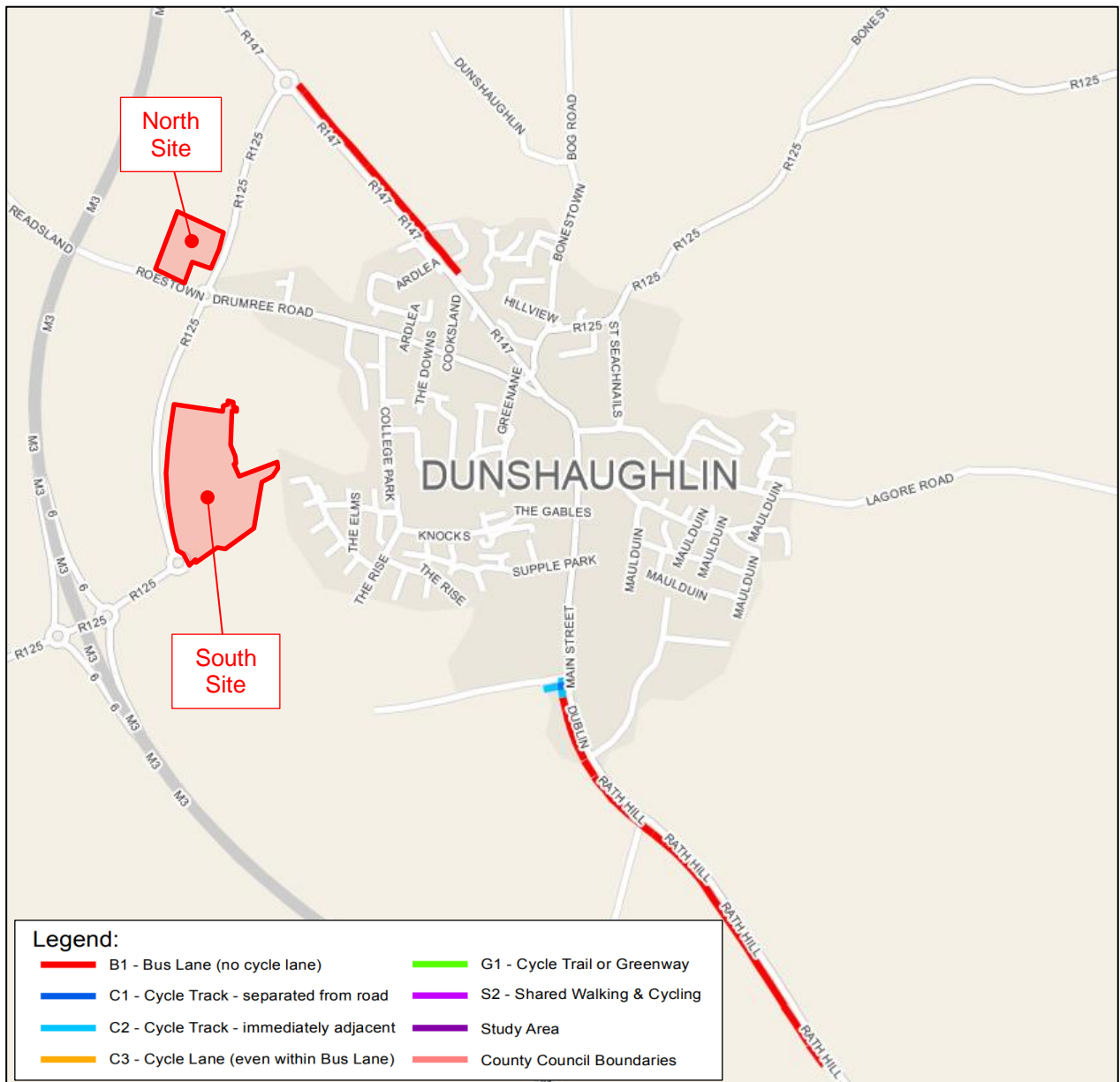

Figure 7 | Existing Cycle Facilities Map – Sheet E15, Extracted from GDA Cycle Network Plan.

As can be seen from the above, there is no existing cycle lanes provided in Dunshaughlin.

As part of the Phase 1 development approved under Reg. Ref. DA/120987, ABP Ref. PL17.241988 a network of off-road cycle lanes running south-north along both sides of the spine road within the development is currently under construction nearing completion. These nearly complete cycle lanes across

Phase 1 development is a key element which will facilitate safe cyclist progression from the proposed South Site of Phase 2 towards Drumree Road.

3.4 Existing Pedestrian Facilities

To the south of the proposed North Site, along the L2208, pedestrians can benefit from the provision of footpaths directly adjacent to the road along both sides of the carriageway.

Two pedestrian crossings on the northern and southern approaches of the R125 / Drumree Road / L2208 roundabout are currently provided. These existing pedestrian crossings, which currently facilitate pedestrian progression from the proposed North Site towards Drumree Road and the town centre, include dropped kerbs and tactile paving facilities. However, due to notable traffic speeds at the subject roundabout, Meath County Council recognises that *“the current footpath provision and crossings points are not to an acceptable level to cater for the future pedestrian and cycle demand that the proposed development will likely generate”*.

Along the South Site frontage, the R125 has a speed limit of 80kph with no footpaths provided.

As part of the approved Phase 1 development, a network of footpaths with dedicated pedestrian crossings at various points is currently under construction (nearing completion) within the development site such that unimpeded and safe pedestrian movement is facilitated. This nearly complete network of footpaths is a key element to facilitate pedestrian progression from the proposed South Site (Phase 2) towards Drumree Road. Details of the upgraded footpaths nearly complete as part of Phase 1 development are shown on Waterman Moylan Drg. No. 12-081A-P183 accompanying the documentation package.

The existing pedestrian facilities along Drumree Road comprise a network of footpaths linking the various neighbourhoods to each other, to the existing schools, to the existing bus stops (Refer to Figure 5 for bus stops location), to the Dunshaughlin town centre and to the surrounding public network.

Pedestrian routes from the proposed North and South Sites to the closest bus stops and the town centre is via Drumree Road with a potential route via Skane River greenway as presented in Section 3.2.1 of this report.

3.5 Traffic Survey

In order to identify the volumes of traffic movements at the key junctions on the road network surrounding the subject sites, a set of classified turning movement traffic counts were commissioned.

A manual classified traffic survey was carried out by ‘IDASO’ on Tuesday 25th February 2020 at one signalised crossroads, one priority-controlled crossroads and one roundabout over a period of 24 hours. The junctions surveyed were:

- **Junction 1 (Signalised Crossroads):** R147 Navan Road / R125 / Drumree Road.
- **Junction 2 (Priority-controlled Crossroads):** R147 Navan Road / Lagore Road.
- **Junction 3 (Priority-controlled Roundabout):** R125 / L2208 / Drumree Road.

The location of the surveyed junctions in relation to the proposed development sites is illustrated in Figure 8 below.

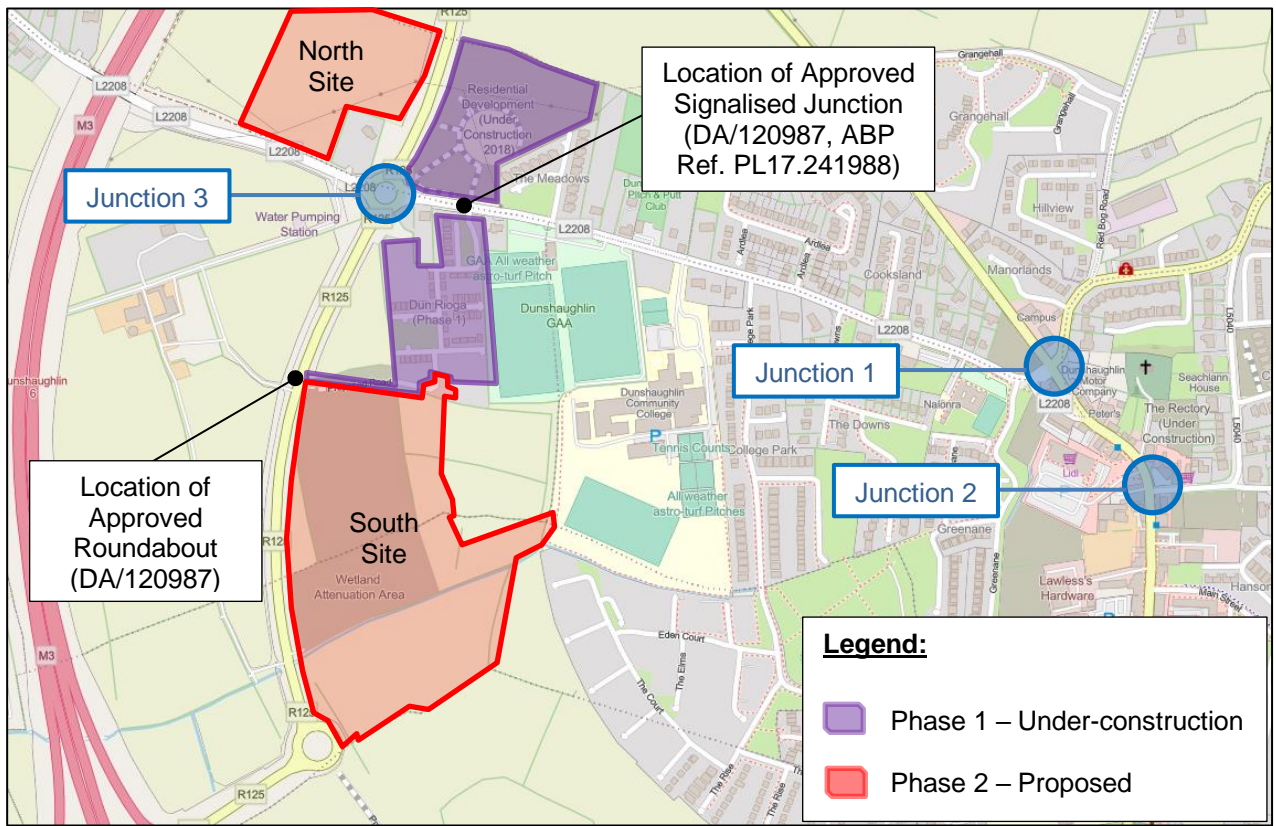

Figure 8 | Location of Surveyed Junctions.

The survey identified the AM peak hour as 08h00 - 09h00 and the PM peak hour as 17h00 – 18h00 for all junctions. The surveyed peak hour volumes are illustrated in Figure 9 below. The complete traffic survey is included in Appendix A.

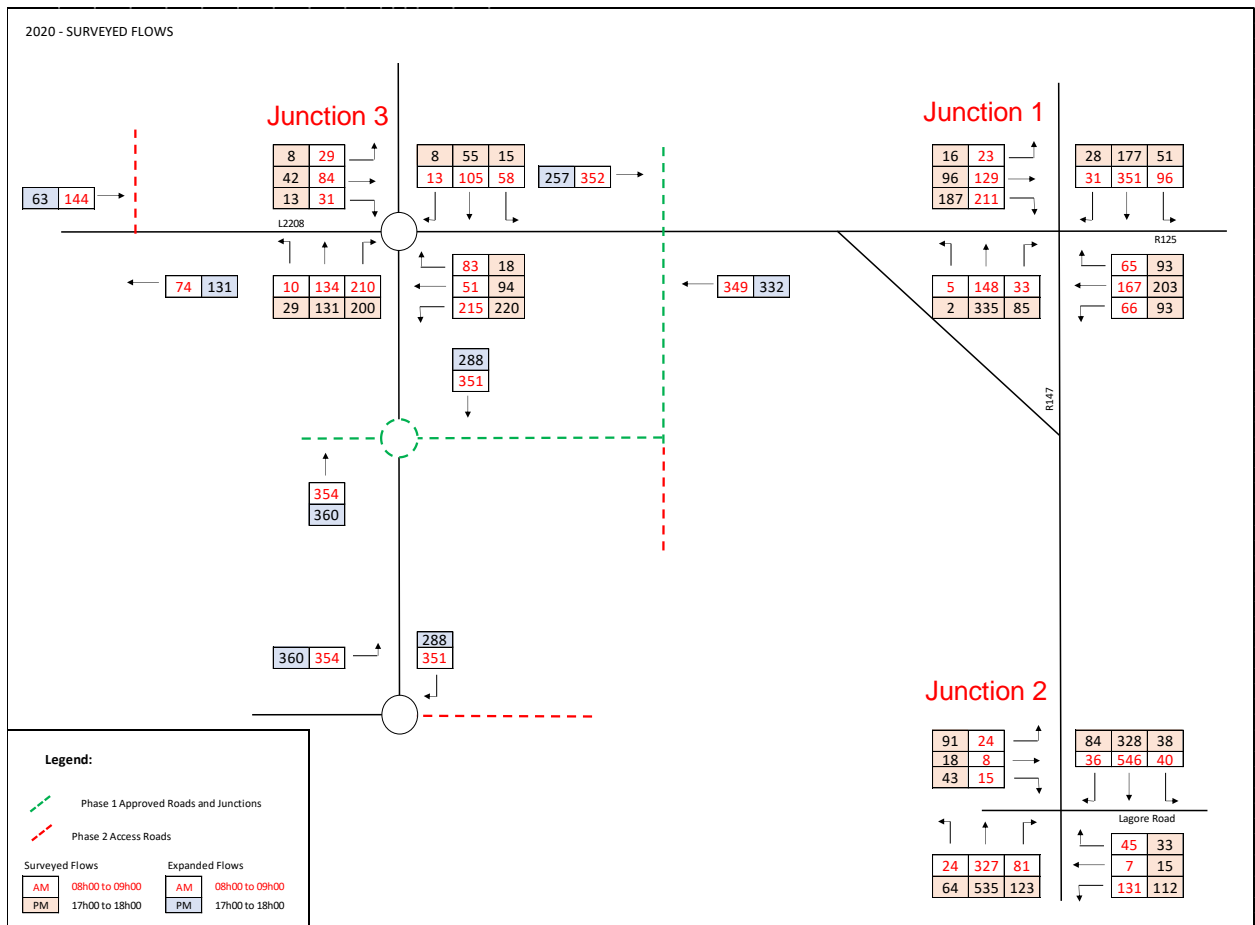

Figure 9 | Surveyed AM and PM Peak Hour Flows – February 2020.

4. Transportation Improvements

4.1 Roads and Junctions

4.1.1 Drumree Road / Phase 1 Site Access Roads (Signalised Junction)

As part of the approved Phase 1 development works (Reg. Ref. DA/120987), a signalised junction on Drumree Road (approximately 80m east of the existing roundabout with R125 and L2208) is currently under construction, with the access roads to Phase 1 forming the northern and southern arms of the junction.

The under-construction scheme comprises:

- New northern and southern approaches of the junction to provide controlled access to the under-construction Phase 1 development;
- Installation of a new traffic signal infrastructure with 4 normal traffic stages and 1 pedestrian stage;
- Dedicated signalised pedestrian crossings (toucan) with dropped kerbs and tactile paving on all approaches;
- A dedicated right-turning pocket lane on the Drumree Road Western Approach;
- Improvements to the existing footpaths on both sides of Drumree Road along the Phase 1 site frontage.

The under-construction scheme also includes widening the Drumree Road along the Phase 1 site frontage to provide enough space for cycle lanes on both side of the carriageway. Provision of cycle lanes on Drumree Road is part of the overall cycle network scheme proposed for Dunshaughlin under GDA Cycle Network Plan (See Figure 11).

It is proposed that the South Site development of Phase 2 will be interconnect with the under-construction Phase 1. Therefore, the subject signalised junction will also provide access to the proposed South Site development of Phase 2.

The location of the under-construction junction in relation to the proposed Phase 2 development sites is illustrated in Figure 10.

4.1.2 R125 Dunshaughlin Link Road / Phase 1 Site Access Road (Roundabout)

The overall proposal of the approved development of Phase 1 (DA/120987) also includes the construction of a four-armed roundabout on R125 (approximately 260m south of the existing roundabout with L2208 and Drumree Road) with the access road to Phase 1 forming the eastern arm of the roundabout. This access road will comprise cycle lanes along both sides and will also provide access to the South Site of the proposed Phase 2 development.

The location of the approved roundabout in relation to the proposed Phase 2 development sites is illustrated in Figure 10.

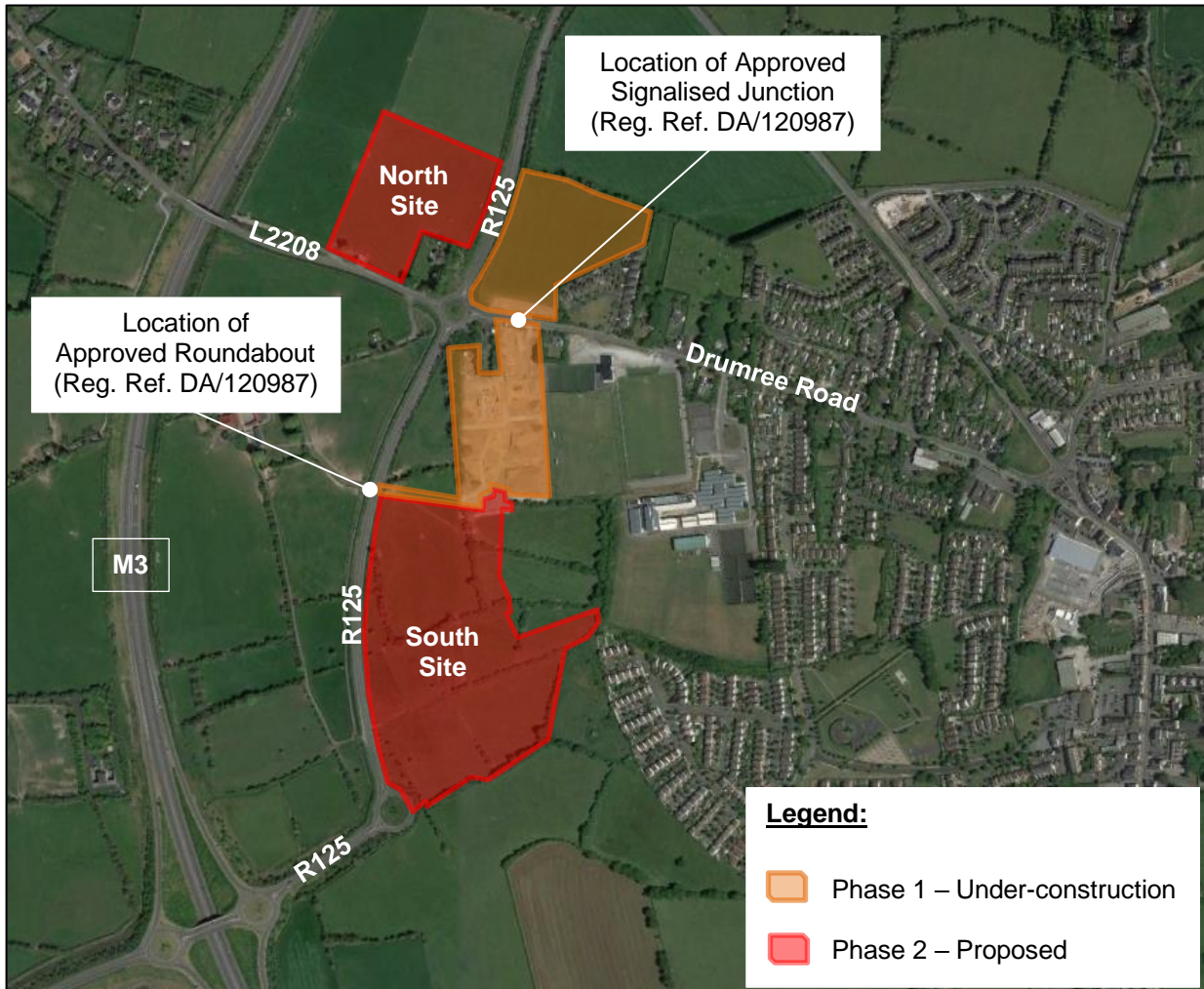

Figure 10 | Location Map for Phase 1 Approved Junctions.

4.2 Public Transport

4.2.1 DART Expansion Programme and Heavy Rail Line Extension to Navan

The DART Expansion Programme is included within the 10-year horizon for the National Development Plan 2018 – 2027. It includes for provision of fast, high-frequency and electrified service from Docklands to M3 Parkway line. The programme’s ambitions are to increase train frequency to a 5-minute all day frequency and to lengthen all trains to eight carriages.

The extension of the Dunboyne line between Clonsilla and M3 Parkway Stations onwards to north Navan was previously proposed as part of the Transport 21 plan announced by the Irish Government in 2005. This extension was assessed as part of the examination of the Corridor B (Navan – Dunboyne – Blanchardstown – to Dublin City Centre) under the Transport Strategy for the Greater Dublin Area 2016 – 2035, and in summary, it was recognised by the National Transport Authority that, “*the level of travel demand between Navan, Dunshaughlin and various stations to the city centre is insufficient to justify the development of a high-quality rail link at this time*”. However, it is anticipated by the NTA that the extension of the railway line

- **“Route Du2:** *Drumree Road, Dunshaughlin (potential link to the proposed future railway station west of the town) and Lagore Road linking eastward to Ratoath on a quiet rural route that is more suitable for cycling than the R125.”*

As described earlier in Section 3.3 of this report, as part of the under-construction Phase 1 development (Reg. Ref. DA/120987), a network of off-road cycle lanes running south-north along both sides of the spine road within the development is currently under construction nearing completion. The overall approved proposal for Phase 1 also includes widening the Drumree Road along the Phase 1 site frontage to accommodate a small portion of the Cycle Route Du2 along both sides of the carriageway as proposed under the Greater Dublin Area Cycle Network Plan. These nearly complete network of cycle lanes provided as part of Phase 1 development is a key element which will facilitate safe cyclist progression from the proposed South Site of Phase 2 towards the future Cycle Route Du2 on Drumree Road.

4.4 Pedestrian Facilities

As described earlier in Section 3.4 of this report, as part of the under-construction Phase 1 development approved under Reg. Ref. DA/120987, a network of footpaths with dedicated pedestrian crossings at various points is currently under construction (near completion) within the development such that unimpeded and safe pedestrian movement is facilitated. This nearly complete network of footpaths is a key element which will facilitate pedestrian progression from the proposed South Site (Phase 2) towards Drumree Road.

As part of the proposed development works of Phase 2, it is proposed to renovate the existing pedestrian facilities along the L2208 and Drumree Road from the access point to the North Site up until the pedestrian facilities currently under construction as part of the Phase 1 development works (Reg. Ref. DA/120987). These proposed pedestrian facilities include a new pedestrian crossing on the northern arm of the Drumree Road / R125 / L2208 roundabout, which will facilitate safe pedestrian progression from the North Site towards Drumree Road, the local schools and GAA grounds. Details of the proposed works on L2208 and Drumree Road are shown on Waterman Moylan Drg No's 12-081A-P180, 12-081A-P181, 12-081A-P182 and 12-081A-P183 accompanying the documentation package.

5. Proposed Development

5.1 Development Description

The proposed development is the second phase of a larger development located adjacent to R125 Dunshaughlin Link Road approximately 1.0km west of Dunshaughlin Town Centre.

Phase 1 of the overall development was approved by Meath County Council in April 2013 under Reg. Ref DA/120987 and is currently under construction nearing completion.

The proposed Phase 2 comprises a total of 415 No. residential units (254 houses, 55 duplexes and 106 apartments) and a Creche to accommodate a total of 80 children and 16 staff on site.

Phase 2 is proposed to be developed in two distinct areas, one to the north of L2208 and west of R125 (labelled as North Site) and the other to the south of the approved Phase 1 and east of R125 (labelled as South Site) as per Figure 12 below.



Figure 12 | Location of Proposed (Phase 2) and Under-construction (Phase 1) Developments.

The **North Site** is approximately 4.3 Ha in area and will comprise:

- 95 No. houses;
- 20 No. duplexes, and
- 34 No. apartments.

The **South Site** is approximately 10.5 Ha in area and will comprise:

- 159 No. houses;
- 35 No. duplexes;
- 72 No. apartments, and
- A Creche with 413 sqm of area (80 children and 16 staff).

The proposed Phase 2 development (North and South Sites) is programmed to be fully constructed and occupied by 2024.

5.2 Site Access Points

5.2.1 North Site

Vehicular access to the North Site is proposed from L2208 via a new priority-controlled T-junction. The visibility splay requirements for this junction are based on the 50kph design speed limit. The sightline requirements for a new priority junction on a 50kph road are identified within the Design Manual for Urban Roads and Streets (DMURS) which recommends a visibility splay of 45m x 2.4m. Approximately 35 metres east of this proposed vehicular entrance, a pedestrian only access point will also be provided on L2208.

Further details can be seen on Waterman Moylan drawings accompanying the documentation package.

5.2.2 South Site

The proposed South Site development will benefit from a number of access points. To the north, the South Site will link directly to the under-construction Phase 1 (Reg. Ref. DA/120987) which currently benefits from two access points, one off Drumree Road via a new signalised junction and one off R125 via a new as yet unconstructed roundabout. One further access point will be provided via the existing two-armed roundabout on R125 - at the southwestern edge of the site, which is proposed to be updated to a three-armed roundabout with the site access road forming the eastern arm. An allowance for future traffic and pedestrian links has also been proposed to facilitate a connection between the South Site and any potential future development to the east and south of the subject South Site.

Further details can be seen on Waterman Moylan drawings accompanying the documentation package.

5.3 Internal Layout

All internal roads in the proposed development (North and South Sites) are designed for a speed limit of 30kph with 5.0m wide carriageways and footpaths along both sides. All intersections within the development itself will be priority junctions with raised tables where appropriate. The low design speeds and traffic calming measures will ensure the desirable operation of these junctions and a safe/secure environment for pedestrians and cyclists.

The design and layout of the proposal has been prepared to fully comply with the current relevant design standards and specifications applicable to this form of development.

5.4 Pedestrian and Cyclist Infrastructure

All footpaths proposed for the subject development (North and South Sites) will be provided in accordance with Section 4.3.1 of the DMURS which suggests that a minimum 1.8m footpath should be provided. All the proposed cycle tracks are designed in accordance with the National Cycle Manual. These proposed pedestrian/cycle facilities will connect to the existing/under-construction facilities in the vicinity of the sites and will provide a good quality and safe/secure network for pedestrians and cyclists.

5.4.1 North Site

As part of the North Site development works, it is proposed to renovate the existing pedestrian facilities along the L2208 from the vehicular access point to the North Site up until the pedestrian facilities currently under construction on Drumree Road as part of the Phase 1 development works (Reg. Ref. DA/120987). This proposed renovation includes a shared cycle/pedestrian facility along the North Site frontage onto L2208 and a new pedestrian crossing with dropped kerbs and tactile paving on the northern arm of the Drumree Road / R125 / L2208 roundabout, and will provide safe pedestrian and cyclist progression from the North Site towards Drumree Road, the local schools and GAA grounds.

5.4.2 South Site

The pedestrian/cyclist infrastructure proposed for the South Site consist of two north-south spines running along the western and eastern sides of the site and one west-east spine running along the north side of the Skane River. All proposed spines will be interconnected internally on site and externally with Phase 1, with dedicated cycle lanes and pedestrian routes to ensure a safe/secure and attractive environment is provided for residents traveling in or outside the site.

In addition, allowances for future pedestrian/cycle links has also been provided at the eastern end of the west-east spine and at the southern ends of the north-south spines to facilitate a connection between the South Site and any potential future development to the east and south. These east and south extension of these pedestrian/cycle facilities are in line with the '*Dunshaughlin Land Use Zoning Objectives Map*' within the Meath County Council Development Plan 2013 – 2019 and will provide a future enhanced network for pedestrians and cyclist traveling east towards the town centre and south outside the South Site area.

Further details on proposed cycle and pedestrian facilities can be seen on enclosed Waterman Moylan Drg. No. 12-081A-P160.

The Skane River greenway will extend further east outside the proposed South Site development boundary and will continue along the river within adjoining lands towards The Park. The proposed greenway alignment and legal ownership boundaries are shown on O'Mahony Pike Drg No. 1214A-OMP-00-ST-DR-A-1903 accompanying the documentation package. A letter of commitment to the greenway delivery from the adjoining landowner is also included as part of the submitted documents.

6. Trip Generation

6.1 TRICS – Trip Rates

In order to assess the likely impact of the traffic generation arising from the proposed Phase 2 development, TRICS software has been consulted. TRICS is the national standard of trip generation and analysis in Ireland. It is a database system which allows users to identify representative trip rates and to establish potential levels of trip generation for a wide variety of developments.

Full trip rates for each proposed land use, which were sourced from the TRICS version 7.7.1, have been provided in Appendix B and are summarised in Table 2 below.

Land Use	Calculation Factor	AM Peak Hour (08h00 to 09h00)		PM Peak Hour (17h00 to 18h00)	
		Arr.	Dep.	Arr.	Dep.
Houses / Duplexes	per dwelling	0.295	0.674	0.432	0.253
Apartments	per dwelling	0.046	0.241	0.212	0.055
Creche	per 100sqm	5.946	3.271	3.766	5.055

Table 2 | TRICS Trip Rates – AM and PM Peak Hours.

6.2 Proposed Development – Phase 2

The calculated vehicular trips for the proposed Phase 2 residential development (North and South Sites) based on the trip rates in Table 2 are presented below.

6.2.1 North Site

As presented earlier in Section 5.1, the proposed North Site will consist of 95 No. Houses, 20 No. Duplexes and 34 No. Apartments. The estimated car trip generation for the proposed North Site is shown in Table 3 below.

Land Use	No. Units	AM Peak Hour (08h00 to 09h00)		PM Peak Hour (17h00 to 18h00)	
		Arr.	Dep.	Arr.	Dep.
Houses / Duplexes	115 units	34	78	50	29
Apartments	34 units	2	8	7	2
Total	149 units	36	86	57	31

Table 3 | AM and PM Peak Hours - Car Trip Generation – North Site of Proposed Phase 2.

As can be seen from the above, the proposed North Site is expected to generate a total of 122 vehicle movements in the AM peak hour (36 arrivals and 86 departures) and a total of 88 vehicle movements in the PM peak hour (57 arrivals and 31 departures).

6.2.2 South Site

The proposed South Site will consist of 159 No. Houses, 35 No. Duplexes, 72 No. Apartments and a Creche with 413 sqm of area. The estimated trip generation for the proposed South Site is shown in Table 4 below.

Land Use	No. Units / Floor Area	AM Peak Hour (08h00 to 09h00)		PM Peak Hour (17h00 to 18h00)	
		Arr.	Dep.	Arr.	Dep.
		Houses / Duplexes	194 units	57	131
Apartments	72 units	3	17	15	4
Creche	413 sqm	25	14	16	21
Total	266 units 413 sqm	85	162	115	74

Table 4 | AM and PM Peak Hours - Car Trip Generation – South Site of Proposed Phase 2.

As can be seen from the above, the proposed South Site is expected to generate a total of 247 vehicle movements in the AM peak hour (85 arrivals and 162 departures) and a total of 189 vehicle movements in the PM peak hour (115 arrivals and 74 departures).

6.3 Under Construction Development – Phase 1 (DA/120987)

In order to provide a robust assessment of the transportation network in the local area, as per TII guidelines, the under-construction Phase 1 development approved by Meath County Council in April 2013 under Reg. Ref. DA/120987 was also analysed with regards to trip generation and distribution. The permission provided for the construction of 142 of the 160 No. residential units proposed, together with a Creche. As the remaining 18 No. residential units (on the southeast corner of Phase 1) are expected to be permitted in the future under a new planning application, for the purpose of this assessment, and in order to undertake a conservative assessment, the 160 No. residential units + creche have been assessed under Phase 1 development.

The AM and PM peak hour trip rates and the generated traffic from the under-construction Phase 1 development have been extracted from the Traffic Impact Assessment approved as part of the planning application for the site and are presented in Table 5 and Table 6, respectively.

Land Use	Calculation Factor	AM Peak Hour (08h00 to 09h00)		PM Peak Hour (17h00 to 18h00)	
		Arr.	Dep.	Arr.	Dep.
		Residential	per dwelling	0.20	0.41
Creche	per 100sqm	5.163	3.890	1.287	2.907

Table 5 | TRICS Trip Rates – AM and PM Peak Hours – extracted from Approved Phase 1 TIA.

Land Use	No. Units / Floor Area	AM Peak Hour (08h00 to 09h00)		PM Peak Hour (17h00 to 18h00)	
		Arr.	Dep.	Arr.	Dep.
Residential (North)	78 units	16	32	33	21
Residential (South)	82 units	16	34	34	21
Creche (South)	c. 200 sqm	10	8	3	6
Total	160 units c. 200 sqm	42	74	70	48

Table 6 | AM and PM Peak Hours – Car Trip Generation – Under-construction Phase 1.

As can be seen from the above, based on the approved TIA (Reg. Ref. DA/120987), the under-construction Phase 1 development (including both north and south sites) is estimated to generate a total of 116 vehicle movements in the AM peak hour (42 arrivals and 74 departures) and a total of 118 vehicle movements in the PM peak hour (70 arrivals and 48 departures).

6.4 Potential Neighbourhood Centre

Immediately west of the approved South Site of Phase 1 development, a portion of land is zoned for a Neighbourhood Centre (See Figure 13 – extracted from Dunshaughlin Land Use Zoning Objectives Map within Meath County Development Plan 2013 – 2019). In order to provide a complete assessment of the surrounding road network and particularly the new approved and proposed junctions, as part of the subject assessment, a potential Neighbourhood Centre was also assessed with regards to additional traffic. The quantum of development assumed for this potential Neighbourhood Centre was based on the originally proposed mix of uses and floor areas and are set out below as a ‘worst-case scenario’ in terms of potential scale of such facility. These floor areas have been extracted from the approved TIA prepared for Phase 1 (Reg. Ref. DA/120987).

Potential Neighbourhood Centre:

- Offices – 3,248 sqm of area
- Retail Enterprise Units – 1,930 sqm of area
- Café – 250 sqm of area
- Medical Centre – 577 sqm of area
- Leisure Facilities – 1,773 sqm of area

The AM and PM peak hour trip rates and trip generation estimated for the potential Neighbourhood Centre have also been extracted from the TIA prepared for Phase 1 and are presented in Table 7 and Table 8, respectively.

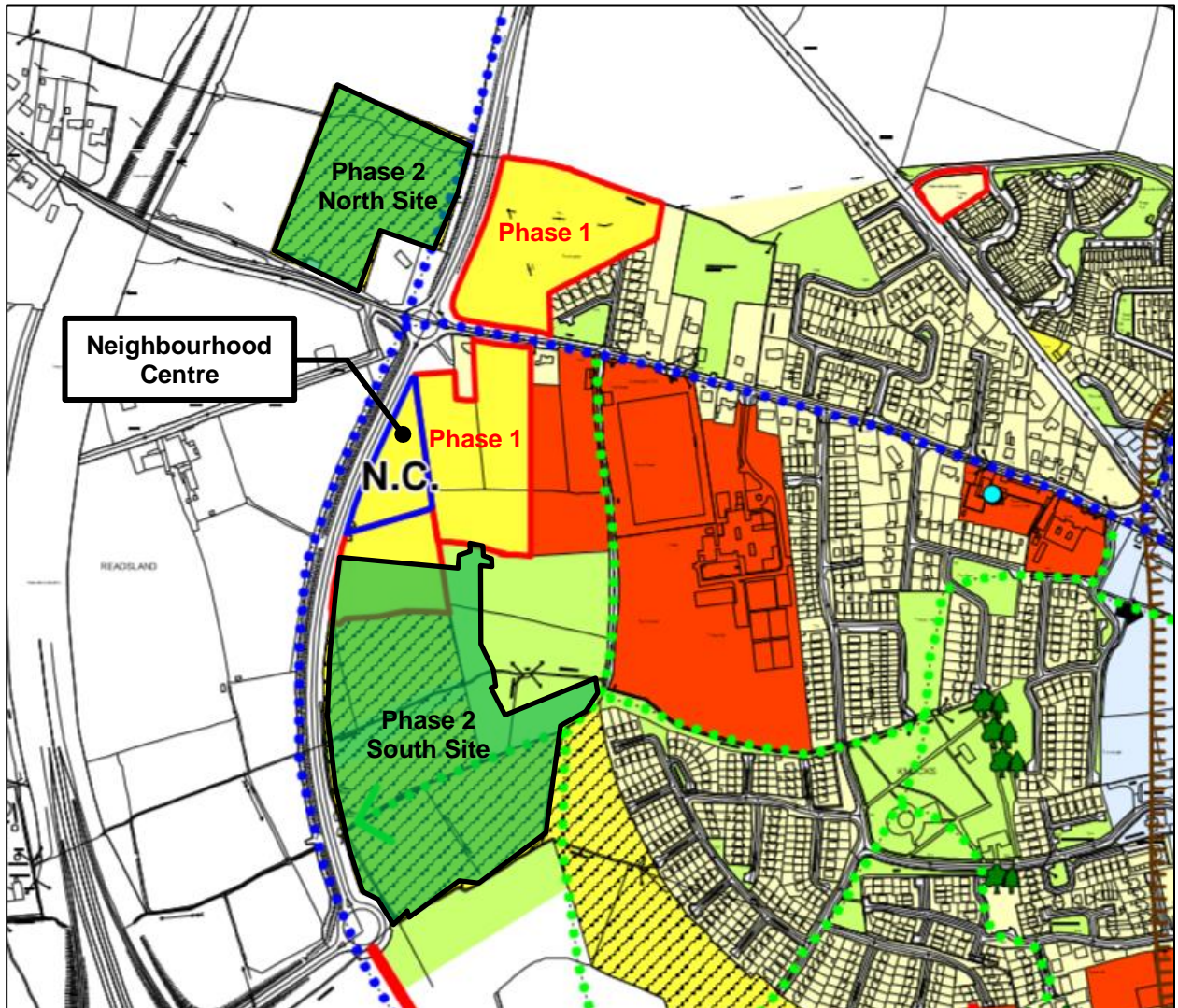

Figure 13 | Location of Neighbourhood Centre – Extracted from Dunshaughlin Zoning Map.

Land Use	Calculation Factor	AM Peak Hour (08h00 to 09h00)		PM Peak Hour (17h00 to 18h00)	
		Arr.	Dep.	Arr.	Dep.
Office	per 100sqm	3.042	0.430	0.225	2.378
Retail	per 100sqm	1.953	1.420	3.521	3.363
Café	per 100sqm	3.399	2.935	4.274	5.458
Medial Centre	per 100sqm	2.140	0.873	3.910	4.650
Leisure Facilities	per 100sqm	0.200	0.410	0.420	0.260

Table 7 | TRICS Trip Rates – AM and PM Peak Hours – extracted from Approved Phase 1 TIA.

Land Use	Floor Area	AM Peak Hour (08h00 to 09h00)		PM Peak Hour (17h00 to 18h00)	
		Arr.	Dep.	Arr.	Dep.
Office	3,248	99	14	7	77
Retail	1,930	38	27	68	65
Café	250	8	7	11	14
Medial Centre	577	12	5	6	11
Leisure Facilities	1,773	9	8	30	23
Total	7,778	166	61	122	190

Table 8 | AM and PM Peak Hours – Car Trip Generation – Potential Neighbourhood Centre.

As can be seen from the above, as per the trip rates and the floor areas extracted from the TIA prepared for Phase 1, in a 'worst-case scenario' the potential Neighbourhood Centre is estimated to generate a total of 227 vehicle movements in the AM peak hour (166 arrivals and 61 departures) and a total of 312 vehicle movements in the PM peak hour (122 arrivals and 190 departures).

For the purpose of this Traffic and Transport Assessment, it is assumed that the potential Neighbourhood Centre will be fully developed and operational any time between 2025 and 2029.

7. Trip Distribution

In order to determine the amount of new car trips expected to travel through each assessed junction in the local road network, the calculated car trips for the proposed Phase 2 development (North and South Sites), for the under-construction Phase 1 and for the potential Neighbourhood Centre, have been distributed.

Vehicular trip distribution for Phase 2 (North and South Sites) has been based on:

- Trip attractor cities and towns such as Navan, Trim, Ashbourne, Dublin and Dunshaughlin.
- The travel patterns identified on the traffic survey carried out as part of the subject assessment.
- The proximity of the proposed development sites in relation to the M3 Motorway.

For the under-construction Phase 1 development and the potential Neighbourhood Centre, vehicular trip distribution has been based on the approved TIA prepared for Phase 1 (Reg. Ref. DA/120987) and slightly amended to reflect the more recent travel patterns identified on the traffic survey.

7.1 Proposed Development – Phase 2

7.1.1 North Site

All estimated traffic to/from the proposed North Site of Phase 2 will access the site via the priority-controlled junction proposed as part of the subject development works.

Based on the analysis of the existing travel patterns and the location of the proposed development in relation to regional roads, to the M3 motorway and to major employment centres, the trip distribution for Phase 2 North Site was assumed as follows:

- 25% to/from Dunshaughlin Town Centre (W), of which
 - 15% to/from south along R147, and
 - 10% to/from east along R125 Ratoath Road towards Ratoath and Dublin Airport.
- 5% via R125 Dunshaughlin Link Road (N) to/from Navan and associated major employments.
- 55% via R125 Dunshaughlin Link Road (S) to/from M3 Motorway, of which
 - 40% south to/from M3 Parkway Rail Station and Dublin City.
 - 15% north to/from Navan and associated major employments.
- 15% via R125 Dunshaughlin Link Road (S) to/from Trim and associated major employments via the bridge over M3 Motorway.

The trip distribution and assignment of the proposed North Site development's vehicular traffic across the local road network are presented in Figure A and Figure B, respectively, as included in Appendix C.

7.1.2 South Site

The estimated traffic to/from the proposed South Site of Phase 2 has been divided between the following 3 No. access points.

- 1) **Access Point 1:** Southern arm of the under-construction signalised junction on Drumree Road - approved under Phase 1 development.

- 2) **Access Point 2:** Eastern arm of the new roundabout on R125 Dunshaughlin Link Road - approved under Phase 1 development.
- 3) **Access Point 3:** Proposed eastern arm of the proposed three-arm roundabout on R125 Dunshaughlin Link Road immediately southwest of proposed Phase 2 South Site.

Access Point 1, which will be accessed via the under-construction Phase 1 development, is assumed to serve 20% of the overall vehicular trips estimated for the South Site of Phase 2. Access Point 2 will serve 50% of the total South Site development traffic whilst the remaining 30% will be served by Access Point 3.

In summary, based on the analysis of the existing travel patterns and the location of the proposed development in relation to regional roads, to M3 motorway and to major employment centres, the trip distribution for Phase 2 South Site was assumed as follows:

- 25% to/from Dunshaughlin Town Centre, of which
 - 15% to/from south along R147, and
 - 10% to/from east along R125 Ratoath Road towards Ratoath and Dublin Airport.
- 10% via R125 Dunshaughlin Link Road (N) to/from Navan and associated major employments.
- 50% via R125 Dunshaughlin Link Road (S) to/from M3 Motorway, of which
 - 40% south to/from M3 Parkway Rail Station and Dublin City.
 - 10% north to/from Navan and associated major employments.
- 15% via R125 Dunshaughlin Link Road (S) to/from Trim and associated major employments via the bridge over M3 Motorway.

The trip distribution and assignment of the proposed South Site development's vehicular traffic across the local road network are presented in Figure C and Figure D, respectively, as included in Appendix C.

7.2 Under Construction Development – Phase 1 (DA/120987)

The AM and PM peak hour vehicular trip distribution for the under-construction Phase 1 development is detailed in Figure E (North Site) and Figure F (South Site) as included in Appendix C. The percentages shown in Figures E and F have been based on the approved TIA prepared for Phase 1 (Reg. Ref. DA/120987) and slightly amended to reflect the more recent travel patterns identified on the traffic survey.

The corresponding AM and PM peak hour traffic flows for the under-construction Phase 1 development (north and south sites), based on the distribution percentages in Figures E and F, are shown in Figure G – Appendix C.

7.3 Potential Neighbourhood Centre

The AM and PM peak hour vehicular trip distribution for the potential Neighbourhood Centre is detailed in Figure H as included in Appendix C. The percentages shown in Figure H have been based on the approved TIA prepared for Phase 1 (Reg. Ref. DA/120987) and slightly amended to reflect the more recent travel patterns identified on the traffic survey.

The corresponding AM and PM peak hour traffic flows for the potential Neighbourhood Centre, based on the distribution percentages in Figure H, are shown in Figure I – Appendix C.

8. Traffic Growth and Permitted Developments in Dunshaughlin

8.1 Traffic Growth

It has been assumed within this Traffic and Transport Assessment for the subject Phase 2 (North and South Sites) that the development will be fully constructed over a period of approximately 4 years. Therefore, the assumed year of opening is 2024.

As per methodology adopted in the NRA Transport Assessment Guidelines (2014), which this TTA is based on, the analysed junctions were also assessed for the future design years of 2029 (Opening Year + 5 years) and 2039 (Opening Year + 15 years).

The background traffic growth rates used to factor up the 2020 base year traffic movements illustrated in Figure 9, are in accordance with the 'Table 6.2: Link-Based Growth Rates: County Annual Growth Rates (excluding Metropolitan Area)' within the TII Publications – Project Appraisal Guidelines for National Roads Unit 5.3 – Travel Demand Projections (May 2019). These are:

- 1.071 (Central Growth) growth factor from 2020 to 2024
- 1.167 (Central Growth) growth factor from 2020 to 2029
- 1.255 (Central Growth) growth factor from 2020 to 2039

8.2 Permitted Developments in Dunshaughlin

Dunshaughlin Town has been reviewed with regards to permitted developments that have the potential to generate additional vehicle movements across the assessed local road network in addition to those previously estimated for the adjacent Phase 1 development (DA/120987) and the adjacent potential Neighbourhood Centre.

Consultation of both An Bord Pleanala (ABP) and Meath County Council (MCC) websites identified eight third party developments of various types that were approved/had their permission extended between the years of 2017 and 2020.

All these identified development sites are located to the south, east and at the town centre of Dunshaughlin and are likely to add some new vehicle movements across the assessed local road network. However, for the purpose of this traffic assessment, it was assumed that the traffic growth rates presented in Section 8.1, when applied to the baseline traffic, will already consider the increase in traffic resultant of any other permitted/potential future developments in Dunshaughlin.

The following list presents the eight afore-mentioned third party developments.

An Bord Pleanala – SHD Developments

- 1) Permitted Mixed-use Development (Reg. Ref. ABP 303433)

This mixed-use development was granted by An Bord Pleanala on 23th April 2019 under Reg. Ref. ABP 303433. The development site is located on lands to the south of Dunshaughlin Town Centre and east of R147. The permission provided for 913 No. residential units (505 No. houses, 186 No. duplexes and 222 No. apartments), a childcare facility with 1,282 sqm of area, a community facility, 2 no. retail units, a gym, a total of 1,602 no. car parking spaces and a total of 943 no. bicycle parking spaces.

2) Permitted Residential Development with Creche Facility (Reg. Ref. ABP 307244)

This residential development was granted by An Bord Pleanála on 15th September 2020 under Reg. Ref. ABP 307244. The proposed development comprises of 212 No. residential units, a creche facility, a total of 362 No. car parking spaces and a total of 264 No. cycle parking spaces on site.

Meath County Council – Permitted Developments

3) Permitted Aldi Store (Reg. Ref. FS19160)

The permitted Aldi store development with access via Dunshaughlin Main Street was granted by Meath County Council on 20th November 2019 under Reg. Ref. FS19160. The permission provided for a new single storey retail building with 1,650 sqm of area and a total of 90 No. car parking spaces on site.

4) Permitted Lidl Store (Reg. Ref. RA170866)

The permitted Lidl store development with access via Dunshaughlin Main Street was granted by Meath County Council on 18th September 2017 under Reg. Ref. RA170866. The permission provided for a two-storey building with the ground floor consisting of 2 No. retail units and a café/restaurant with a total gross floor area of c. 382.6sqm, and the first floor comprising 2 No. office units with a gross floor area of c. 300 sqm, together with a total of 163 No. car parking spaces on site.

5) Permitted Residential Development with Creche Facility (Reg. Ref. RA171239)

This permitted residential development with access via St. Seachnails was granted by Meath County Council on 28th February 2018 under Reg. Ref. RA 171239. The permission provided for the construction of 96 No. houses and a creche with 99 sqm of area.

6) Permitted Residential Development with Creche Facility (Reg. Ref. Ra171416)

This permitted residential development with access via R147 Dublin Road was granted by Meath County Council on 09th July 2018 under Reg. Ref. RA171416. The permission provided for the construction of 96 No. houses, a creche with c. 520 sqm of area and a total of 216 no. car parking spaces on site.

7) Permitted Office Development (Reg. Ref. RA191066)

This permitted office development located on Dunshaughlin Business Park was granted by Meath County Council on 04th October 2019 under Reg. Ref. RA171416. The permission provided for the extension of duration for a two-storey office block with c. 912 sqm of gross floor area, surface car parking and landscaping.

8) Permitted Residential Development (Reg. Ref. RA191066)

This permitted residential development located on Johnstown & Rath Hill to the south of Dunshaughlin Town Centre and west of R147 was approved by Meath County Council on 05th March 2020 under Reg. Ref. RA200028. The permission provided for the extension of duration for 94 No. houses and all associated site works.

9. Junction Assessment

9.1 Assessed Junctions

The junctions that have been assessed within this TTA are the following:

- **Junction 1 (Existing Signalised Crossroads):** R147 Navan Road / R125 / Drumree Road.
- **Junction 2 (Existing Priority-controlled Crossroads):** R147 Navan Road / Lagore Road.
- **Junction 3 (Existing Priority-controlled Roundabout):** R125 / L2208 / Drumree Road.
- **Junction 4 (Approved Signalised Crossroads):** Drumree Road / Access Roads to Phase 1.
- **Junction 5 (Approved Priority-controlled Roundabout):** R125 / Access Road to Phase 1.
- **Junction 6 (Proposed Priority-controlled T-junction):** L2208 / Access Road to Phase 2 North Site.
- **Junction 7 (Proposed Upgraded Roundabout):** R125 / Access Road to Phase 2 South Site.

9.2 Methodology

9.2.1 Cumulative Impact

The extent of traffic impact from the under-construction (Phase 1), proposed (Phase 2) and potential (Neighbourhood Centre) developments has been determined by initially checking where generated traffic would exceed 10% of the traffic flow on the adjoining road or 5% on the road where congestion exists, or the location is sensitive. This is in line with the NRA Transport Assessment Guidelines (2014). A summary of the existing two-way traffic and the expected traffic increase at each studied junction is presented below.

Junction	Junction Existing Flow - AM Peak Hour	Junction Existing Flow - PM Peak Hour	Additional Traffic Two-way Flow (AM)	Additional Traffic Two-way Flow (PM)	% Expected Increase (AM)	% Expected Increase (PM)
Junction 1	1,325	1,366	152	138	11.47%	10.10%
Junction 2	1,284	1,484	122	126	9.50%	8.49%
Junction 3	1,023	833	249	233	24.35%	27.97%
Junction 4	701	589	255	264	36.38%	44.82%
Junction 5	705	648	456	472	64.68%	72.84%
Junction 6	218	194	137	108	62.84%	55.67%
Junction 7	705	648	450	444	63.83%	68.52%

Table 9 | Existing and Expected Two-way Flows.

The existing flows passing through the existing Junction 7 and the approved/proposed Junctions 4, 5 and 6 have been determined by expanding the 2020 surveyed flows (Figure 9) backwards along R125, Drumree Road and L2208. This expansion of the 2020 surveyed flows is shown in Figure J in Appendix C.

As can be seen from the above, all the studied junctions are expected to receive a two-way traffic increase higher or close to 10%. Therefore, they have been modelled using ARCADY, PICADY and TRANSYT.

9.2.2 Modelling Background

There are various modelling software packages available to assess every type of junction. Waterman Moylan uses ARCADY, PICADY and TRANSYT to analyse roundabouts, priority-controlled and signalised junctions, respectively.

ARCADY is a software for modelling roundabouts. This programme utilises roundabout's geometry and traffic flows input by the user to determine Ratio of Flow to Capacity (RFC) and queue length for each link on the roundabout.

PICADY is a software for modelling priority-controlled junctions. This programme utilises junction's geometry and traffic flows input by the user to determine Ratio of Flow to Capacity (RFC) and queue length for each link on the junction.

TRANSYT (Traffic Network Study Tool) software is a widely accepted software for modelling signalised controlled junctions. This programme utilises the phases input by the user and optimises their timings over a cycle time. The outputs of a TRANSYT assessment include a Degree of Saturation percentage (DOS%) figure and queue length for each link on the road network.

Typically, a junction is said to be working satisfactorily when the DOS% or RFC of each link does not exceed 90%/0.9. Acceptable DOS% or RFC values are considered to be in the range of 80%/0.8 to 100%/1.0 with higher values indicating restrained movements.

9.3 Assessment Scenarios

The performance of the junctions has been analysed for the critical AM Peak Hour and PM Peak Hour (08:00 – 09:00 and 17:00 – 18:00) for the following scenarios:

BASE YEAR - 2020: Existing road network with 2020 Base Year flows (Figure 9). For this scenario only the surveyed Junctions 1, 2 and 3 have been modelled.

DO NOTHING - 2024: Approved junctions on the road network with 2020 baseline traffic flows factored up + traffic to/from the under-construction Phase 1 development. For this scenario only the surveyed and approved Junctions 1, 2, 3, 4 and 5 have been modelled. (Figure K – Appendix C).

DO NOTHING - 2029: Approved junctions on the road network with 2020 baseline traffic flows factored up + traffic to/from the under-construction Phase 1 development + traffic to/from the potential Neighbourhood Centre. For this scenario only the surveyed and approved Junctions 1, 2, 3, 4 and 5 have been modelled. (Figure L – Appendix C).

DO NOTHING - 2039: Approved junctions on the road network with 2020 baseline traffic flows factored up + traffic to/from the under-construction Phase 1 development + traffic to/from the potential Neighbourhood Centre. For this scenario only the surveyed and approved Junctions 1, 2, 3, 4 and 5 have been modelled. (Figure M – Appendix C).

DO SOMETHING - 2024 (Opening Year): Proposed and approved junctions on the road network with 2020 baseline traffic flows factored up + traffic to/from the under-construction Phase 1 development + traffic to/from the proposed Phase 2 development. For this scenario, all junctions have been modelled. (Figure N – Appendix C).

DO SOMETHING - 2029 (Opening Year + 5 Years): Proposed and approved junctions on the road network with 2020 baseline traffic flows factored up + traffic to/from the under-construction Phase 1 development +

traffic to/from the potential Neighbourhood Centre + traffic to/from the proposed Phase 2 development. For this scenario all junctions have been modelled. (Figure O – Appendix C).

DO SOMETHING - 2039 (Opening Year + 15 Years): Proposed and approved junctions on the road network with 2020 baseline traffic flows factored up + traffic to/from the under-construction Phase 1 development + traffic to/from the potential Neighbourhood Centre + traffic to/from the proposed Phase 2 development. For this scenario all junctions have been modelled. (Figure P – Appendix C).

9.4 Junctions Assessment Results

9.4.1 Junction 1 - R147 / R125 / Drumree Road

Junction 1 is an existing signalised crossroads located in Dunshaughlin Town Centre to the east of the proposed Phase 2 development sites. This junction has been modelled based on its current configuration and the TRANSYT analysis results are summarised below. The arms of the junction were labelled as follows within the TRANSYT model:

- Arm A: R125 (E);
- Arm B: R147 (S);
- Arm C: Drumree Road (W);
- Arm D: R147 (N).

The analysis results in Table 10 indicate that the Junction 1 is currently operating within capacity during both peak hours with the highest DOS at 70% and a corresponding queue of 7.43 vehicles recorded on Drumree Road (W) in the AM and with the highest DOS at 73% and a corresponding queue of 10.09 vehicles recorded on R125 (E) in the PM.

BASE YEAR - 2020					
Arm	Movement	AM		PM	
		DOS%	Queue (Veh)	DOS%	Queue (Veh)
A	S/L	68	7.87	73	10.09
	R	22	1.89	34	2.85
B	S/L	23	3.48	58	9.66
	R	37	1.17	57	3.08
C	S/L	44	4.61	28	3.13
	R	70	7.43	69	6.62
D	S/L	66	12.93	39	5.95
	R	34	1.08	19	0.88

Table 10 | Junction 1 – 2020 BASE YEAR – TRANSYT Analysis Results.

For the future assessment year of 2024 DO NOTHING, with the baseline flows factored up and the inclusion of the trips estimated for the under-construction Phase 1 development, as presented in Table 11, Junction 1 would continue to operate within capacity during both peak hours with the highest DOS at 74% and a corresponding queue of 14.89 vehicles recorded on R147 (N) in the AM and with the highest DOS at 78% and a corresponding queue of 7.98 vehicles recorded on Drumree Road (W) in the PM.

For the opening year of 2024 DO SOMETHING, with the baseline flows factored up and the inclusion of the trips generated by the under-construction Phase 1 and proposed Phase 2 developments, as presented

in Table 11, Junction 1 will continue to operate within capacity during both peak hours, with the highest DOS at 78% and a corresponding queue of 15.57 vehicles recorded on R147 (N) in the AM and with the highest DOS at 79% and a corresponding queue 12.02 vehicles recorded on R125 (E) in the PM.

DO NOTHING - 2024					
Arm	Movement	AM		PM	
		DOS%	Queue (Veh)	DOS%	Queue (Veh)
A	S/L	74	9.06	77	11.38
	R	21	1.99	37	3.08
B	S/L	25	3.87	63	10.77
	R	39	1.25	61	3.36
C	S/L	51	5.49	30	3.49
	R	74	8.67	78	7.98
D	S/L	74	14.89	43	6.56
	R	38	1.21	21	0.98
DO SOMETHING – 2024 (Opening Year)					
Arm	Movement	AM		PM	
		DOS%	Queue (Veh)	DOS%	Queue (Veh)
A	S/L	78	9.70	79	12.02
	R	19	1.95	35	3.04
B	S/L	27	3.97	67	11.19
	R	39	1.25	61	3.36
C	S/L	58	6.45	31	3.80
	R	78	10.14	79	8.63
D	S/L	78	15.57	45	6.79
	R	38	1.21	21	0.98

Table 11 | Junction 1 – 2024 DO NOTHING and DO SOMETHING – TRANSYT Analysis Results.

For the future assessment year of 2039 DO NOTHING, with the baseline flows factored up and the inclusion of the trips estimated for the under-construction Phase 1 development and the potential Neighbourhood Centre, as presented in Table 12, Junction 1 would continue to operate within capacity during both peak hours with the highest DOS at 89% and a corresponding queue of 20.92 vehicles recorded on R147 (N) in the AM and with the highest DOS at 93% and a corresponding queue of 17.41 vehicles recorded on R125 (E) in the PM.

For the future assessment year of 2039 DO SOMETHING, with the flows factored up and the inclusion of the trips estimated for the under-construction Phase 1 development, the potential Neighbourhood Centre and the proposed Phase 2 development, as presented in Table 12, Junction 1 will continue to operate within capacity during both peak hours, with the highest DOS at 96% and a corresponding queue of 16.43 vehicles recorded on Drumree Road (W) in the AM and with the highest DOS at 94% and a corresponding queue of 18.35 vehicles recorded on R125 (E) in the PM.

DO NOTHING - 2039					
Arm	Movement	AM		PM	
		DOS%	Queue (Veh)	DOS%	Queue (Veh)
A	S/L	88	12.99	93	17.41
	R	25	2.36	37	3.52
B	S/L	30	4.71	81	14.69
	R	46	1.51	71	4.28
C	S/L	59	6.78	40	4.85
	R	89	12.44	89	12.13
D	S/L	89	20.92	54	8.35
	R	48	1.60	25	1.19
DO SOMETHING – 2039 (Opening Year + 15 Years)					
Arm	Movement	AM		PM	
		DOS%	Queue (Veh)	DOS%	Queue (Veh)
A	S/L	91	14.43	94	18.35
	R	24	2.34	35	3.48
B	S/L	31	4.76	86	15.66
	R	46	1.51	71	4.28
C	S/L	66	7.86	41	5.09
	R	96	16.43	90	12.89
D	S/L	91	21.87	58	8.57
	R	48	1.60	25	1.19

Table 12 | Junction 1 – 2039 DO NOTHING and DO SOMETHING – TRANSYT Analysis Results.

Full assessment of Junction 1, including 2029 DO NOTHING and DO SOMETHING scenarios, has been provided in Appendix E.

9.4.2 Junction 2 - R147 / Lagore Road

Junction 2 is an existing priority-controlled crossroads located in Dunshaughlin Town Centre to the east of the proposed Phase 2 development sites. This junction has been modelled based on its current configuration and the PICADY analysis results are summarised below. The arms of the junction were labelled as follows within the PICADY model:

- Arm A: R147 (S);
- Arm B: Minor Arm (W);
- Arm C: R147 (N);
- Arm D: Lagore Road (E).

The analysis results in Table 13 indicate that the Junction 2 is currently operating within capacity during both peak hours with the highest RFC at 0.41 and a corresponding queue of 0.7 vehicle recorded on Lagore Road (E) in the AM and with the highest RFC at 0.43 and a corresponding queue of 0.7 vehicle recorded on the western minor arm in the PM.

BASE YEAR - 2020				
Stream	AM		PM	
	RFC	Queue (Veh)	RFC	Queue (Veh)
B-ACD	0.12	0.1	0.43	0.7
A-D	0.17	0.2	0.24	0.3
D-ABC	0.41	0.7	0.35	0.5
C-ABD	0.10	0.2	0.23	0.5

Table 13 | Junction 2 – 2020 BASE YEAR – PICADY Analysis Results.

For the future assessment year of 2024 DO NOTHING, with the baseline flows factored up and the inclusion of the trips estimated for the under-construction Phase 1 development, as presented in Table 14, Junction 2 would continue to operate within capacity during both peak hours with the highest RFC at 0.46 and a corresponding queue of 0.8 vehicle recorded on Lagore Road (E) in the AM and with the highest RFC at 0.48 and a corresponding queue of 0.9 vehicle recorded on the western minor arm in the PM.

For the opening year of 2024 DO SOMETHING, with the baseline flows factored up and the inclusion of the trips generated by the under-construction Phase 1 and proposed Phase 2 developments, as presented in Table 14, Junction 2 will continue to operate within capacity during both peak hours, with the highest RFC at 0.47 and a corresponding queue of 0.9 vehicle recorded on Lagore Road (E) in the AM and with the highest RFC at 0.50 and a corresponding queue 1.0 vehicle recorded on the western minor arm in the PM.

DO NOTHING - 2024				
Stream	AM		PM	
	RFC	Queue (Veh)	RFC	Queue (Veh)
B-ACD	0.14	0.2	0.48	0.9
A-D	0.18	0.2	0.26	0.3
D-ABC	0.46	0.8	0.39	0.6
C-ABD	0.12	0.3	0.27	0.7
DO SOMETHING – 2024 (Opening Year)				
Stream	AM		PM	
	RFC	Queue (Veh)	RFC	Queue (Veh)
B-ACD	0.14	0.2	0.50	1.0
A-D	0.19	0.2	0.26	0.3
D-ABC	0.47	0.9	0.40	0.7
C-ABD	0.13	0.3	0.27	0.7

Table 14 | Junction 2 – 2024 DO NOTHING and DO SOMETHING – PICADY Analysis Results.

For the future assessment year of 2039 DO NOTHING, with the baseline flows factored up and the inclusion of the trips estimated for the under-construction Phase 1 development and the potential Neighbourhood Centre, as presented in Table 15, Junction 2 would continue to operate within capacity during both peak hours with the highest RFC at 0.59 and a corresponding queue of 1.4 vehicle recorded on Lagore Road (E) in the AM and with the highest RFC at 0.68 and a corresponding queue of 2.1 vehicles recorded on the western minor arm in the PM.

For the future assessment year of 2039 DO SOMETHING, with the baseline flows factored up and the inclusion of the trips estimated for the under-construction Phase 1 development, the potential Neighbourhood Centre and the proposed Phase 2 development, as presented in Table 15, Junction 2 will continue to operate within capacity during both peak hours, with the highest RFC at 0.61 and a corresponding queue of 1.5 vehicle recorded on Lagore Road (E) in the AM and with the highest RFC at 0.70 and a corresponding queue of 2.3 vehicles recorded on the western minor arm in the PM.

DO NOTHING - 2039				
Stream	AM		PM	
	RFC	Queue (Veh)	RFC	Queue (Veh)
B-ACD	0.18	0.2	0.68	2.1
A-D	0.23	0.3	0.32	0.5
D-ABC	0.59	1.4	0.52	1.1
C-ABD	0.16	0.5	0.37	1.2
DO SOMETHING – 2039 (Opening Year + 15 Years)				
Stream	AM		PM	
	RFC	Queue (Veh)	RFC	Queue (Veh)
B-ACD	0.19	0.2	0.70	2.3
A-D	0.23	0.3	0.32	0.5
D-ABC	0.61	1.5	0.53	1.1
C-ABD	0.17	0.5	0.38	1.3

Table 15 | Junction 2 – 2024 and 2039 DO SOMETHING – PICADY Analysis Results.

Full assessment of Junction 2, including 2029 DO NOTHING and DO SOMETHING scenarios, has been provided in Appendix E.

9.4.3 Junction 3 - R125 / L2208 / Drumree Road

Junction 3 is an existing four-armed roundabout located southeast of the proposed North Site of Phase 2. This roundabout has been modelled based on its current configuration and the ARCADY analysis results are summarised below. The arms of the roundabout were labelled as follows within the ARCADY model:

- Arm 1: Drumree Road (E);
- Arm 2: R125 (S);
- Arm 3: L2208 (W);
- Arm 4: R125 (N).

The analysis results in Table 16 indicate that the Junction 3 is currently operating within capacity during both peak hours with the highest RFC at 0.29 and a corresponding queue of 0.4 vehicle recorded on Drumree Road (E) in the AM and with the highest RFC at 0.27 and a corresponding queue of 0.4 vehicle also recorded on Drumree Road (E) in the PM.

BASE YEAR - 2020				
Arm	AM		PM	
	RFC	Queue (Veh)	RFC	Queue (Veh)
Arm 1	0.29	0.4	0.27	0.4
Arm 2	0.25	0.3	0.25	0.3
Arm 3	0.13	0.2	0.05	0.1
Arm 4	0.14	0.2	0.06	0.1

Table 16 | Junction 3 – 2020 BASE YEAR – ARCADY Analysis Results.

For the future assessment year of 2024 DO NOTHING, with the baseline flows factored up and the inclusion of the trips estimated for the under-construction Phase 1 development, as presented in Table 17, Junction 3 would continue to operate within capacity during both peak hours with the highest RFC at 0.33 and a corresponding queue of 0.5 vehicle recorded on Drumree Road (E) in the AM and with the highest RFC at 0.30 and a corresponding queue of 0.4 vehicle also recorded on Drumree Road (E) in the PM.

For the opening year of 2024 DO SOMETHING, with the baseline flows factored up and the inclusion of the trips generated by the under-construction Phase 1 and proposed Phase 2 developments, as presented in Table 17, Junction 3 will continue to operate within capacity during both peak hours, with the highest RFC at 0.36 and a corresponding queue of 0.6 vehicle recorded on Drumree Road (E) in the AM and with the highest RFC at 0.33 and a corresponding queue 0.5 vehicle also recorded on Drumree Road (E) in the PM.

DO NOTHING - 2024				
Arm	AM		PM	
	RFC	Queue (Veh)	RFC	Queue (Veh)
Arm 1	0.33	0.5	0.30	0.4
Arm 2	0.28	0.4	0.29	0.4
Arm 3	0.15	0.2	0.06	0.1
Arm 4	0.15	0.2	0.07	0.1

DO SOMETHING – 2024 (Opening Year)				
Arm	AM		PM	
	RFC	Queue (Veh)	RFC	Queue (Veh)
Arm 1	0.36	0.6	0.33	0.5
Arm 2	0.32	0.5	0.32	0.5
Arm 3	0.23	0.3	0.09	0.1
Arm 4	0.16	0.2	0.08	0.1

Table 17 | Junction 3 – 2024 DO NOTHING and DO SOMETHING – ARCADY Analysis Results.

For the future assessment year of 2039 DO NOTHING, with the baseline flows factored up and the inclusion of the trips estimated for the under-construction Phase 1 development and the potential Neighbourhood Centre, as presented in Table 18, Junction 3 would continue to operate within capacity during both peak hours with the highest RFC at 0.41 and a corresponding queue of 0.7 vehicle recorded on Drumree Road (E) in the AM and with the highest RFC at 0.37 and a corresponding queue of 0.6 vehicle also recorded on Drumree Road (E) in the PM.

For the future assessment year of 2039 DO SOMETHING, with the baseline flows factored up and the inclusion of the trips estimated for the under-construction Phase 1 development, the potential Neighbourhood Centre and the proposed Phase 2 development, as presented in Table 18, Junction 3 will continue to operate within capacity during both peak hours, with the highest RFC at 0.44 and a corresponding queue of 0.8 vehicle recorded on Drumree Road (E) in the AM and with the highest RFC at 0.40 and a corresponding queue of 0.7 vehicle also recorded on Drumree Road (E) in the PM.

DO NOTHING - 2039				
Arm	AM		PM	
	RFC	Queue (Veh)	RFC	Queue (Veh)
Arm 1	0.41	0.7	0.37	0.6
Arm 2	0.34	0.5	0.36	0.6
Arm 3	0.19	0.2	0.08	0.1
Arm 4	0.19	0.2	0.09	0.1
DO SOMETHING – 2039 (Opening Year + 15 Years)				
Arm	AM		PM	
	RFC	Queue (Veh)	RFC	Queue (Veh)
Arm 1	0.44	0.8	0.40	0.7
Arm 2	0.37	0.6	0.39	0.7
Arm 3	0.28	0.4	0.11	0.1
Arm 4	0.20	0.3	0.10	0.1

Table 18 | Junction 3 – 2039 DO NOTHING and DO SOMETHING – ARCADY Analysis Results.

Full assessment of Junction 3, including 2029 DO NOTHING and DO SOMETHING scenarios, has been provided in Appendix E.

9.4.4 Junction 4 – Drumree Road / Access Roads to Phase 1

Junction 4 is an approved (under-construction) signalised junction located on Drumree Road to the north of the proposed Phase 2 South Site. This junction has been modelled based on its approved configuration and the TRANSYT analysis results are summarised below. The arms of the junction were labelled as follows within the TRANSYT model:

- Arm A: Drumree Road (E);
- Arm B: Phase 1 Site Access Road (S);
- Arm C: Drumree Road (W);
- Arm D: Phase 1 Site Access Road (N).

The analysis results in Table 19 indicate that, for the future assessment of 2024 DO NOTHING, with the baseline flows factored up and the inclusion of the trips estimated for the under-construction Phase 1 development, Junction 4 would operate within capacity during both peak hours with the highest DOS at 63% and a corresponding queue of 11.38 vehicles recorded on Drumree Road (E) in the AM and with the highest DOS at 54% and a corresponding queue of 8.57 vehicles recorded on Drumree Road (W) in the PM.

For the opening year of 2024 DO SOMETHING, with the baseline flows factored up and the inclusion of the trips generated by the under-construction Phase 1 and proposed Phase 2 developments, as presented in Table 19, Junction 4 will continue to operate within capacity during both peak hours, with the highest DOS at 73% and a corresponding queue of 13.50 vehicles recorded on Drumree Road (W) in the AM and with the highest DOS at 60% and a corresponding queue 9.46 vehicles also recorded on Drumree Road (W) in the PM.

DO NOTHING - 2024					
Arm	Movement	AM		PM	
		DOS%	Queue (Veh)	DOS%	Queue (Veh)
A	S/L/R	63	11.38	51	9.62
B	S/L/R	11	0.32	20	0.22
C	S/L	63	11.31	54	8.57
	R	0	0.00	0	0.00
D	S/L/R	36	1.13	23	0.71
DO SOMETHING – 2024 (Opening Year)					
Arm	Movement	AM		PM	
		DOS%	Queue (Veh)	DOS%	Queue (Veh)
A	S/L/R	65	12.30	56	11.03
B	S/L/R	48	1.60	29	0.77
C	S/L	73	13.50	60	9.46
	R	1	0.14	2	0.19
D	S/L/R	36	1.13	35	0.77

Table 19 | Junction 4 – 2024 DO NOTHING and DO SOMETHING – TRANSYT Analysis Results.

For the future assessment year of 2039 DO NOTHING, with the baseline flows factored up and the inclusion of the trips estimated for the under-construction Phase 1 development and the potential Neighbourhood Centre, as presented in Table 20, Junction 4 would continue to operate within capacity during both peak hours with the highest DOS at 78% and a corresponding queue of 16.20 vehicles recorded on Drumree Road (E) in the AM and with the highest DOS at 70% and a corresponding queue of 11.56 vehicles recorded on Drumree Road (W) in the PM.

For the future assessment year of 2039 DO SOMETHING, with the addition of the trips estimated for the under-construction Phase 1 development, the potential Neighbourhood Centre and the proposed Phase 2 development, as presented in Table 20, Junction 4 will continue to operate within capacity during both peak hours, with the highest DOS at 85% and a corresponding queue of 17.57 vehicles recorded on Drumree Road (W) in the AM and with the highest DOS at 75% and a corresponding queue of 12.61 vehicles also recorded on Drumree Road (W) in the PM.

DO NOTHING – 2039					
Arm	Movement	AM		PM	
		DOS%	Queue (Veh)	DOS%	Queue (Veh)
A	S/L/R	78	16.20	66	13.50
B	S/L/R	29	0.89	51	2.00
C	S/L	78	15.15	70	11.56
	R	2	0.23	2	0.19
D	S/L/R	36	1.13	35	0.77
DO SOMETHING – 2039 (Opening Year + 15 Years)					
Arm	Movement	AM		PM	
		DOS%	Queue (Veh)	DOS%	Queue (Veh)
A	S/L/R	83	18.12	72	15.48
B	S/L/R	64	2.43	52	2.51
C	S/L	85	17.57	75	12.61
	R	2	0.32	3	0.33
D	S/L/R	36	1.13	47	0.88

Table 20 | Junction 4 – 2039 DO NOTHING and DO SOMETHING – TRANSYT Analysis Results.

Full assessment of Junction 4, including 2029 DO NOTHING and DO SOMETHING scenarios, has been provided in Appendix E.

9.4.5 Junction 5 - R125 / Access Road to Phase 1

Junction 5 is an approved four-armed roundabout to be located immediately northwest of the proposed South Site of Phase 2. This roundabout has been modelled based on its approved configuration and the ARCADY analysis results are summarised below. The arms of the roundabout were labelled as follows within the ARCADY model:

- Arm 1: Phase 1 Site Access Road (E);
- Arm 2: R125 (S);
- Arm 3: Minor Access Road (W);
- Arm 4: R125 (N).

The analysis results in Table 21 indicate that, for the future assessment year of 2024 DO NOTHING, with the baseline flows factored up and the inclusion of the trips estimated for the under-construction Phase 1 development, Junction 5 would operate within capacity during both peak hours with the highest RFC at 0.22 and a corresponding queue of 0.3 vehicle recorded on R125 (N and S) in the AM and with the highest RFC at 0.24 and a corresponding queue of 0.3 vehicle also recorded on R125 (S) in the PM.

For the opening year of 2024 DO SOMETHING, with the baseline flows factored up and the inclusion of the trips generated by the under-construction Phase 1 and proposed Phase 2 developments, as presented in Table 21, Junction 5 will continue to operate within capacity during both peak hours, with the highest RFC at 0.27 and a corresponding queue of 0.4 vehicle recorded on R125 (N) in the AM and with the highest RFC at 0.29 and a corresponding queue 0.4 vehicle recorded on R125 (S) in the PM.

DO NOTHING - 2024				
Arm	AM		PM	
	RFC	Queue (Veh)	RFC	Queue (Veh)
Arm 1	0.02	0.0	0.01	0.0
Arm 2	0.22	0.3	0.24	0.3
Arm 3	0.00	0.0	0.00	0.0
Arm 4	0.22	0.3	0.18	0.2
DO SOMETHING - 2024 (Opening Year)				
Arm	AM		PM	
	RFC	Queue (Veh)	RFC	Queue (Veh)
Arm 1	0.08	0.1	0.04	0.0
Arm 2	0.26	0.4	0.29	0.4
Arm 3	0.00	0.0	0.00	0.0
Arm 4	0.27	0.4	0.21	0.3

Table 21 | Junction 5 – 2024 DO NOTHING and DO SOMETHING – ARCADY Analysis Results.

For the future assessment year of 2039 DO NOTHING, with the baseline flows factored up and the inclusion of the trips estimated for the under-construction Phase 1 development and the potential Neighbourhood Centre, as presented in Table 22, Junction 5 would continue to operate within capacity during both peak hours with the highest RFC at 0.31 and a corresponding queue of 0.5 vehicle recorded on R125 (S) in the AM and with the highest RFC at 0.31 and a corresponding queue of 0.5 vehicle also recorded on R125 (S) in the PM.

For the future assessment year of 2039 DO SOMETHING, with the inclusion of the trips estimated for the under-construction Phase 1 development, the potential Neighbourhood Centre and the proposed Phase 2 development, as presented in Table 22, Junction 5 will continue to operate within capacity during both peak hours, with the highest RFC at 0.35 and a corresponding queue of 0.5 vehicle recorded on R125 (S) in the AM and with the highest RFC at 0.36 and a corresponding queue of 0.6 vehicle also recorded on R125 (S) in the PM.

DO NOTHING - 2039				
Arm	AM		PM	
	RFC	Queue (Veh)	RFC	Queue (Veh)
Arm 1	0.06	0.1	0.12	0.1
Arm 2	0.31	0.5	0.31	0.5
Arm 3	0.00	0.0	0.00	0.0
Arm 4	0.28	0.4	0.23	0.3
DO SOMETHING – 2039 (Opening Year + 15 Years)				
Arm	AM		PM	
	RFC	Queue (Veh)	RFC	Queue (Veh)
Arm 1	0.12	0.1	0.14	0.2
Arm 2	0.35	0.5	0.36	0.6
Arm 3	0.00	0.0	0.00	0.0
Arm 4	0.33	0.5	0.26	0.3

Table 22 | Junction 5 – 2039 DO NOTHING and DO SOMETHING – ARCADY Analysis Results.

Full assessment of Junction 5, including 2029 DO NOTHING and DO SOMETHING scenarios, has been provided in Appendix E.

9.4.6 Junction 6 – L2208 / Access Road to Phase 2 North Site

Junction 6 is a priority-controlled T-junction proposed to provide access to the subject North Site of Phase 2. This junction has been modelled based on its proposed configuration and the PICADY analysis results are summarised below. The arms of the junction were labelled as follows within the PICADY model:

- Arm A: L2208 (W);
- Arm B: Phase 2 North Site Access Road (N);
- Arm C: L2208 (E).

For the opening year of 2024 DO SOMETHING, with the baseline flows factored up and the inclusion of the trips generated by the under-construction Phase 1 and proposed Phase 2 developments, as presented in Table 23, Junction 6 will operate within capacity during both peak hours, with the highest RFC at 0.15 and a corresponding queue of 0.2 vehicle recorded on Phase 2 North Site Access Road (N) in the AM and with the highest RFC at 0.10 and a corresponding queue 0.1 vehicle recorded on L2208 (E) in the PM.

For the future assessment year of 2039 DO SOMETHING, with the inclusion of the trips estimated for the under-construction Phase 1 development, the potential Neighbourhood Centre and the proposed Phase 2 development, as presented in Table 23, Junction 6 will continue to operate within capacity during both peak hours, with the highest RFC at 0.15 and a corresponding queue of 0.2 vehicle recorded on Phase 2 North Site Access Road (N) in the AM and with the highest RFC at 0.10 and a corresponding queue of 0.2 vehicle recorded on L2208 (E) in the PM.

DO SOMETHING - 2024 (Opening Year)				
Stream	AM		PM	
	RFC	Queue (Veh)	RFC	Queue (Veh)
B-AC	0.15	0.2	0.05	0.1
C-AB	0.06	0.1	0.10	0.1
DO SOMETHING – 2039 (Opening Year + 15 Years)				
Stream	AM		PM	
	RFC	Queue (Veh)	RFC	Queue (Veh)
B-AC	0.15	0.2	0.05	0.1
C-AB	0.07	0.1	0.10	0.2

Table 23 | Junction 6 – 2024 and 2039 DO SOMETHING – PICADY Analysis Results.

Full assessment of Junction 6, including 2029 DO SOMETHING scenario, has been provided in Appendix E.

9.4.7 Junction 7 - R125 / Access Road to Phase 2 South Site

Junction 7 is an existing two-armed roundabout located immediately southwest of the proposed Phase 2 South Site, which is proposed to be upgraded to a three-armed roundabout with the eastern arm forming the Site Access Road to the Phase 2 South Site. This roundabout has been modelled based on its proposed

configuration (three-armed roundabout) and the ARCADY analysis results are summarised below. The arms of the roundabout were labelled as follows within the ARCADY model:

- Arm 1: Phase 2 South Site Access Road (E);
- Arm 2: R125 (W);
- Arm 3: R125 (N).

For the opening year of 2024 DO SOMETHING, with the baseline flows factored up and the inclusion of the trips generated by the under-construction Phase 1 and proposed Phase 2 developments, as presented in Table 24, Junction 7 will continue to operate within capacity during both peak hours, with the highest RFC at 0.37 and a corresponding queue of 0.6 vehicle recorded on R125 (N) in the AM and with the highest RFC at 0.34 and a corresponding queue 0.5 vehicle recorded on R125 (W) in the PM.

For the future assessment year of 2039 DO SOMETHING, with the inclusion of the trips estimated for the under-construction Phase 1 development, the potential Neighbourhood Centre and the proposed Phase 2 development, as presented in Table 24, Junction 7 will continue to operate within capacity during both peak hours, with the highest RFC at 0.44 and a corresponding queue of 0.8 vehicle recorded on R125 (N) in the AM and with the highest RFC at 0.43 and a corresponding queue of 0.7 vehicle also recorded on R125 (W) in the PM.

DO SOMETHING - 2024 (Opening Year)				
Arm	AM		PM	
	RFC	Queue (Veh)	RFC	Queue (Veh)
Arm 1	0.04	0.0	0.02	0.0
Arm 2	0.30	0.4	0.34	0.5
Arm 3	0.37	0.6	0.27	0.4
DO SOMETHING – 2039 (Opening Year + 15 Years)				
Arm	AM		PM	
	RFC	Queue (Veh)	RFC	Queue (Veh)
Arm 1	0.04	0.0	0.02	0.0
Arm 2	0.41	0.7	0.43	0.7
Arm 3	0.44	0.8	0.38	0.6

Table 24 | Junction 7 – 2024 and 2039 DO SOMETHING – ARCADY Analysis Results.

Full assessment of Junction 7, including 2029 DO SOMETHING scenario, has been provided in Appendix E.

10. Construction Traffic

When considering a development of this nature, the potential traffic impact on the surrounding area must also be considered for the construction phase.

During the construction phase of the proposed development, some construction traffic movements will be undertaken by heavy good vehicles and by vehicles associated with the appointed contractors and their staff.

It is proposed that the development will be constructed in three phases. It is estimated that the duration of construction works will last 24 to 36 months depending on the sales velocities. During the initial periods of each phase it is estimated that typically 50 to 60 staff will be on site per day and during the peak construction periods it would fluctuate up to 150 to 200 staff and contractors on site per day in total, which with an allowance for shared journeys could be equate to a maximum of around 100 number vehicles during the peak construction periods. Public transport routes exist in the vicinity of the subject site, which would also be an option for construction workers to access the subject site.

As can be seen above, the number of construction vehicle movements will be significantly low compared to the number of vehicular trips to be generated by the proposed development during the operational phase. Typical working hours for the site will be 07:00 to 18:00 Monday to Friday and 08:00 to 14:00 Saturday. It should be noted that the majority of such construction vehicle movements would be undertaken outside of the traditional AM and PM peak hours. Therefore, it is not considered that this level of construction traffic would result in any operational problem. In this regard, no junction assessment for the construction phase was undertaken.

No parking of construction related vehicles will be permitted on the adjoining road network and adequate parking facilities will be made available within the Construction Compound for all site workers during construction.

Care will be taken to ensure existing pedestrian and cycling routes are suitably maintained or appropriately diverted as necessary during the construction period. It is likely that construction will have a negligible impact on pedestrian and cycle infrastructure.

All construction traffic will be managed strictly according to the proposed Construction Management Plan.

11. Servicing

11.1 Waste Collection

The proposed Phase 2 development, both North and South Sites, will be accessible for refuse vehicles/fire tenders. Turning path layout for refuse vehicle and fire tender are shown on Waterman Moylan Drg No's 12-081A-P140A, 12-081A-P141A and 12-081A-P142A accompanying the documentation package.

12. Car Parking

12.1 Meath County Development Plan 2013 – 2019 – Standards and Requirements

Standards for car parking in new developments are set out in Section 11.9 of the Meath County Development Plan 2013 – 2019 (MCDP). Based on the MCDP standards, Table 25 and Table 26 below set out the parking requirements applicable to the proposed Phase 2 North and South Sites, respectively.

12.1.1 Phase 2 - North Site

The proposed Phase 2 North Site will consist of 95 No. Houses, 20 No. Duplexes and 34 No. Apartments. The car parking requirement for the proposed North Site as per MCDP is shown in Table 25 below.

There are no car parking standards set out for duplexes within Meath County Development Plan. Therefore, for the purpose of calculation, the car parking standard for flats/apartments has been applied for the duplex units.

Land Use	No. Units	MCDP Standards	MCDP Requirements
Dwellings (Houses)	95 No. units	2 spaces per dwelling	190 spaces
Apartments/ Duplexes	11 No. 1-bed units 32 No. 2-bed units 11 No. 3-bed units	1.25 space per 1 & 2-bed units 2 spaces per 3-bed units + 1 visitor space per 4 apartments	54 spaces + 22 spaces + 14 visitor spaces
Total	149 units	266 spaces for residents + 14 spaces for visitors	

Table 25 | Phase 2 North Site – Car Parking Spaces Required – MCDP 2013 – 2019.

In reference to the MCDP Standards and the proposed schedule of accommodation, MCDP requires the provision of 280 car parking spaces to serve the subject North Site of Phase 2, 266 for residents and 14 for visitors.

12.1.2 Phase 2 - South Site

The proposed South Site will consist of 159 No. Houses, 35 No. Duplexes, 72 No. Apartments and a Creche with capacity to accommodate 80 children and 16 staff. The car parking requirement for the proposed South Site as per MDCP is shown in Table 26 below.

As per the North Site calculation, due to the lack of car parking standards for duplexes within MCDP, the car parking standard for flats/apartments has been applied for this type of use.

Land Use	No. Units / Capacity	MCDP Standards	MCDP Requirements
Dwellings (Houses)	159 No. units	2 spaces per dwelling	318 spaces
Apartments/ Duplexes	21 No. 1-bed units 66 No. 2-bed units 20 No. 3-bed units	1.25 space per 1 & 2-bed units 2 spaces per 3-bed units + 1 visitor space per 4 apartments	109 spaces + 40 spaces + 27 visitor spaces
Creche	16 staff and 80 children	1 space per employee + 1 set down area per 5 children	16 spaces + 16 set down
Total	149 units 16 staff and 80 children	467 spaces for residents + 27 spaces for visitors + 16 spaces for creche staff + 16 set down spaces	

Table 26 | Phase 2 South Site – Car Parking Spaces Required – MCDP 2013 – 2019.

As can be seen from the above, MCDP requires the provision of 526 car parking spaces to serve the subject South Site development of Phase 2, 467 for residents, 27 for visitors and 32 for the proposed Creche.

12.2 Design Standards for New Apartments – March 2018

In March 2018, a revised version of the document “Sustainable Urban Housing: Design Standard for New Apartments” was released. The parking standards set out in this document are considerably lower than those contained in the Meath County Development Plan 2013 – 2019 in respect to apartment developments.

Based on the “Sustainable Urban Housing: Design Standard for New Apartments” criteria, the proposed Phase 2 development is considered to be in the ‘**Peripheral and/or Less Accessible Urban Locations**’ category based on the following facts:

1. The proposed Phase 2 development sites are located in a moderate size town of Dunshaughlin, Co. Meath.
2. Bus stops are located on the Main Street in Dunshaughlin town centre, which is c. 12-minute walking distance from the subject sites.
3. Bus Eireann bus services 109, 109A and 109B serves Dunshaughlin town with a service frequency to Dublin at 10-20 minutes during peak hours.
4. M3 Parkway Park and Ride Railway Station is located approximately 12.5km from the subject sites and can be reached by car in 10 minutes. The trains between M3 Parkway and Dublin Pearse operates at a frequency of 3 - 4 services per hour on weekdays.

The following extracts from the “Design Standards for New Apartments – March 2018” summarises the guidelines for parking in new apartment developments situated in a Peripheral and/or Less Accessible Urban Location.

“Peripheral and/or Less Accessible Urban Locations: As a benchmark guideline for apartments in relatively peripheral or less accessible urban locations, one car parking space per unit, together with an element of visitor parking, such as one space for every 3-4 apartments, should be generally be required.”

12.3 Car Parking Proposed

The number of car parking spaces projected to serve the proposed North and South Sites of Phase 2 development are presented below. The development’s car parking proposals include the provision of a total 664 No. car parking spaces which will all be provided on surface within the development.

Allocation of the proposed parking spaces for the overall Phase 2 development is outlined below:

- **Residential (254 Houses):** 442 No. car parking spaces, which equates to a ratio of approximately 1.7 car parking spaces per house unit.
- **Residential (161 Apartments & Duplexes):** 161 No. car parking spaces, which equates to a ratio of 1.0 car parking space per apartment/duplex unit.
- **Residential (Visitor):** 47 No. car parking spaces.
- **Disable Parking:** 6 No. car parking spaces.
- **Creche:** 8 No. car parking spaces (Staff parking).

13. Bicycle Parking

13.1 Meath County Development Plan 2013 – 2019 – Standards

Standards for bicycle parking in new developments are set out in Section 11.9.2 of the Meath County Development Plan 2013 – 2019, which states that:

*“Secure cycle parking facilities shall be provided in new office, residential, retail and employment generating developments. Bicycle racks shall be provided in all cases where Meath County Council deems bicycle parking necessary. Such facilities should be within 25 metres of a destination for short-term parking, (shops) and 50 metres for long term parking (school, college and office). **The number of stands required will be a third of the number of car spaces required for the development, subject to a minimum of one stand.**”*

13.1.1 Phase 2 - North Site

Based on the car parking calculation shown in Table 25 and applying the standard of 1 bicycle parking space per 3 car parking spaces as set out in the Meath County Development Plan 2013 – 2019, as per Table 27 below, the proposed North Site of Phase 2 is required to provide at least 93 bicycle parking stands.

Land Use	MCDP Car Parking Required	MCDP Bicycle Parking Standard	MCDP Bicycle Parking Required
Dwellings (Houses)	190 car spaces	1 bicycle parking space per 3 car parking spaces	63 bicycle parking spaces
Apartments/ Duplexes	54 car spaces + 22 car spaces + 14 visitor car spaces	1 bicycle parking space per 3 car parking spaces	18 bicycle parking spaces + 7 bicycle parking spaces + 5 visitor bicycle parking spaces
Total	280 car parking spaces		88 bicycle parking spaces for residents + 5 bicycle parking spaces for visitors

Table 27 | Phase 2 North Site – Bicycle Parking Spaces Required – MCDP 2013 – 2019.

13.1.2 Phase 2 - South Site

Based on the car parking calculation shown in Table 26 and applying the standard of 1 bicycle parking space per 3 car parking spaces as set out in the MCDP, as per Table 28 below, the proposed South Site of Phase 2 is required to provide at least 174 bicycle parking stands.

Land Use	MCDP Car Parking Required	MCDP Bicycle Parking Standard	MCDP Bicycle Parking Required
Dwellings (Houses)	318 car spaces	1 bicycle parking space per 3 car parking spaces	106 bicycle parking spaces
Apartments/ Duplexes	109 car spaces + 40 car spaces + 27 visitor car spaces	1 bicycle parking space per 3 car parking spaces	36 bicycle parking spaces + 13 bicycle parking spaces + 9 visitor bicycle parking spaces
Creche	16 car spaces + 16 set down	1 bicycle parking space per 3 car parking spaces	5 bicycle parking spaces + 5 bicycle parking spaces
Total	526 car parking spaces	155 bicycle parking spaces for residents + 9 bicycle parking spaces for visitors + 10 bicycle parking spaces for the Creche	

Table 28 | Phase 2 South Site – Bicycle Parking Spaces Required – MCDP 2013 – 2019.

13.2 Design Standard for New Apartments, March 2018

Section 4.17 of the “Design Standards for New Apartments – March 2018” (DSNA) sets out a minimum standard of cycle storage space for new apartment developments as follows:

“A general minimum standard of 1 cycle storage space per bedroom shall be applied. For studio units, at least 1 cycle storage space shall be provided. Visitor cycle parking shall also be provided at a standard of 1 space per 2 residential units.”

Based on that, Table 29 below sets out the parking requirements applicable to the apartment elements of the proposed North and South Sites of Phase 2.

Phase 2	Apartment + Duplex Units	DSNA Standard	MCDP Bicycle Parking Required
North Site	11 No. 1-bed units 32 No. 2-bed units 11 No. 3-bed units	1 bicycle parking space per bedroom + 1 visitor bicycle parking space per 2 residential units	11 bicycle parking spaces + 64 bicycle parking spaces + 33 bicycle parking spaces + 27 visitor bicycle parking spaces
South Site	21 No. 1-bed units 66 No. 2-bed units 20 No. 3-bed units		21 bicycle parking spaces + 132 bicycle parking spaces + 60 bicycle parking spaces + 54 visitor bicycle parking spaces
Total	32 No. 1-bed units 98 No. 2-bed units 31 No. 3-bed units	32 bicycle parking spaces for 1-bed units + 196 bicycle parking spaces for 2-bed units + 93 bicycle parking spaces for 3-bed units + 81 bicycle parking spaces for apartment visitors	

Table 29 | Phase 2 North and South Sites – Bicycle Parking Spaces Required – DSNA 2018.

13.3 Bicycle Parking Proposed

The number of bicycle parking spaces projected to serve the proposed North and South Sites of Phase 2 development are presented below. The development's bicycle parking proposals include the provision of a total 568 No. bicycle parking spaces which will be provided within the communal rear gardens where appropriate, bike stores and within the curtilage of the property for houses.

Allocation of the proposed bicycle parking spaces for the overall Phase 2 development is outlined below: -

- **Allocated Parking – Apartments:** 188no. bicycle parking spaces, which equates to a ratio of 1.0 bicycle parking space per bedroom. Secure stores are located at ground floor level of the apartment blocks.
- **Short Term Parking – Apartments:** 58no. bicycle parking spaces, which equates to a ratio of 1.0 bicycle parking space per 2 apartment units. Parking spaces are located externally adjacent to the blocks.
- **Allocated Parking – Duplex: -**
 - **Communal Rear Garden/Patio Access:** 78 No. bicycle parking spaces.
 - **Within Bike Stores:** 63no. bicycle parking spaces located adjacent duplex blocks.
 - **Total:** 141no. bicycle parking spaces, which equates to a ratio of 1.0 bicycle parking space per bedroom, dedicated bicycle parking spaces are provided for the duplexes.
- **Short Term Parking – Duplex:** 28no. bicycle parking spaces, which equates to a ratio of 1.0 bicycle parking space per 2 duplex units is also provided.
- **Allocated Parking – Mid-Terrace Houses: -**
 - Within Bike Stores: 101no. bicycle parking spaces.
 - Total: 101no. bicycle parking spaces have been provided, for houses with direct access to gardens, bicycle parking can be readily accommodated within the rear curtilage of the property.
- **Short Term Parking – Houses:** 52no. bicycle parking spaces, which equates to a ratio of 1.0 bicycle parking space per 5 house units.

As can be seen from the above, the bicycle parking spaces projected for the proposed Phase 2 exceeds the standards of both Meath County Development Plan 2013 – 2019 and Design Standard for New Apartments – March 2018.

14. Road Safety

14.1 Accidents

Traffic collision data has been reviewed for the period of 2005-2016 from the Road Safety Authority (RSA) traffic collision database. This review will assist to identify any potential safety concerns in relation to the existing road network. These incidents are categorised into class of severity, which includes minor (M), serious (S), or fatal (F) collisions. The analysis is shown in Figure 14 below.

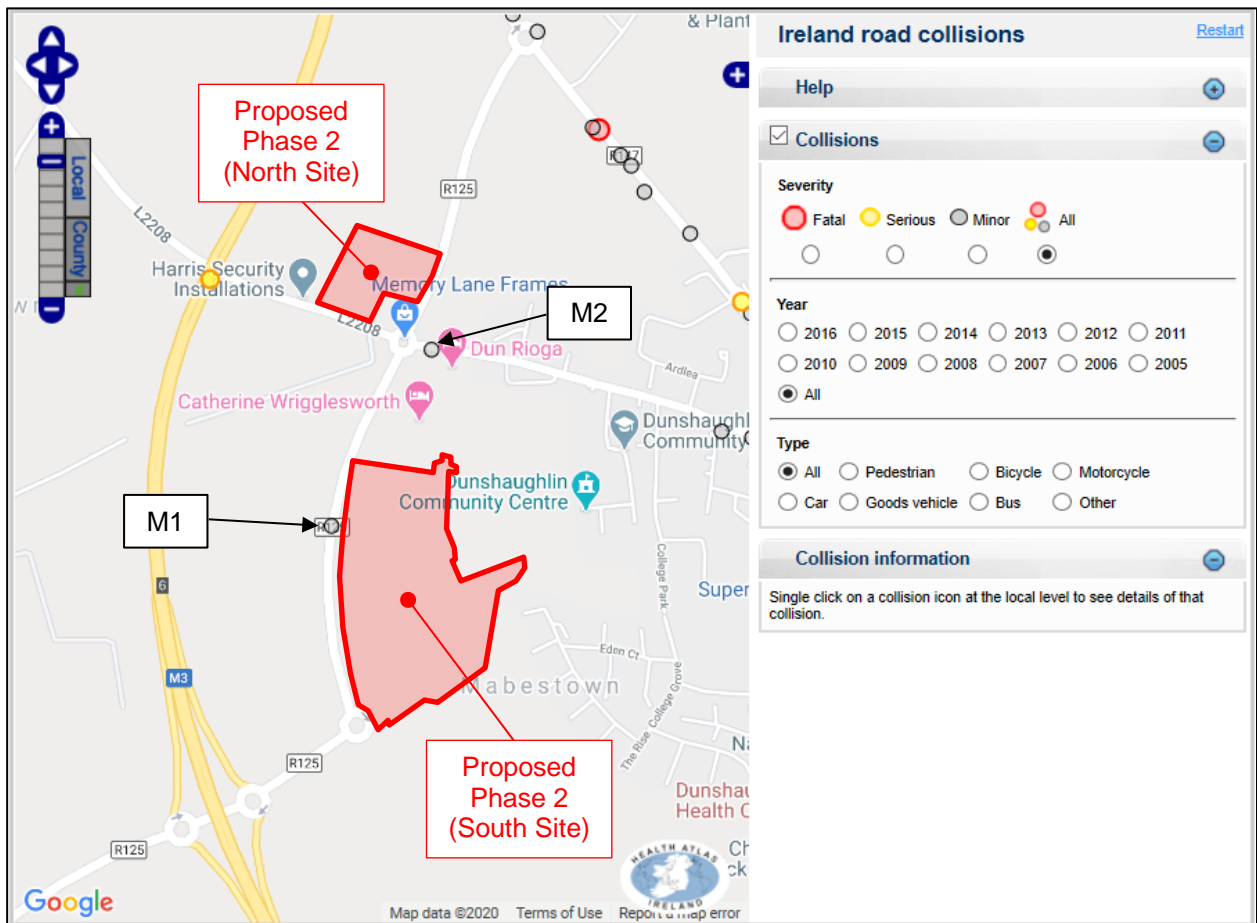

Figure 14 | RSA Traffic Collision Data – 2005 to 2016.

From the data obtained, there has been one minor collision that occurred on R125 along the frontage of the proposed South Site of Phase 2 and one minor collision that occurred on Drumree Road just before the roundabout with L2208 and R125. A summary of these two minor collisions is presented in Table 30 below.

Reference	Year	Vehicle	Circumstances	Day of Week	Time	Speed
M1	2014	Car	Single vehicle only	Sunday	19:00-23:00	80kph
M2	2008	Car	Angle, right turn	Monday	07:00-10:00	60Kph

Table 30 | Summary of Minor Collisions along R125 and Drumree Road.

15. Non-Technical Summary

Background

This Traffic and Transport Assessment (TTA) is a comprehensive review of all the potential transport impacts of the overall development, comprising of proposed (Phase 2), under-construction (Phase 1) and potential future (Neighbourhood Centre), including a detailed assessment of the local transportation systems and the impact of the cumulative development on the surrounding transportation network.

Location

The proposed Phase 2 development sites are located in Dunshaughlin, County Meath adjacent to R125 approximately 1.0km west of Dunshaughlin Town Centre.

Phase 2 will be developed in two distinct sites, labelled as North Site and South Site.

The **North Site** is bounded to the north and west by agricultural lands, to the south by the L2208 and to the east by the R125 Dunshaughlin Link Road. The North Site also surrounds an existing property in the south eastern corner of the site.

The **South Site** is bounded to the north by the under-construction development of Phase 1 (Reg. Ref. DA/120987), to the west by the R125, to the east by existing Dunshaughlin Community College and The Elms Residential development and to the south by agricultural lands.

Planning History

The proposed development is the second phase of an overall development located adjacent to R125 Dunshaughlin Link Road.

The Phase 1 residential development was approved by Meath County Council in April 2013 under Reg. Ref DA/120987 and is currently under construction nearing completion. The permission provided for the construction of 142 No. residential units and a creche to be delivered in two distinct areas - one the north and one to the south of Drumree Road.

As part of the under construction Phase 1 three access to the sites were also approved, two located on Drumree Road, each forming the minor arms of the approved four-armed signal controlled junction and one on R125 forming the eastern arm of the approved four-armed roundabout.

The proposed Phase 2 development will comprise a total of 415 No. residential units and a Creche to accommodate a total of 80 children and 16 staff on site. Phase 2 development is also proposed to be delivered in two distinct areas, one to the north of L2208 and west of R125 (North Site) and the other to the south of the approved Phase 1 and east of R125 (South Site).

The **North Site** will comprise a total of 149 No. residential units (95 No. houses, 20 No. duplexes and 34 No. apartments). Vehicular access to the North Site is proposed off L2208 via a new priority-controlled T-junction.

The **South Site** will comprise 266 No. residential units (159 No. houses, 35 No. duplexes and 72 No. apartments) and the Creche. Main vehicular accesses to the South Site will be provided off R125 Dunshaughlin Link Road, (a) via the roundabout approved under Phase 1 development (Reg. Ref. DA/120987) and (b) via the existing two-armed roundabout - at the southwestern edge of the site; which is proposed to be updated to a three-armed roundabout with the site access road forming the eastern arm. A

third access to the South Site will be provided from Drumree Road via the under-construction Phase 1 development.

Public Transport

The proposed development sites are located approximately 12,5km north of the closest train station - M3 Parkway, which is the terminus of the Docklands to M3 Parkway Western Commuter service.

The Commuter Rail service through M3 Parkway Station serves all stations from Docklands to M3 Parkway. The service operates at 3 – 4 services per hour on weekdays.

The M3 Parkway Station comprises c. 1,200 free park and ride spaces, providing the opportunity for those living in the surrounding cities and towns to commute by a car-train combined travel and to shift away from car-based travels to Dublin City.

Primary vehicular access to the M3 Parkway Station is via M3 (10-minute drive) with an alternative parallel route via R147 (15-minute).

The closest public bus stops are located in Dunshaughlin Town Centre, approximately 1km east of the sites. These bus stops are served by Bus Eireann Routes 109, 109A and 109B and connect Dunshaughlin to Dublin Airport, to Dublin City Centre and to Busaras Terminal. On the opposite direction, these routes connect Dunshaughlin to Navan, Kells and Trim. These Routes 109, 109A and 109B operate at peak hour frequencies of 30 minutes, Hourly and Every two hours, respectively.

Pedestrian access from the proposed development sites to the subject bus stops in Dunshaughlin Town Centre is via Drumree Road with a potential further access via the Skane River greenway.

Subject Planning Application

The proposed Phase 2 comprises a total of 415 No. residential units (254 houses, 55 duplexes and 106 apartments) and a Creche to accommodate a total of 80 children and 16 staff on site.

The **North Site** which is approximately 4.3 Ha in area will comprise 95 No. houses, 20 No. duplexes, and 34 No. apartments.

The **South Site** which is approximately 10.5 Ha in area will comprise 159 No. houses, 35 No. duplexes, 72 No. apartments, and the Creche.

The proposed Phase 2 development (North and South Sites) is programmed to be fully constructed and occupied by 2024.

Car Parking

A total of 664 No. car parking spaces will be provided including 442 No. car parking spaces for the houses, which equates to a ratio of approximately 1.7 car parking spaces per house unit; 161 No. car parking spaces for the apartments & duplexes, which equates to a ratio of 1.0 car parking spaces per apartment/duplex unit; 47 No. car parking spaces for visitors, 6 No. disabled car parking spaces and 8 No. car parking spaces to serve the Creche.

Bicycle Parking

A total of 568 No. bicycle parking spaces will be provided on site, including 246 No. bicycle spaces for the apartment units (188 long term and 58 short term); 169 No. bicycle parking spaces for the duplex units (141 long term and 28 short term) and 153 No. bicycle parking spaces for the houses (101 long term and 52 short term).

Junction Assessment

The results of the junction assessment indicate that all assessed junctions are operating within capacity in 2020 during both peak hours and will continue to do so in the future assessment year of 2039 DO SOMETHING.

Appendices

A. Traffic Survey

Survey Name: 046 20070 Dunshaughlin Phase 2
Date: Tue 25 Feb 2020

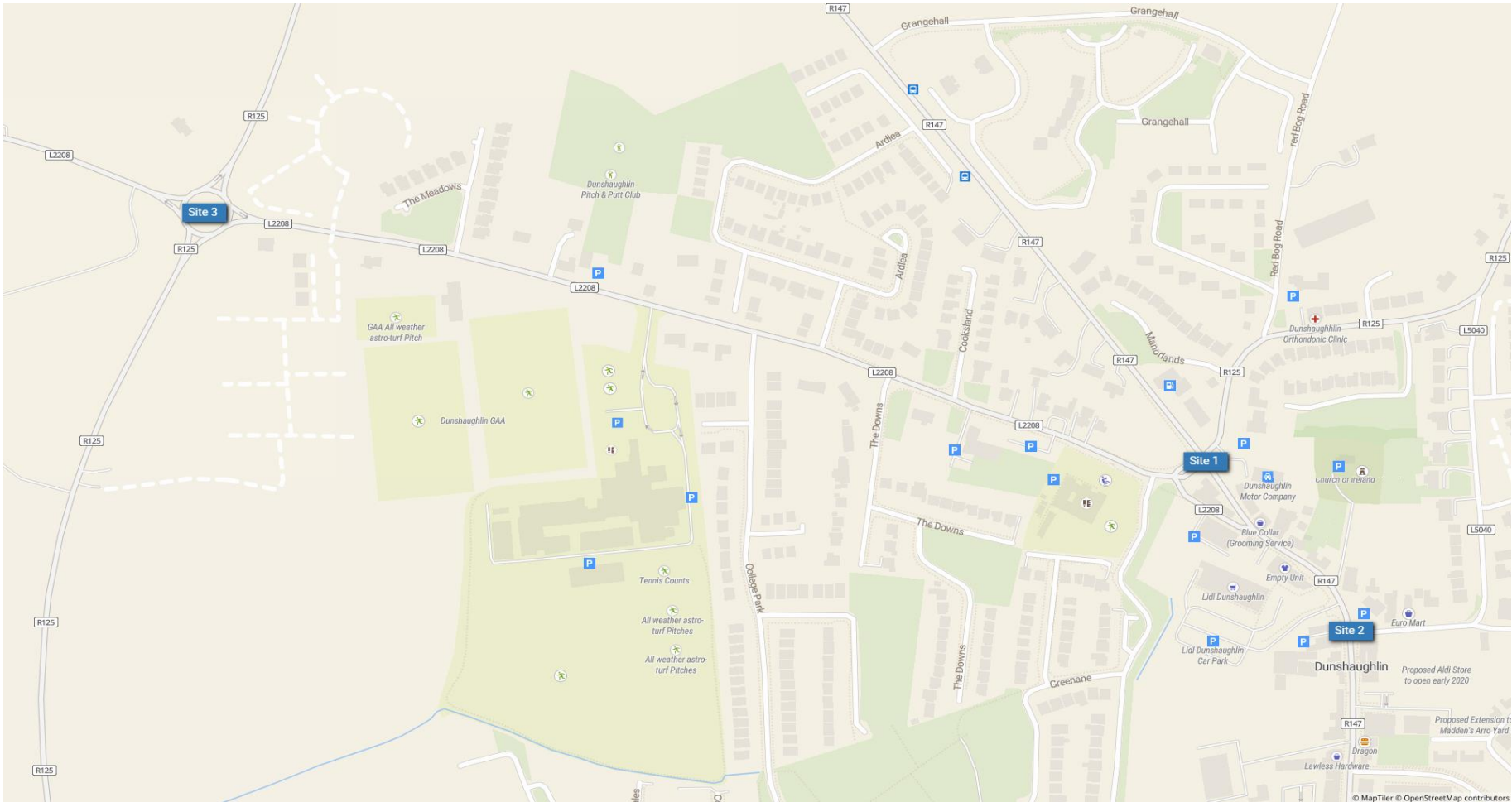

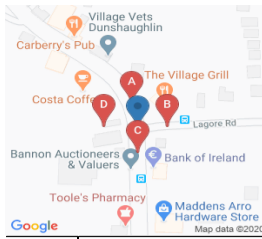

IDASO

Survey Name: 046 20070 Dunshaughlin Phase 2
Site: Site 2
Location: R147/Lagore Road/Main Street/Unnamed Road
Date: Tue 25-Feb-2020

Table with 48 columns (TIME, P/C, M/C, CAR, TAXI, LGV, OGV1, OGV2, PSV, TOT, PCU, etc.) and 144 rows (00:00 to 24:00). It provides detailed traffic data categorized into four directions (A=>A, A=>B, A=>C, A=>D) with metrics for various vehicle types and total counts.

D => A								D => B								D => C								D => D															
P/C	M/C	CAR	TAXI	LGV	OGV1	OGV2	PSV	TOT	PCU	P/C	M/C	CAR	TAXI	LGV	OGV1	OGV2	PSV	TOT	PCU	P/C	M/C	CAR	TAXI	LGV	OGV1	OGV2	PSV	TOT	PCU	P/C	M/C	CAR	TAXI	LGV	OGV1	OGV2	PSV	TOT	PCU
0	0	0	0	0	0	0	0	0	0	0	0	0	0	0	0	0	0	0	0	0	0	0	0	0	0	0	0	0	0	0	0	0	0	0	0	0	0		
0	0	761	4	59	3	3	0	830	835.4	0	2	212	0	10	1	0	0	225	224.3	1	0	421	2	35	1	1	1	462	464	0	0	0	0	1	0	0	1.5		



IDASO

Survey Name: 046 20070 Dunshaughlin Phase 2
Site: Site 3
Location: R125/Drumree Road/L2208
Date: Tue 25-Feb-2020

Table with columns for TIME, P/C, M/C, CAR, TAXI, LGV, OGV1, OGV2, PSV, TOT, PCU, and sub-columns for directions A=>A, A=>B, A=>C, and A=>D. The table contains detailed traffic count data for every 15-minute interval from 00:00 to 24:00, including a final 24 TOT row.

B. TRICS Output Report

Calculation Reference: AUDIT-561501-200716-0706

TRIP RATE CALCULATION SELECTION PARAMETERS:

Land Use : 03 - RESIDENTIAL
Category : A - HOUSES PRIVATELY OWNED
VEHICLES

Selected regions and areas:

14 LEINSTER
WC WICKLOW 2 days

This section displays the number of survey days per TRICS® sub-region in the selected set

Primary Filtering selection:

This data displays the chosen trip rate parameter and its selected range. Only sites that fall within the parameter range are included in the trip rate calculation.

Parameter: No of Dwellings
Actual Range: 45 to 50 (units:)
Range Selected by User: 10 to 71 (units:)

Parking Spaces Range: All Surveys Included

Parking Spaces per Dwelling Range: All Surveys Included

Bedrooms per Dwelling Range: All Surveys Included

Percentage of dwellings privately owned: All Surveys Included

Public Transport Provision:

Selection by: Include all surveys

Date Range: 01/01/12 to 28/05/18

This data displays the range of survey dates selected. Only surveys that were conducted within this date range are included in the trip rate calculation.

Selected survey days:

Monday 2 days

This data displays the number of selected surveys by day of the week.

Selected survey types:

Manual count 2 days
Directional ATC Count 0 days

This data displays the number of manual classified surveys and the number of unclassified ATC surveys, the total adding up to the overall number of surveys in the selected set. Manual surveys are undertaken using staff, whilst ATC surveys are undertaken using machines.

Selected Locations:

Edge of Town Centre 1
Edge of Town 1

This data displays the number of surveys per main location category within the selected set. The main location categories consist of Free Standing, Edge of Town, Suburban Area, Neighbourhood Centre, Edge of Town Centre, Town Centre and Not Known.

Selected Location Sub Categories:

Residential Zone 1
No Sub Category 1

This data displays the number of surveys per location sub-category within the selected set. The location sub-categories consist of Commercial Zone, Industrial Zone, Development Zone, Residential Zone, Retail Zone, Built-Up Zone, Village, Out of Town, High Street and No Sub Category.

Secondary Filtering selection:

Use Class:

C3 2 days

This data displays the number of surveys per Use Class classification within the selected set. The Use Classes Order 2005 has been used for this purpose, which can be found within the Library module of TRICS®.

Secondary Filtering selection (Cont.):

Population within 1 mile:

1,001 to 5,000	1 days
5,001 to 10,000	1 days

This data displays the number of selected surveys within stated 1-mile radii of population.

Population within 5 miles:

5,001 to 25,000	2 days
-----------------	--------

This data displays the number of selected surveys within stated 5-mile radii of population.

Car ownership within 5 miles:

0.6 to 1.0	2 days
------------	--------

This data displays the number of selected surveys within stated ranges of average cars owned per residential dwelling, within a radius of 5-miles of selected survey sites.

Travel Plan:

No	2 days
----	--------

This data displays the number of surveys within the selected set that were undertaken at sites with Travel Plans in place, and the number of surveys that were undertaken at sites without Travel Plans.

PTAL Rating:

No PTAL Present	2 days
-----------------	--------

This data displays the number of selected surveys with PTAL Ratings.

LIST OF SITES relevant to selection parameters

1	WC-03-A-01	DETACHED HOUSES	WICKLOW
	STATION ROAD		
	WICKLOW		
	CORPORATION MURRAGH		
	Edge of Town		
	No Sub Category		
	Total No of Dwellings:	50	
	Survey date: MONDAY	28/05/18	Survey Type: MANUAL
2	WC-03-A-02	DETACHED HOUSES	WICKLOW
	MARLTON ROAD		
	WICKLOW		
	FRIARSHILL		
	Edge of Town Centre		
	Residential Zone		
	Total No of Dwellings:	45	
	Survey date: MONDAY	28/05/18	Survey Type: MANUAL

This section provides a list of all survey sites and days in the selected set. For each individual survey site, it displays a unique site reference code and site address, the selected trip rate calculation parameter and its value, the day of the week and date of each survey, and whether the survey was a manual classified count or an ATC count.

TRIP RATE for Land Use 03 - RESIDENTIAL/A - HOUSES PRIVATELY OWNED
VEHICLES

Calculation factor: 1 DWELLS

BOLD print indicates peak (busiest) period

Time Range	ARRIVALS			DEPARTURES			TOTALS		
	No. Days	Ave. DWELLS	Trip Rate	No. Days	Ave. DWELLS	Trip Rate	No. Days	Ave. DWELLS	Trip Rate
00:00 - 01:00									
01:00 - 02:00									
02:00 - 03:00									
03:00 - 04:00									
04:00 - 05:00									
05:00 - 06:00									
06:00 - 07:00									
07:00 - 08:00	2	48	0.116	2	48	0.253	2	48	0.369
08:00 - 09:00	2	48	0.295	2	48	0.674	2	48	0.969
09:00 - 10:00	2	48	0.253	2	48	0.305	2	48	0.558
10:00 - 11:00	2	48	0.211	2	48	0.242	2	48	0.453
11:00 - 12:00	2	48	0.200	2	48	0.232	2	48	0.432
12:00 - 13:00	2	48	0.263	2	48	0.200	2	48	0.463
13:00 - 14:00	2	48	0.263	2	48	0.295	2	48	0.558
14:00 - 15:00	2	48	0.411	2	48	0.316	2	48	0.727
15:00 - 16:00	2	48	0.432	2	48	0.421	2	48	0.853
16:00 - 17:00	2	48	0.411	2	48	0.253	2	48	0.664
17:00 - 18:00	2	48	0.432	2	48	0.253	2	48	0.685
18:00 - 19:00	2	48	0.379	2	48	0.453	2	48	0.832
19:00 - 20:00									
20:00 - 21:00									
21:00 - 22:00									
22:00 - 23:00									
23:00 - 24:00									
Total Rates:			3.666			3.897			7.563

This section displays the trip rate results based on the selected set of surveys and the selected count type (shown just above the table). It is split by three main columns, representing arrivals trips, departures trips, and total trips (arrivals plus departures). Within each of these main columns are three sub-columns. These display the number of survey days where count data is included (per time period), the average value of the selected trip rate calculation parameter (per time period), and the trip rate result (per time period). Total trip rates (the sum of the column) are also displayed at the foot of the table.

To obtain a trip rate, the average (mean) trip rate parameter value (TRP) is first calculated for all selected survey days that have count data available for the stated time period. The average (mean) number of arrivals, departures or totals (whichever applies) is also calculated (COUNT) for all selected survey days that have count data available for the stated time period. Then, the average count is divided by the average trip rate parameter value, and multiplied by the stated calculation factor (shown just above the table and abbreviated here as FACT). So, the method is: $COUNT/TRP*FACT$. Trip rates are then rounded to 3 decimal places.

The survey data, graphs and all associated supporting information, contained within the TRICS Database are published by TRICS Consortium Limited ("the Company") and the Company claims copyright and database rights in this published work. The Company authorises those who possess a current TRICS licence to access the TRICS Database and copy the data contained within the TRICS Database for the licence holders' use only. Any resulting copy must retain all copyrights and other proprietary notices, and any disclaimer contained thereon.

The Company accepts no responsibility for loss which may arise from reliance on data contained in the TRICS Database. [No warranty of any kind, express or implied, is made as to the data contained in the TRICS Database.]

Parameter summary

Trip rate parameter range selected: 45 - 50 (units:)
Survey date range: 01/01/12 - 28/05/18
Number of weekdays (Monday-Friday): 2
Number of Saturdays: 0
Number of Sundays: 0
Surveys automatically removed from selection: 0
Surveys manually removed from selection: 0

This section displays a quick summary of some of the data filtering selections made by the TRICS® user. The trip rate calculation parameter range of all selected surveys is displayed first, followed by the range of minimum and maximum survey dates selected by the user. Then, the total number of selected weekdays and weekend days in the selected set of surveys are shown. Finally, the number of survey days that have been manually removed from the selected set outside of the standard filtering procedure are displayed.

Calculation Reference: AUDIT-561501-200716-0729

TRIP RATE CALCULATION SELECTION PARAMETERS:

Land Use : 03 - RESIDENTIAL
 Category : C - FLATS PRIVATELY OWNED

VEHICLES

Selected regions and areas:

12	CONNAUGHT	
	GA GALWAY	1 days
13	MUNSTER	
	WA WATERFORD	1 days
15	GREATER DUBLIN	
	DL DUBLIN	4 days
17	ULSTER (NORTHERN IRELAND)	
	AN ANTRIM	1 days

This section displays the number of survey days per TRICS® sub-region in the selected set

Primary Filtering selection:

This data displays the chosen trip rate parameter and its selected range. Only sites that fall within the parameter range are included in the trip rate calculation.

Parameter: No of Dwellings
 Actual Range: 20 to 140 (units:)
 Range Selected by User: 18 to 372 (units:)

Parking Spaces Range: All Surveys Included

Parking Spaces per Dwelling Range: All Surveys Included

Bedrooms per Dwelling Range: All Surveys Included

Percentage of dwellings privately owned: All Surveys Included

Public Transport Provision:

Selection by: Include all surveys

Date Range: 01/01/12 to 22/11/16

This data displays the range of survey dates selected. Only surveys that were conducted within this date range are included in the trip rate calculation.

Selected survey days:

Tuesday	4 days
Wednesday	1 days
Thursday	1 days
Friday	1 days

This data displays the number of selected surveys by day of the week.

Selected survey types:

Manual count	7 days
Directional ATC Count	0 days

This data displays the number of manual classified surveys and the number of unclassified ATC surveys, the total adding up to the overall number of surveys in the selected set. Manual surveys are undertaken using staff, whilst ATC surveys are undertaken using machines.

Selected Locations:

Suburban Area (PPS6 Out of Centre)	6
Edge of Town	1

This data displays the number of surveys per main location category within the selected set. The main location categories consist of Free Standing, Edge of Town, Suburban Area, Neighbourhood Centre, Edge of Town Centre, Town Centre and Not Known.

Selected Location Sub Categories:

Residential Zone	6
No Sub Category	1

This data displays the number of surveys per location sub-category within the selected set. The location sub-categories consist of Commercial Zone, Industrial Zone, Development Zone, Residential Zone, Retail Zone, Built-Up Zone, Village, Out of Town, High Street and No Sub Category.

Secondary Filtering selection:

Use Class:

C3 7 days

This data displays the number of surveys per Use Class classification within the selected set. The Use Classes Order 2005 has been used for this purpose, which can be found within the Library module of TRICS®.

Population within 1 mile:

5,001 to 10,000 1 days
15,001 to 20,000 1 days
20,001 to 25,000 1 days
25,001 to 50,000 4 days

This data displays the number of selected surveys within stated 1-mile radii of population.

Population within 5 miles:

50,001 to 75,000 2 days
125,001 to 250,000 1 days
250,001 to 500,000 1 days
500,001 or More 3 days

This data displays the number of selected surveys within stated 5-mile radii of population.

Car ownership within 5 miles:

0.6 to 1.0 3 days
1.1 to 1.5 4 days

This data displays the number of selected surveys within stated ranges of average cars owned per residential dwelling, within a radius of 5-miles of selected survey sites.

Travel Plan:

No 7 days

This data displays the number of surveys within the selected set that were undertaken at sites with Travel Plans in place, and the number of surveys that were undertaken at sites without Travel Plans.

PTAL Rating:

No PTAL Present 7 days

This data displays the number of selected surveys with PTAL Ratings.

LIST OF SITES relevant to selection parameters

1	AN-03-C-02	BLOCK OF FLATS	ANTRIM
	SUMMERHILL AVENUE		
	BELFAST		
	KNOCK		
	Edge of Town		
	Residential Zone		
	Total No of Dwellings:	22	
	Survey date: <i>FRIDAY</i>	<i>28/11/14</i>	Survey Type: <i>MANUAL</i>
2	DL-03-C-12	BLOCK OF FLATS	DUBLIN
	BOOTERSTOWN AVENUE		
	DUBLIN		
	Suburban Area (PPS6 Out of Centre)		
	Residential Zone		
	Total No of Dwellings:	47	
	Survey date: <i>TUESDAY</i>	<i>10/09/13</i>	Survey Type: <i>MANUAL</i>
3	DL-03-C-14	BLOCKS OF FLATS	DUBLIN
	BALLINTEER ROAD		
	DUBLIN		
	DUNDRUM		
	Suburban Area (PPS6 Out of Centre)		
	Residential Zone		
	Total No of Dwellings:	140	
	Survey date: <i>TUESDAY</i>	<i>10/09/13</i>	Survey Type: <i>MANUAL</i>
4	DL-03-C-15	BLOCKS OF FLATS	DUBLIN
	MONKSTOWN ROAD		
	DUBLIN		
	MONKSTOWN		
	Suburban Area (PPS6 Out of Centre)		
	Residential Zone		
	Total No of Dwellings:	20	
	Survey date: <i>WEDNESDAY</i>	<i>01/10/14</i>	Survey Type: <i>MANUAL</i>
5	DL-03-C-16	BLOCKS OF FLATS	DUBLIN
	BOTANIC AVENUE		
	DUBLIN		
	DRUMCONDRA		
	Suburban Area (PPS6 Out of Centre)		
	Residential Zone		
	Total No of Dwellings:	31	
	Survey date: <i>TUESDAY</i>	<i>22/11/16</i>	Survey Type: <i>MANUAL</i>
6	GA-03-C-01	FLATS	GALWAY
	BALLYLOUGHANE ROAD		
	GALWAY		
	Suburban Area (PPS6 Out of Centre)		
	No Sub Category		
	Total No of Dwellings:	34	
	Survey date: <i>THURSDAY</i>	<i>31/10/13</i>	Survey Type: <i>MANUAL</i>
7	WA-03-C-01	BLOCKS OF FLATS	WATERFORD
	UPPER YELLOW ROAD		
	WATERFORD		
	Suburban Area (PPS6 Out of Centre)		
	Residential Zone		
	Total No of Dwellings:	51	
	Survey date: <i>TUESDAY</i>	<i>12/05/15</i>	Survey Type: <i>MANUAL</i>

This section provides a list of all survey sites and days in the selected set. For each individual survey site, it displays a unique site reference code and site address, the selected trip rate calculation parameter and its value, the day of the week and date of each survey, and whether the survey was a manual classified count or an ATC count.

TRIP RATE for Land Use 03 - RESIDENTIAL/C - FLATS PRIVATELY OWNED
VEHICLES

Calculation factor: 1 DWELLS

BOLD print indicates peak (busiest) period

Time Range	ARRIVALS			DEPARTURES			TOTALS		
	No. Days	Ave. DWELLS	Trip Rate	No. Days	Ave. DWELLS	Trip Rate	No. Days	Ave. DWELLS	Trip Rate
00:00 - 01:00									
01:00 - 02:00									
02:00 - 03:00									
03:00 - 04:00									
04:00 - 05:00									
05:00 - 06:00									
06:00 - 07:00									
07:00 - 08:00	7	49	0.020	7	49	0.183	7	49	0.203
08:00 - 09:00	7	49	0.046	7	49	0.241	7	49	0.287
09:00 - 10:00	7	49	0.064	7	49	0.136	7	49	0.200
10:00 - 11:00	7	49	0.041	7	49	0.058	7	49	0.099
11:00 - 12:00	7	49	0.067	7	49	0.087	7	49	0.154
12:00 - 13:00	7	49	0.090	7	49	0.096	7	49	0.186
13:00 - 14:00	7	49	0.075	7	49	0.072	7	49	0.147
14:00 - 15:00	7	49	0.128	7	49	0.058	7	49	0.186
15:00 - 16:00	7	49	0.119	7	49	0.075	7	49	0.194
16:00 - 17:00	7	49	0.122	7	49	0.070	7	49	0.192
17:00 - 18:00	7	49	0.212	7	49	0.055	7	49	0.267
18:00 - 19:00	7	49	0.194	7	49	0.104	7	49	0.298
19:00 - 20:00									
20:00 - 21:00									
21:00 - 22:00									
22:00 - 23:00									
23:00 - 24:00									
Total Rates:			1.178			1.235			2.413

This section displays the trip rate results based on the selected set of surveys and the selected count type (shown just above the table). It is split by three main columns, representing arrivals trips, departures trips, and total trips (arrivals plus departures). Within each of these main columns are three sub-columns. These display the number of survey days where count data is included (per time period), the average value of the selected trip rate calculation parameter (per time period), and the trip rate result (per time period). Total trip rates (the sum of the column) are also displayed at the foot of the table.

*To obtain a trip rate, the average (mean) trip rate parameter value (TRP) is first calculated for all selected survey days that have count data available for the stated time period. The average (mean) number of arrivals, departures or totals (whichever applies) is also calculated (COUNT) for all selected survey days that have count data available for the stated time period. Then, the average count is divided by the average trip rate parameter value, and multiplied by the stated calculation factor (shown just above the table and abbreviated here as FACT). So, the method is: COUNT/TRP*FACT. Trip rates are then rounded to 3 decimal places.*

The survey data, graphs and all associated supporting information, contained within the TRICS Database are published by TRICS Consortium Limited ("the Company") and the Company claims copyright and database rights in this published work. The Company authorises those who possess a current TRICS licence to access the TRICS Database and copy the data contained within the TRICS Database for the licence holders' use only. Any resulting copy must retain all copyrights and other proprietary notices, and any disclaimer contained thereon.

The Company accepts no responsibility for loss which may arise from reliance on data contained in the TRICS Database. [No warranty of any kind, express or implied, is made as to the data contained in the TRICS Database.]

Parameter summary

Trip rate parameter range selected: 20 - 140 (units:)
 Survey date range: 01/01/12 - 22/11/16
 Number of weekdays (Monday-Friday): 7
 Number of Saturdays: 0
 Number of Sundays: 0
 Surveys automatically removed from selection: 0
 Surveys manually removed from selection: 0

This section displays a quick summary of some of the data filtering selections made by the TRICS® user. The trip rate calculation parameter range of all selected surveys is displayed first, followed by the range of minimum and maximum survey dates selected by the user. Then, the total number of selected weekdays and weekend days in the selected set of surveys are shown. Finally, the number of survey days that have been manually removed from the selected set outside of the standard filtering procedure are displayed.

Calculation Reference: AUDIT-561501-200716-0733

TRIP RATE CALCULATION SELECTION PARAMETERS:

Land Use : 04 - EDUCATION

Category : D - NURSERY

VEHICLES

Selected regions and areas:

12 CONNAUGHT
RO ROSCOMMON 2 days

This section displays the number of survey days per TRICS® sub-region in the selected set

Primary Filtering selection:

This data displays the chosen trip rate parameter and its selected range. Only sites that fall within the parameter range are included in the trip rate calculation.

Parameter: Gross floor area
Actual Range: 500 to 509 (units: sqm)
Range Selected by User: 256 to 1300 (units: sqm)

Parking Spaces Range: All Surveys Included

Public Transport Provision:

Selection by: Include all surveys

Date Range: 01/01/12 to 27/04/18

This data displays the range of survey dates selected. Only surveys that were conducted within this date range are included in the trip rate calculation.

Selected survey days:

Friday 2 days

This data displays the number of selected surveys by day of the week.

Selected survey types:

Manual count 2 days
Directional ATC Count 0 days

This data displays the number of manual classified surveys and the number of unclassified ATC surveys, the total adding up to the overall number of surveys in the selected set. Manual surveys are undertaken using staff, whilst ATC surveys are undertaken using machines.

Selected Locations:

Edge of Town Centre 1
Edge of Town 1

This data displays the number of surveys per main location category within the selected set. The main location categories consist of Free Standing, Edge of Town, Suburban Area, Neighbourhood Centre, Edge of Town Centre, Town Centre and Not Known.

Selected Location Sub Categories:

Residential Zone 2

This data displays the number of surveys per location sub-category within the selected set. The location sub-categories consist of Commercial Zone, Industrial Zone, Development Zone, Residential Zone, Retail Zone, Built-Up Zone, Village, Out of Town, High Street and No Sub Category.

Secondary Filtering selection:

Use Class:

D1 2 days

This data displays the number of surveys per Use Class classification within the selected set. The Use Classes Order 2005 has been used for this purpose, which can be found within the Library module of TRICS®.

Secondary Filtering selection (Cont.):

Population within 1 mile:

1,001 to 5,000	1 days
5,001 to 10,000	1 days

This data displays the number of selected surveys within stated 1-mile radii of population.

Population within 5 miles:

5,001 to 25,000	2 days
-----------------	--------

This data displays the number of selected surveys within stated 5-mile radii of population.

Car ownership within 5 miles:

1.1 to 1.5	2 days
------------	--------

This data displays the number of selected surveys within stated ranges of average cars owned per residential dwelling, within a radius of 5-miles of selected survey sites.

Travel Plan:

No	2 days
----	--------

This data displays the number of surveys within the selected set that were undertaken at sites with Travel Plans in place, and the number of surveys that were undertaken at sites without Travel Plans.

PTAL Rating:

No PTAL Present	2 days
-----------------	--------

This data displays the number of selected surveys with PTAL Ratings.

LIST OF SITES relevant to selection parameters

1	RO-04-D-01	NURSERY		ROSCOMMON
	PARK VIEW			
	ROSCOMMON			
	CRUBY HILL			
	Edge of Town			
	Residential Zone			
	Total Gross floor area:		500 sqm	
	<i>Survey date: FRIDAY</i>		<i>26/09/14</i>	<i>Survey Type: MANUAL</i>
2	RO-04-D-02	NURSERY		ROSCOMMON
	CIRCULAR ROAD			
	ROSCOMMON			
	BALLYPHEASAN			
	Edge of Town Centre			
	Residential Zone			
	Total Gross floor area:		509 sqm	
	<i>Survey date: FRIDAY</i>		<i>27/04/18</i>	<i>Survey Type: MANUAL</i>

This section provides a list of all survey sites and days in the selected set. For each individual survey site, it displays a unique site reference code and site address, the selected trip rate calculation parameter and its value, the day of the week and date of each survey, and whether the survey was a manual classified count or an ATC count.

TRIP RATE for Land Use 04 - EDUCATION/D - NURSERY

VEHICLES

Calculation factor: 100 sqm

BOLD print indicates peak (busiest) period

Time Range	ARRIVALS			DEPARTURES			TOTALS		
	No. Days	Ave. GFA	Trip Rate	No. Days	Ave. GFA	Trip Rate	No. Days	Ave. GFA	Trip Rate
00:00 - 01:00									
01:00 - 02:00									
02:00 - 03:00									
03:00 - 04:00									
04:00 - 05:00									
05:00 - 06:00									
06:00 - 07:00									
07:00 - 08:00	2	505	0.496	2	505	0.297	2	505	0.793
08:00 - 09:00	2	505	5.946	2	505	3.271	2	505	9.217
09:00 - 10:00	2	505	5.649	2	505	6.244	2	505	11.893
10:00 - 11:00	2	505	0.396	2	505	0.793	2	505	1.189
11:00 - 12:00	2	505	1.586	2	505	0.396	2	505	1.982
12:00 - 13:00	2	505	3.271	2	505	4.460	2	505	7.731
13:00 - 14:00	2	505	1.982	2	505	1.982	2	505	3.964
14:00 - 15:00	2	505	2.279	2	505	1.288	2	505	3.567
15:00 - 16:00	2	505	0.892	2	505	1.982	2	505	2.874
16:00 - 17:00	2	505	1.982	2	505	2.081	2	505	4.063
17:00 - 18:00	2	505	3.766	2	505	5.055	2	505	8.821
18:00 - 19:00	2	505	0.000	2	505	0.793	2	505	0.793
19:00 - 20:00									
20:00 - 21:00									
21:00 - 22:00									
22:00 - 23:00									
23:00 - 24:00									
Total Rates:			28.245			28.642			56.887

This section displays the trip rate results based on the selected set of surveys and the selected count type (shown just above the table). It is split by three main columns, representing arrivals trips, departures trips, and total trips (arrivals plus departures). Within each of these main columns are three sub-columns. These display the number of survey days where count data is included (per time period), the average value of the selected trip rate calculation parameter (per time period), and the trip rate result (per time period). Total trip rates (the sum of the column) are also displayed at the foot of the table.

To obtain a trip rate, the average (mean) trip rate parameter value (TRP) is first calculated for all selected survey days that have count data available for the stated time period. The average (mean) number of arrivals, departures or totals (whichever applies) is also calculated (COUNT) for all selected survey days that have count data available for the stated time period. Then, the average count is divided by the average trip rate parameter value, and multiplied by the stated calculation factor (shown just above the table and abbreviated here as FACT). So, the method is: $COUNT/TRP*FACT$. Trip rates are then rounded to 3 decimal places.

The survey data, graphs and all associated supporting information, contained within the TRICS Database are published by TRICS Consortium Limited ("the Company") and the Company claims copyright and database rights in this published work. The Company authorises those who possess a current TRICS licence to access the TRICS Database and copy the data contained within the TRICS Database for the licence holders' use only. Any resulting copy must retain all copyrights and other proprietary notices, and any disclaimer contained thereon.

The Company accepts no responsibility for loss which may arise from reliance on data contained in the TRICS Database. [No warranty of any kind, express or implied, is made as to the data contained in the TRICS Database.]

Parameter summary

Trip rate parameter range selected:	500 - 509 (units: sqm)
Survey date range:	01/01/12 - 27/04/18
Number of weekdays (Monday-Friday):	2
Number of Saturdays:	0
Number of Sundays:	0
Surveys automatically removed from selection:	0
Surveys manually removed from selection:	0

This section displays a quick summary of some of the data filtering selections made by the TRICS® user. The trip rate calculation parameter range of all selected surveys is displayed first, followed by the range of minimum and maximum survey dates selected by the user. Then, the total number of selected weekdays and weekend days in the selected set of surveys are shown. Finally, the number of survey days that have been manually removed from the selected set outside of the standard filtering procedure are displayed.

C. Trip Distribution/Assignment and Traffic Forecast

FIGURE A - TRIP DISTRIBUTION - NORTH SITE OF PROPOSED PHASE 2 DEVELOPMENT

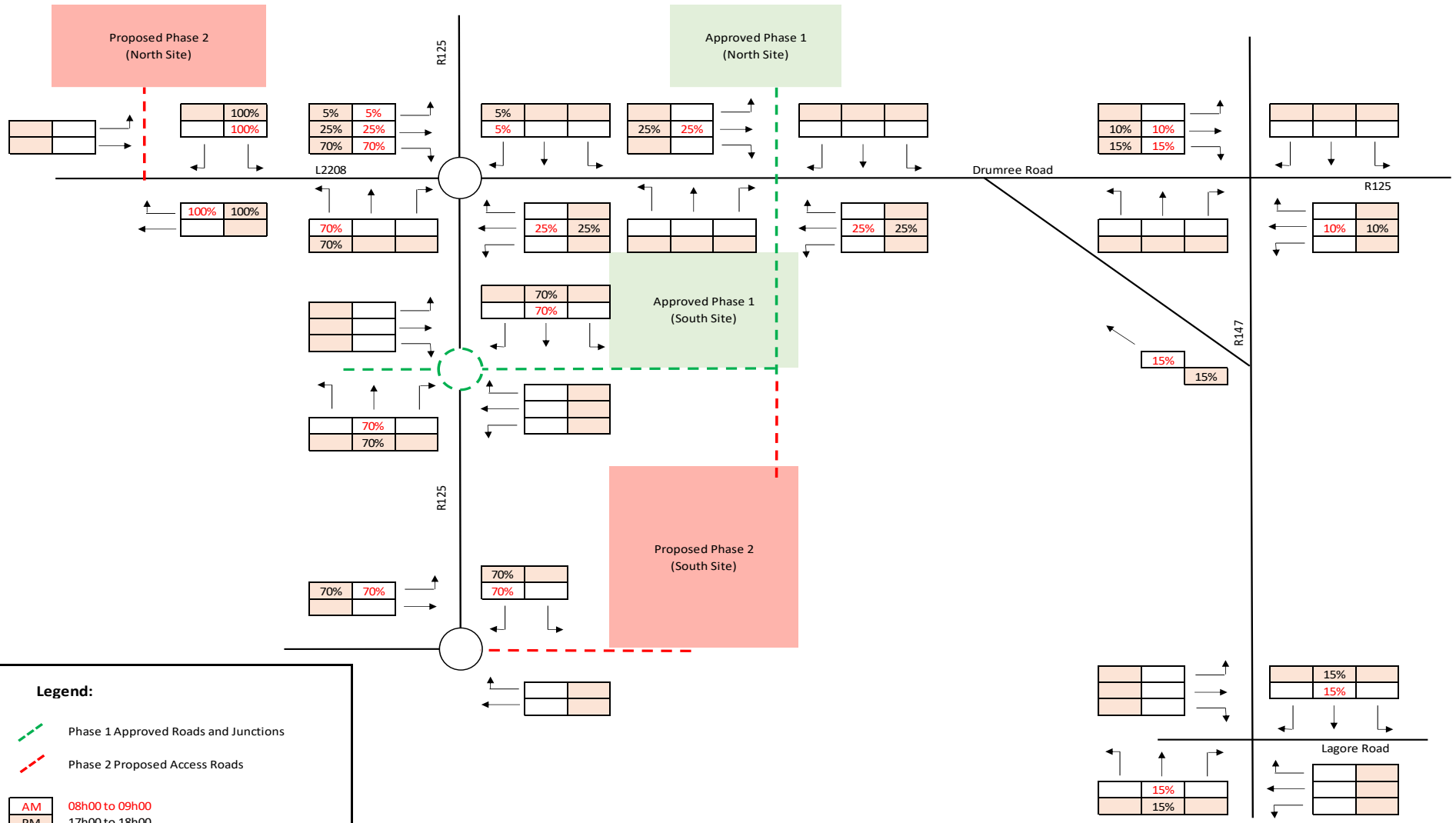

FIGURE B - TRIP ASSIGNMENT - NORTH SITE OF PROPOSED PHASE 2 DEVELOPMENT

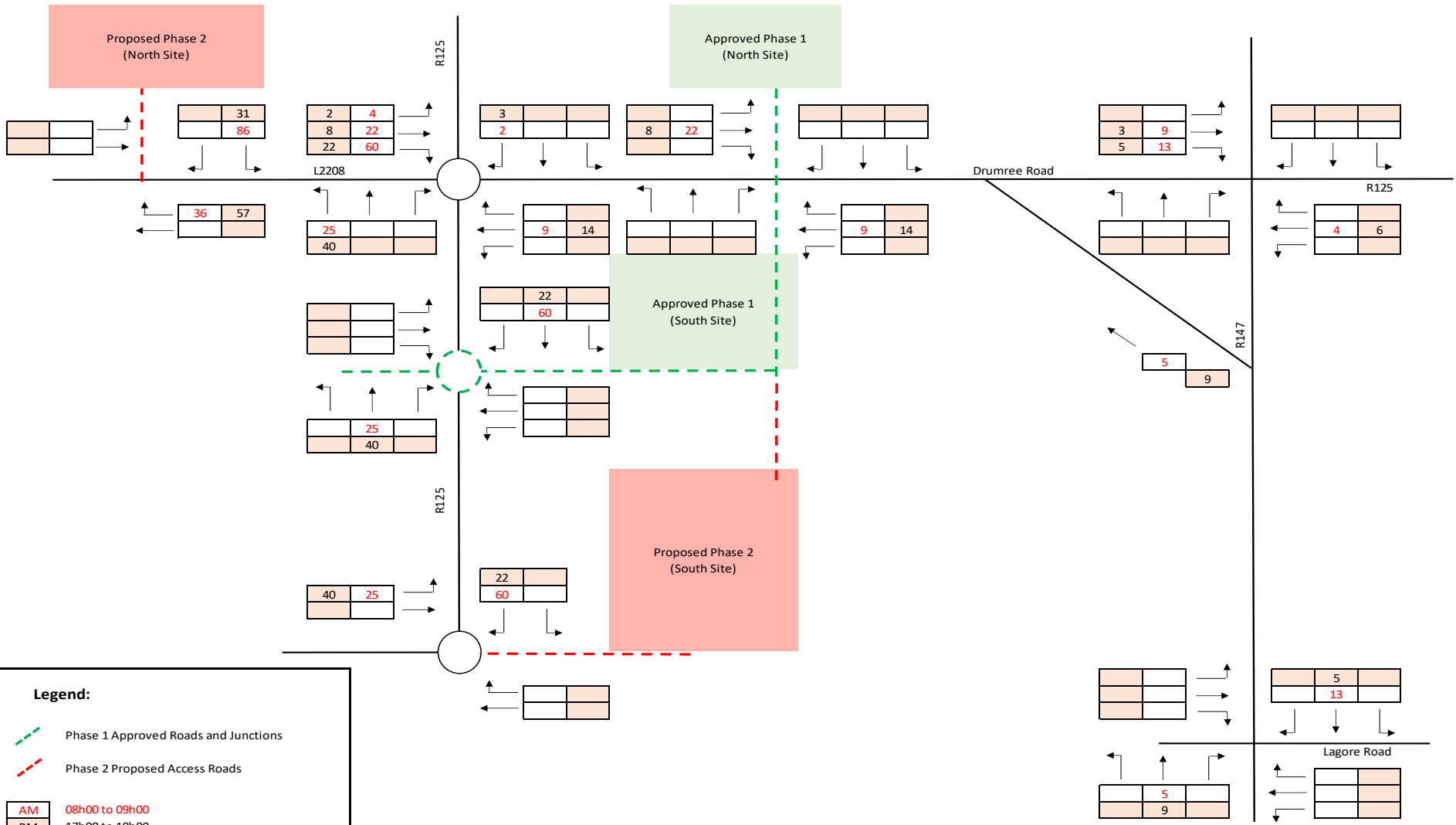

FIGURE C - TRIP DISTRIBUTION - SOUTH SITE OF PROPOSED PHASE 2 DEVELOPMENT

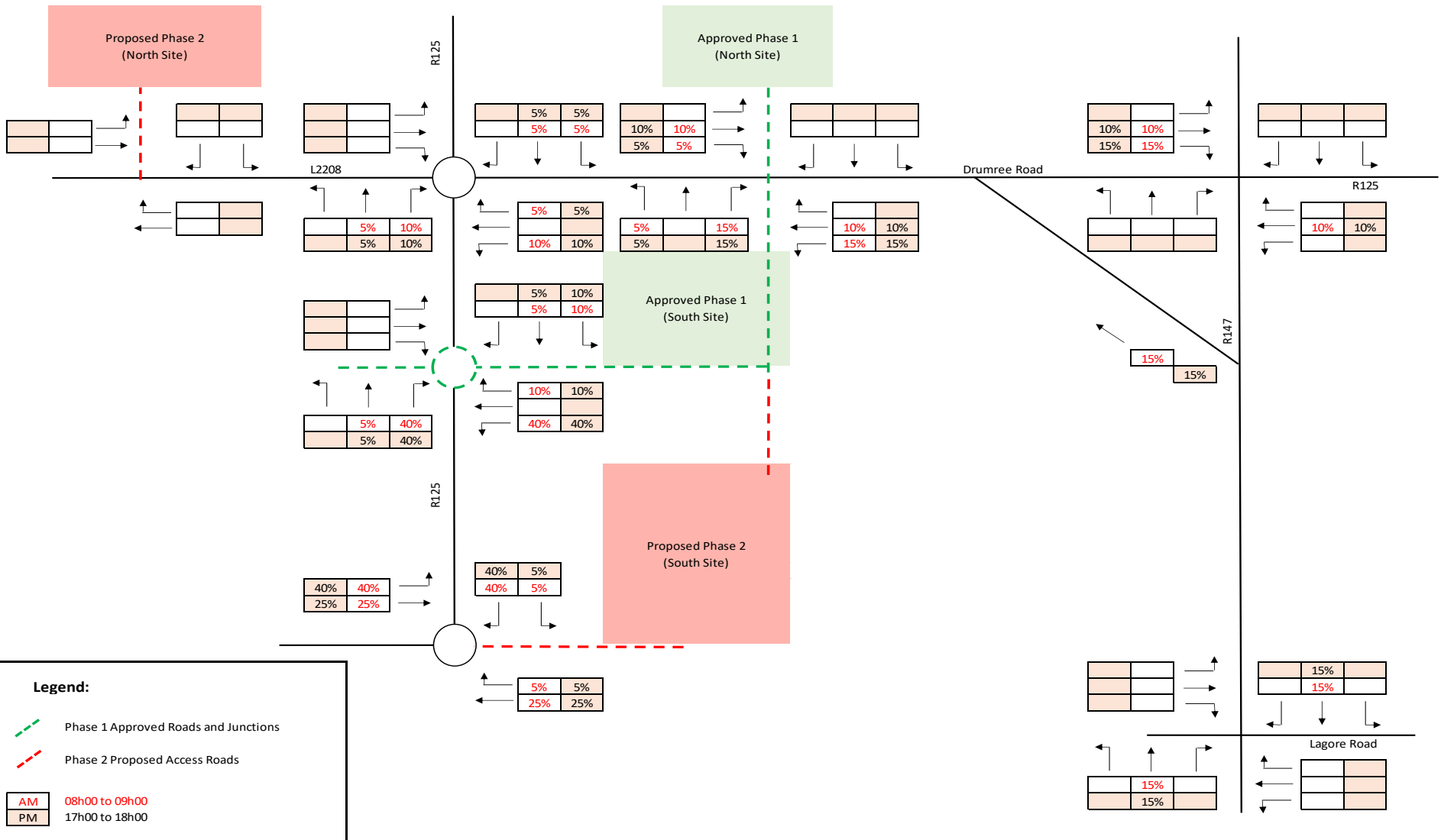
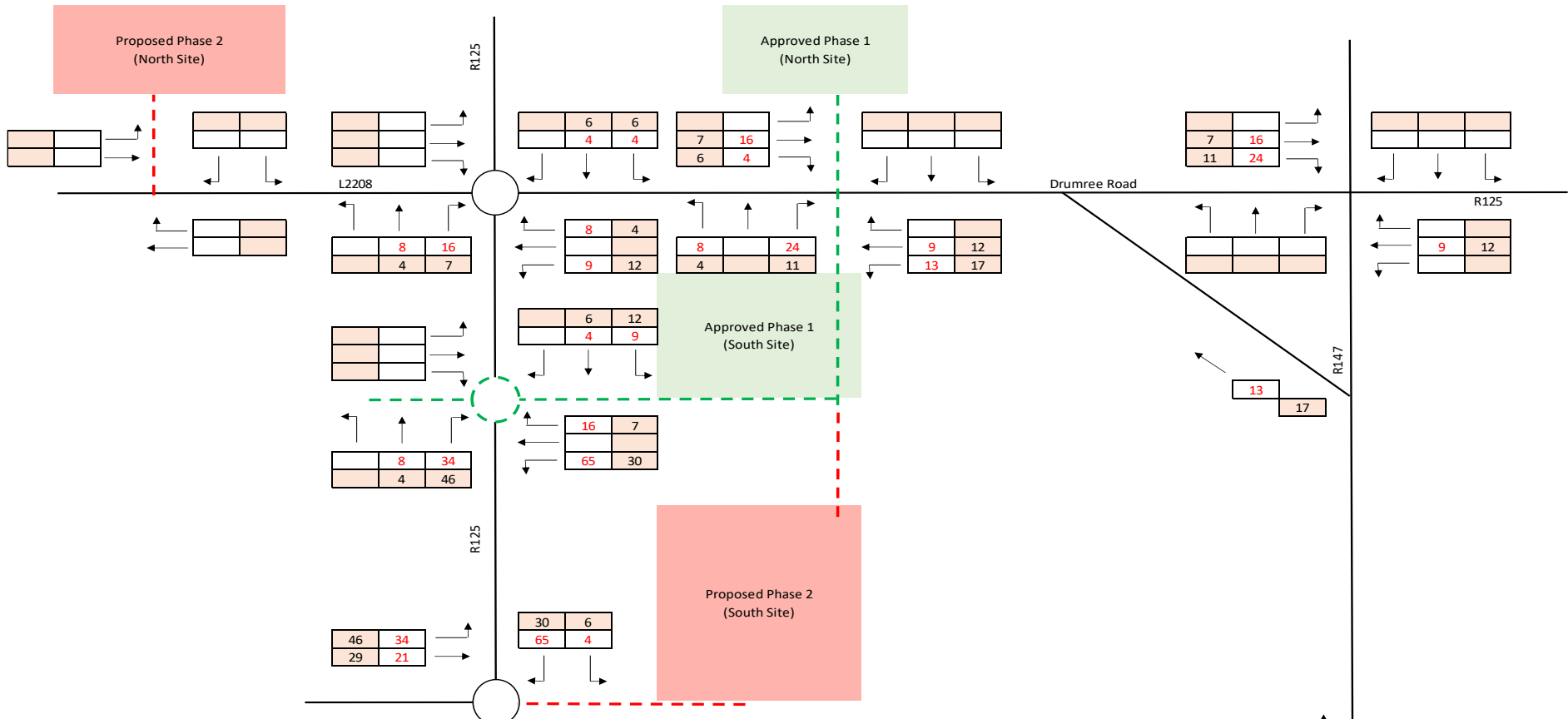

FIGURE D - TRIP ASSIGNMENT - SOUTH SITE OF PROPOSED PHASE 2 DEVELOPMENT



Legend:

- Phase 1 Approved Roads and Junctions
- Phase 2 Proposed Access Roads

AM	08h00 to 09h00
PM	17h00 to 18h00

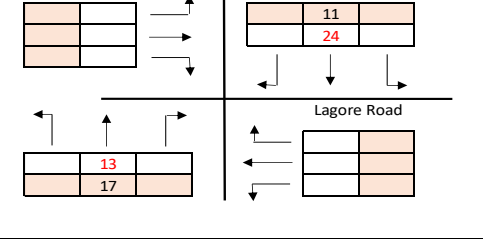

FIGURE E - TRIP DISTRIBUTION - NORTH SITE OF APPROVED PHASE 1 DEVELOPMENT (DA/120987)

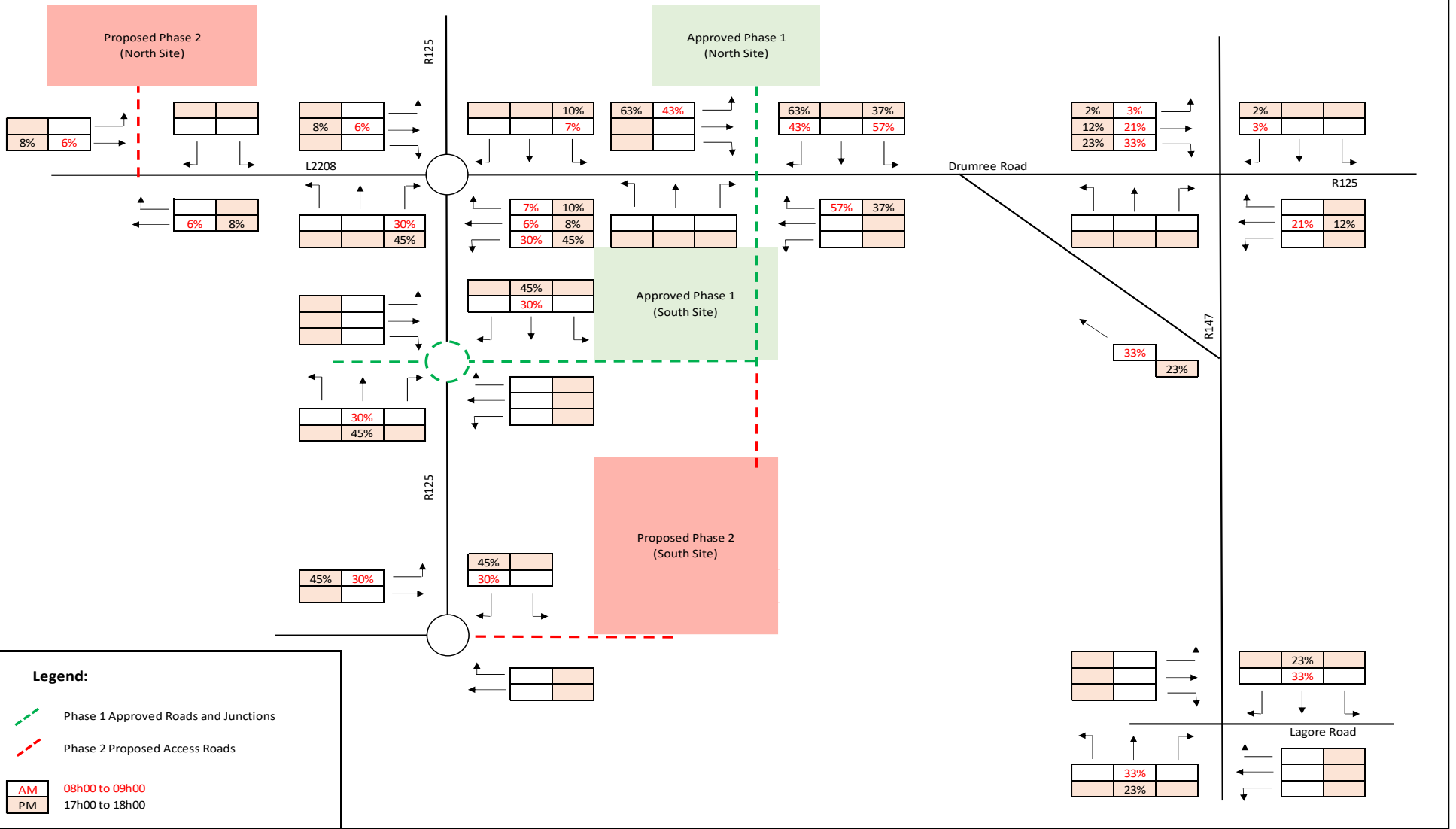

FIGURE F - TRIP DISTRIBUTION - SOUTH SITE OF APPROVED PHASE 1 DEVELOPMENT (DA/120987)

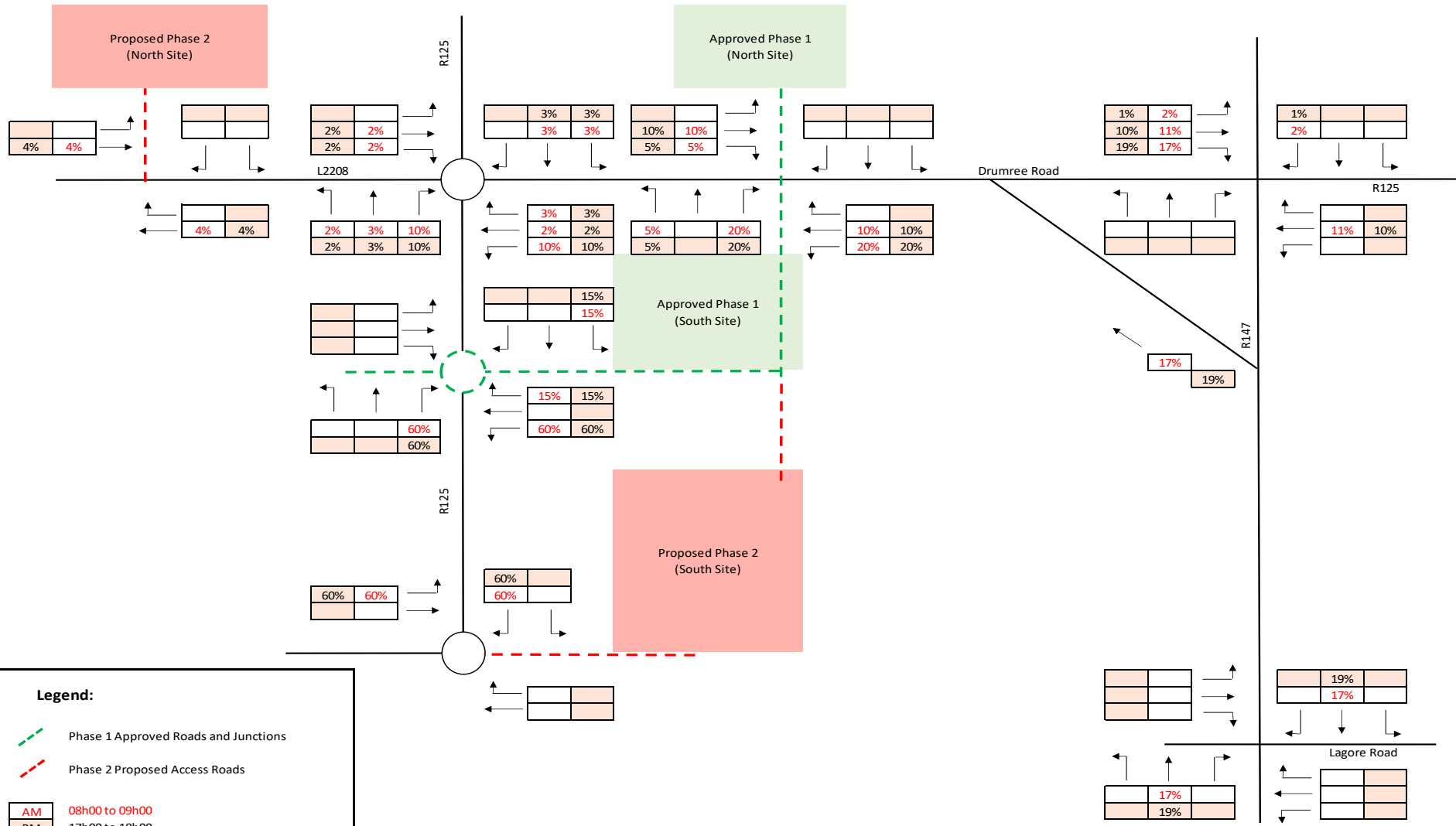

FIGURE G - TRIP ASSIGNMENT - APPROVED PHASE 1 DEVELOPMENT NORTH AND SOUTH SITES (DA/120987)

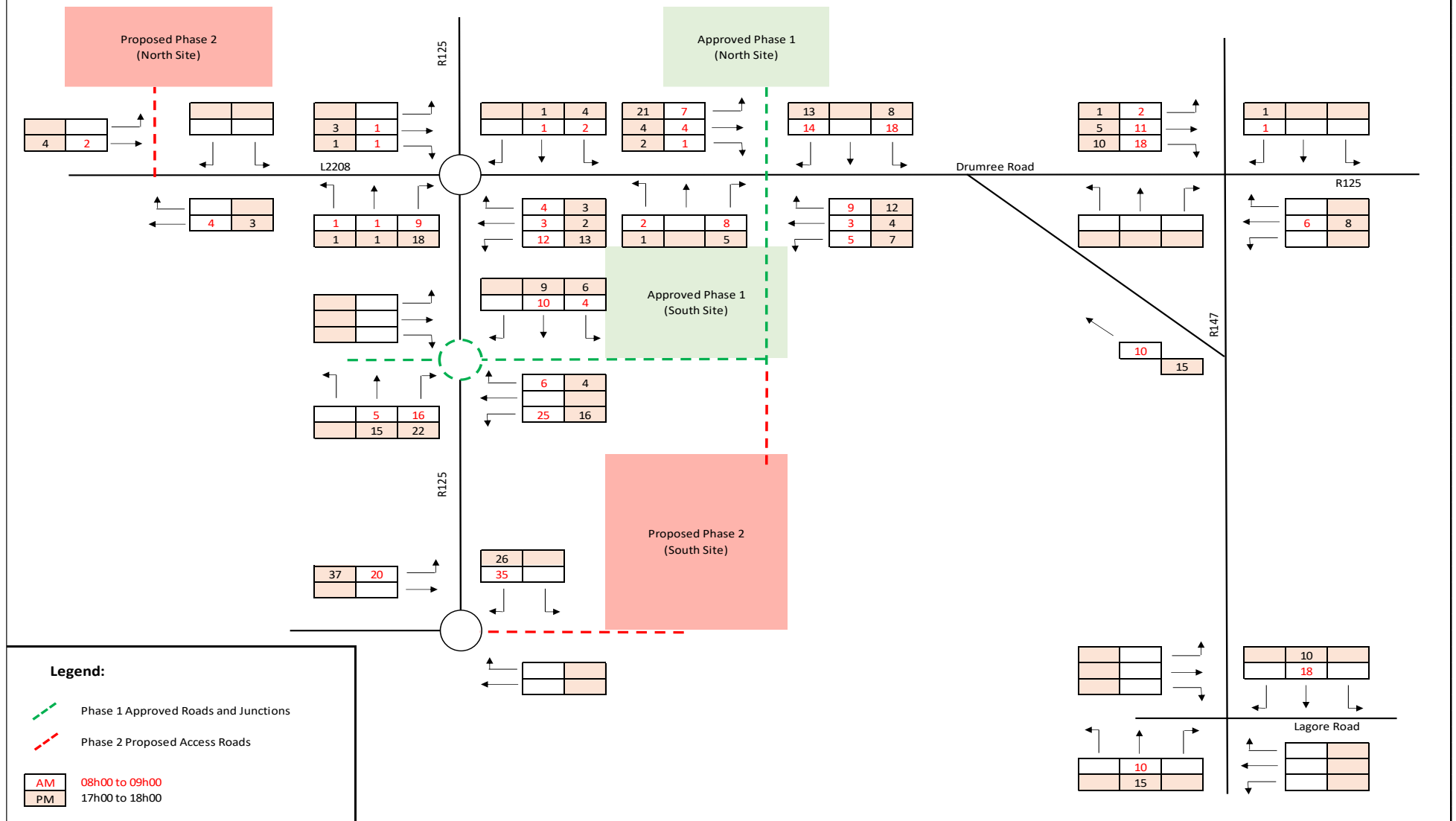

FIGURE H - TRIP DISTRIBUTION - POTENTIAL NEIGHBOURHOOD CENTRE

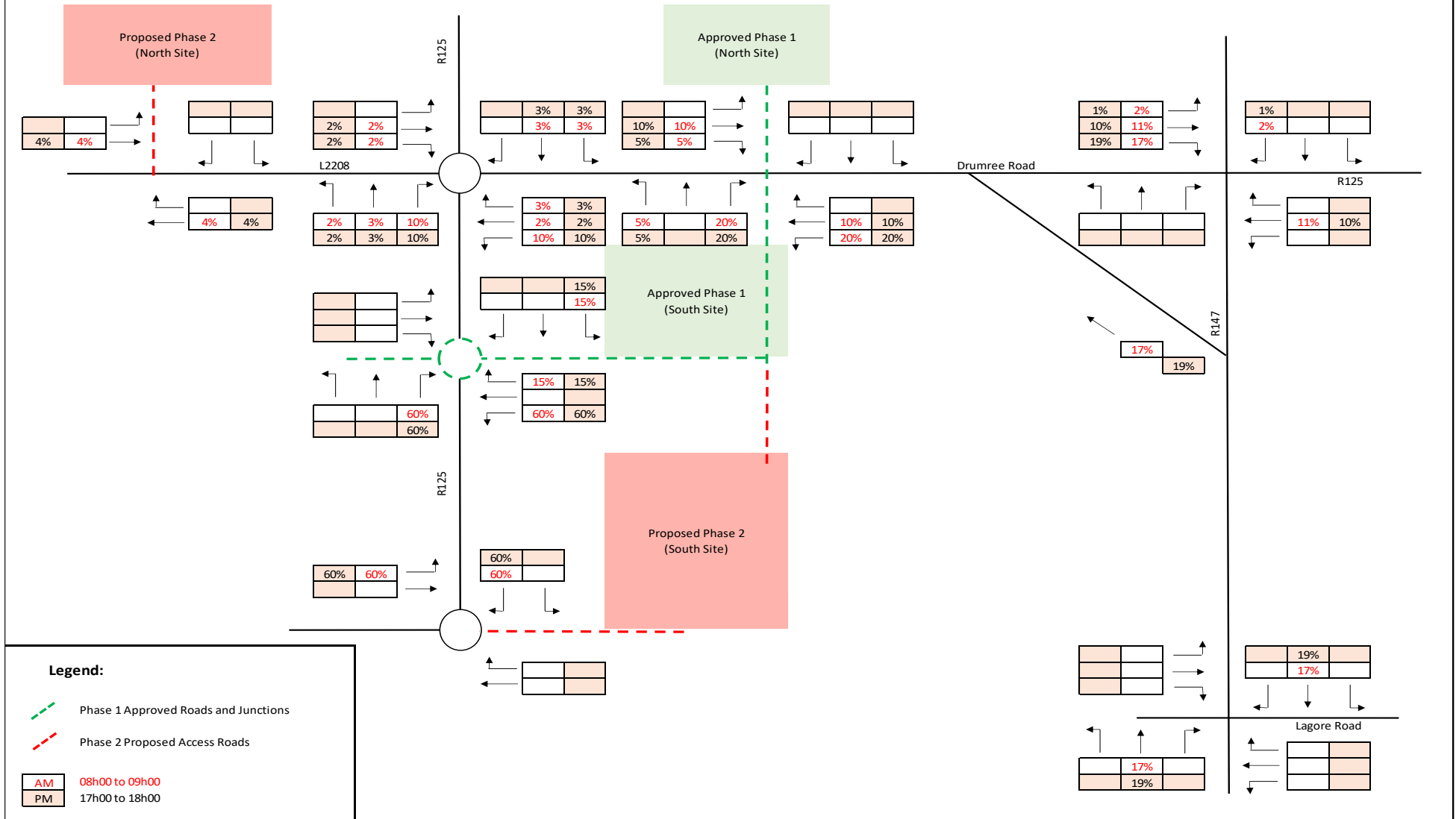

FIGURE I - TRIP ASSIGNMENT - POTENTIAL NEIGHBOURHOOD CENTRE

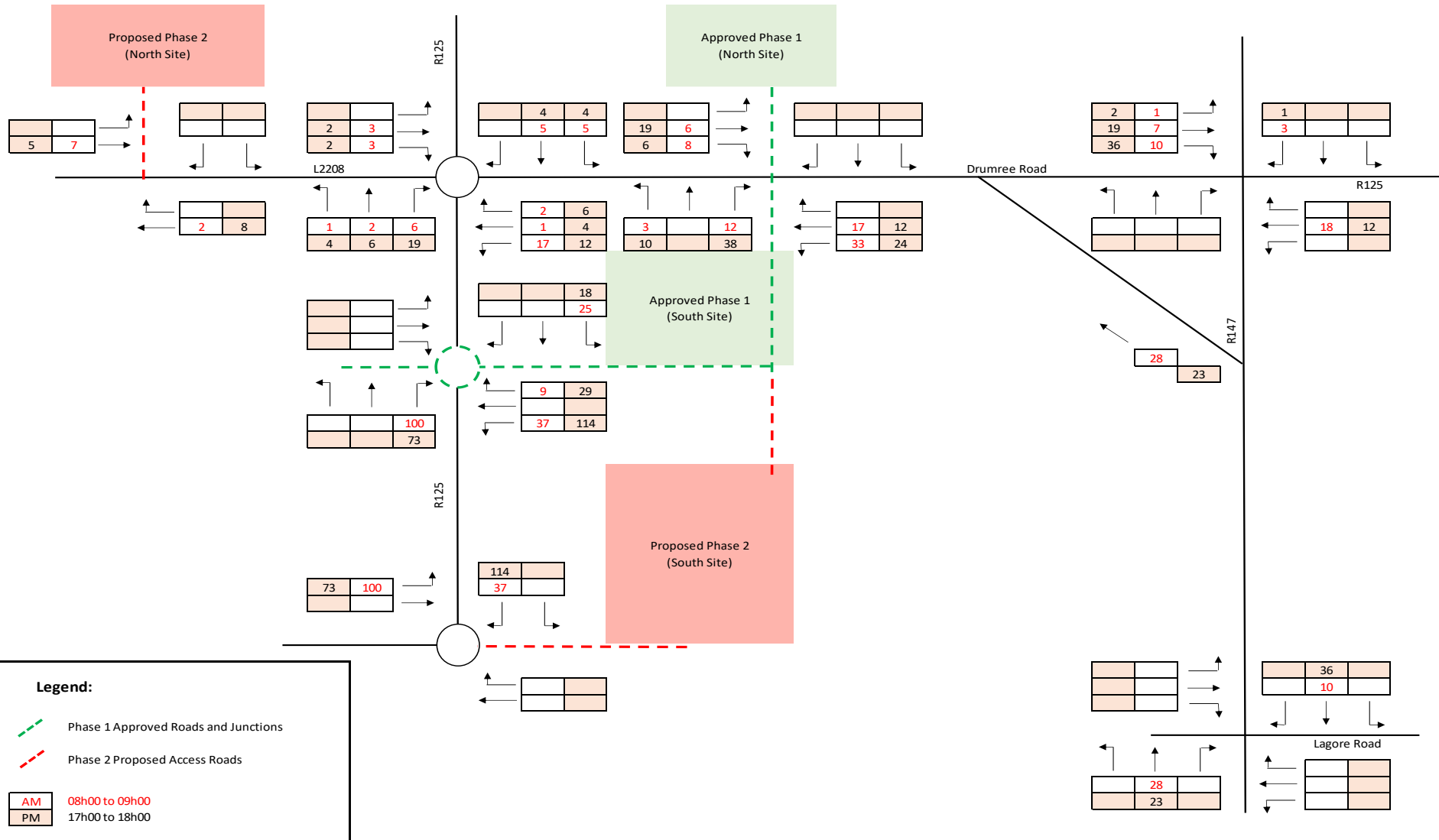
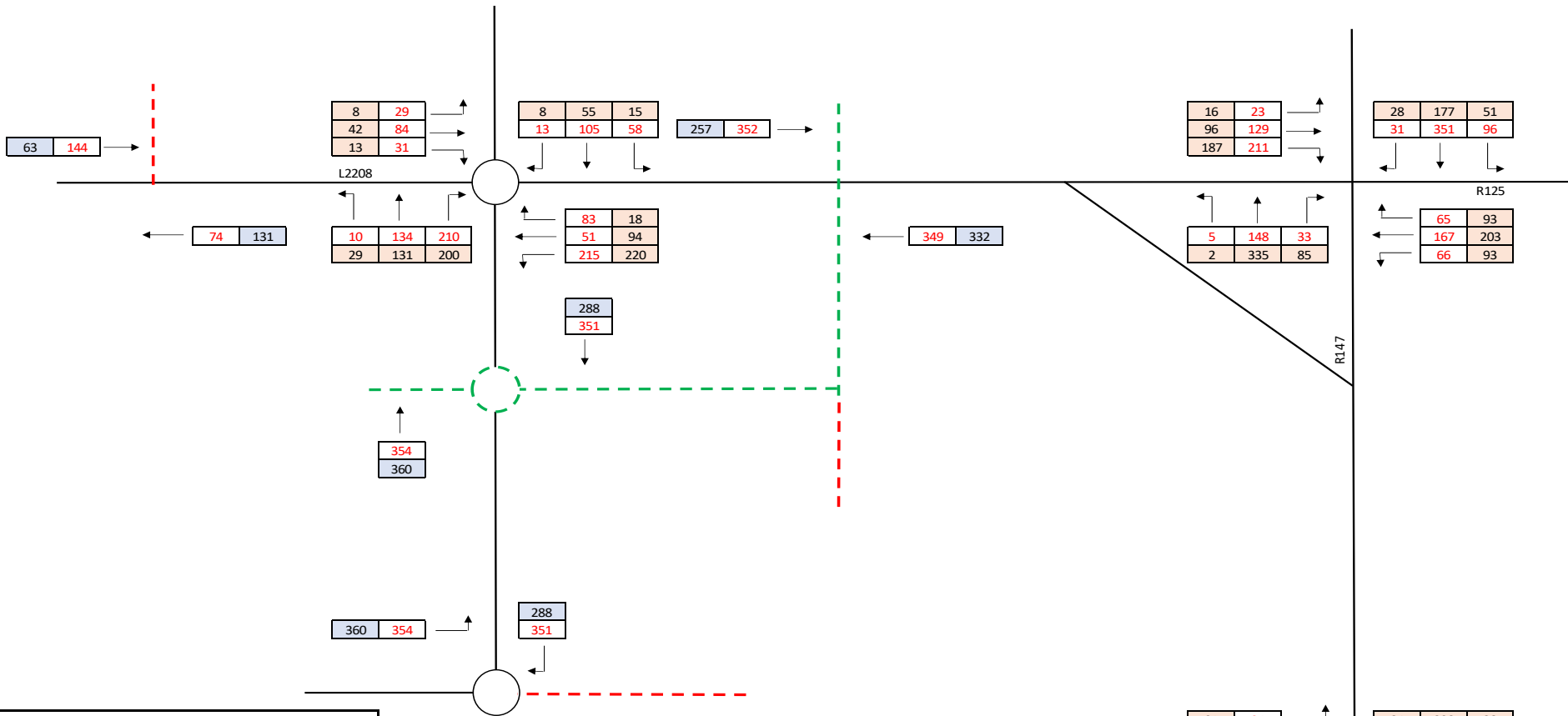

FIGURE J - 2020 SURVEYED AND EXPANDED FLOWS



Legend:

- Phase 1 Approved Roads and Junctions
- Phase 2 Access Roads

Surveyed Flows		Expanded Flows	
AM	08h00 to 09h00	AM	08h00 to 09h00
PM	17h00 to 18h00	PM	17h00 to 18h00

63	144
----	-----

74	131
----	-----

8	29
42	84
13	31

10	134	210
29	131	200

8	55	15
13	105	58

83	18
51	94
215	220

288
351

354
360

360	354
-----	-----

288
351

257	352
-----	-----

349	332
-----	-----

16	23
96	129
187	211

5	148	33
2	335	85

28	177	51
31	351	96

65	93
167	203
66	93

91	24
18	8
43	15

24	327	81
64	535	123

84	328	38
36	546	40

45	33
7	15
131	112

FIGURE K - 2024 DO NOTHING

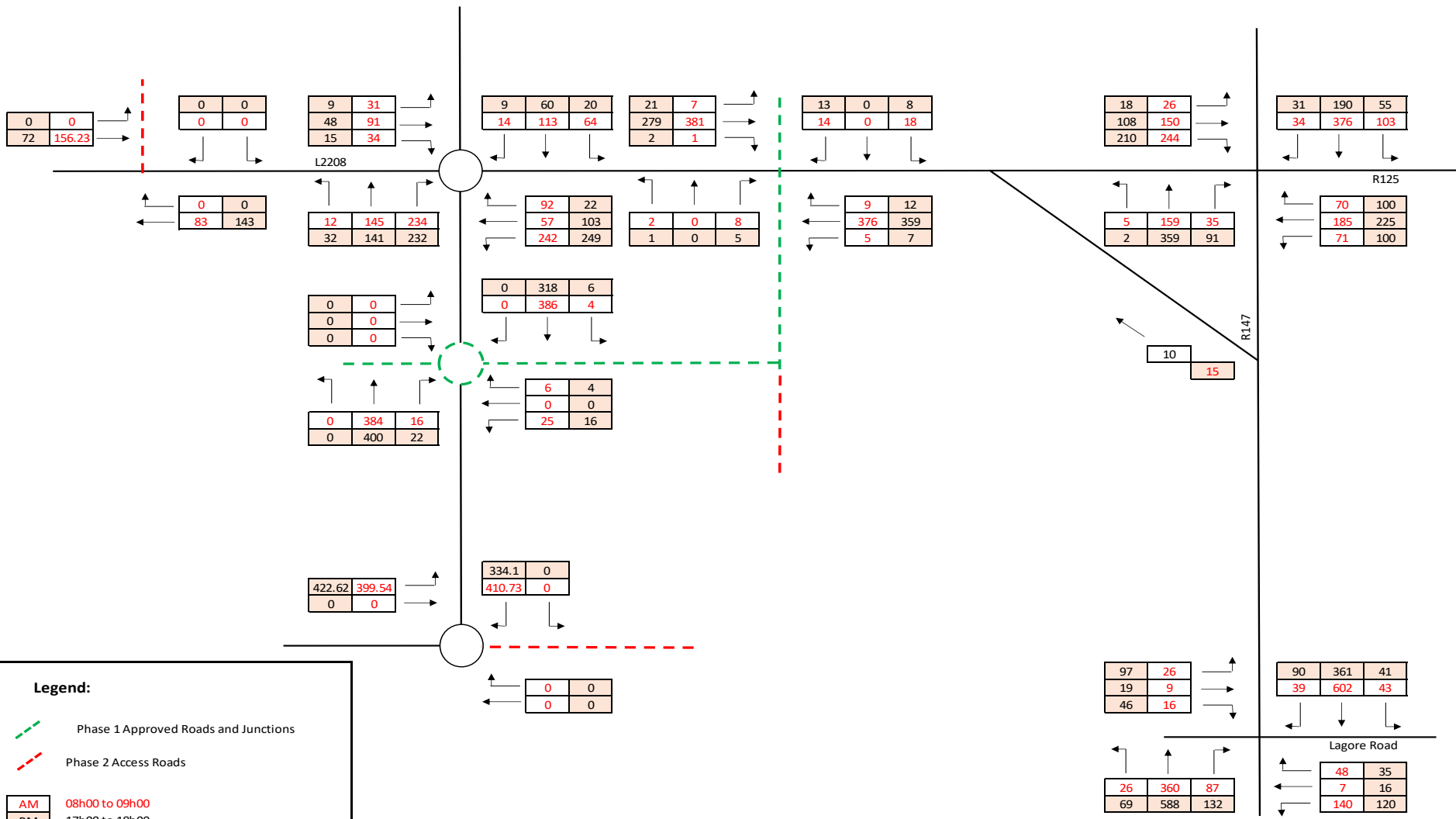

FIGURE L - 2029 DO NOTHING

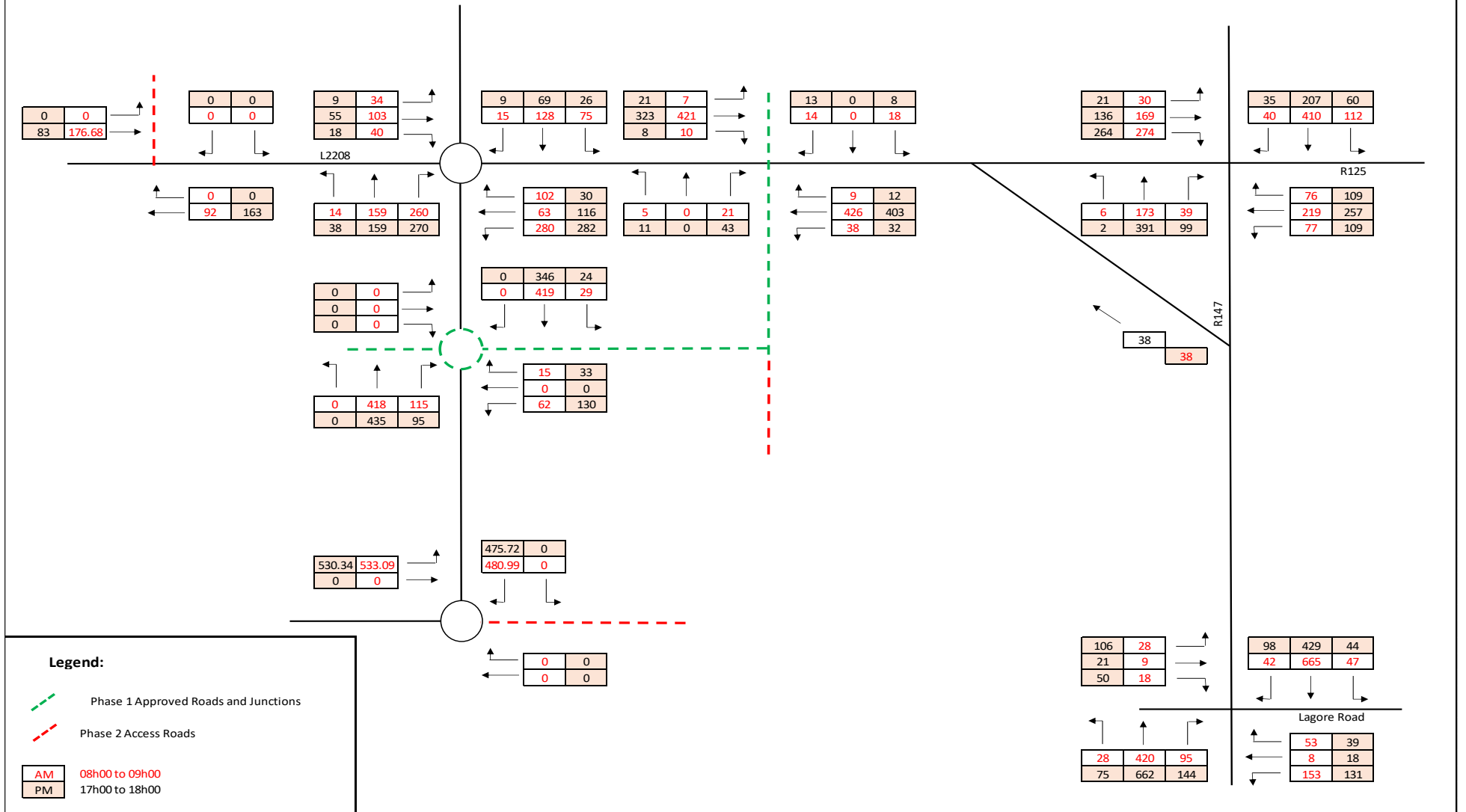

FIGURE M - 2039 DO NOTHING

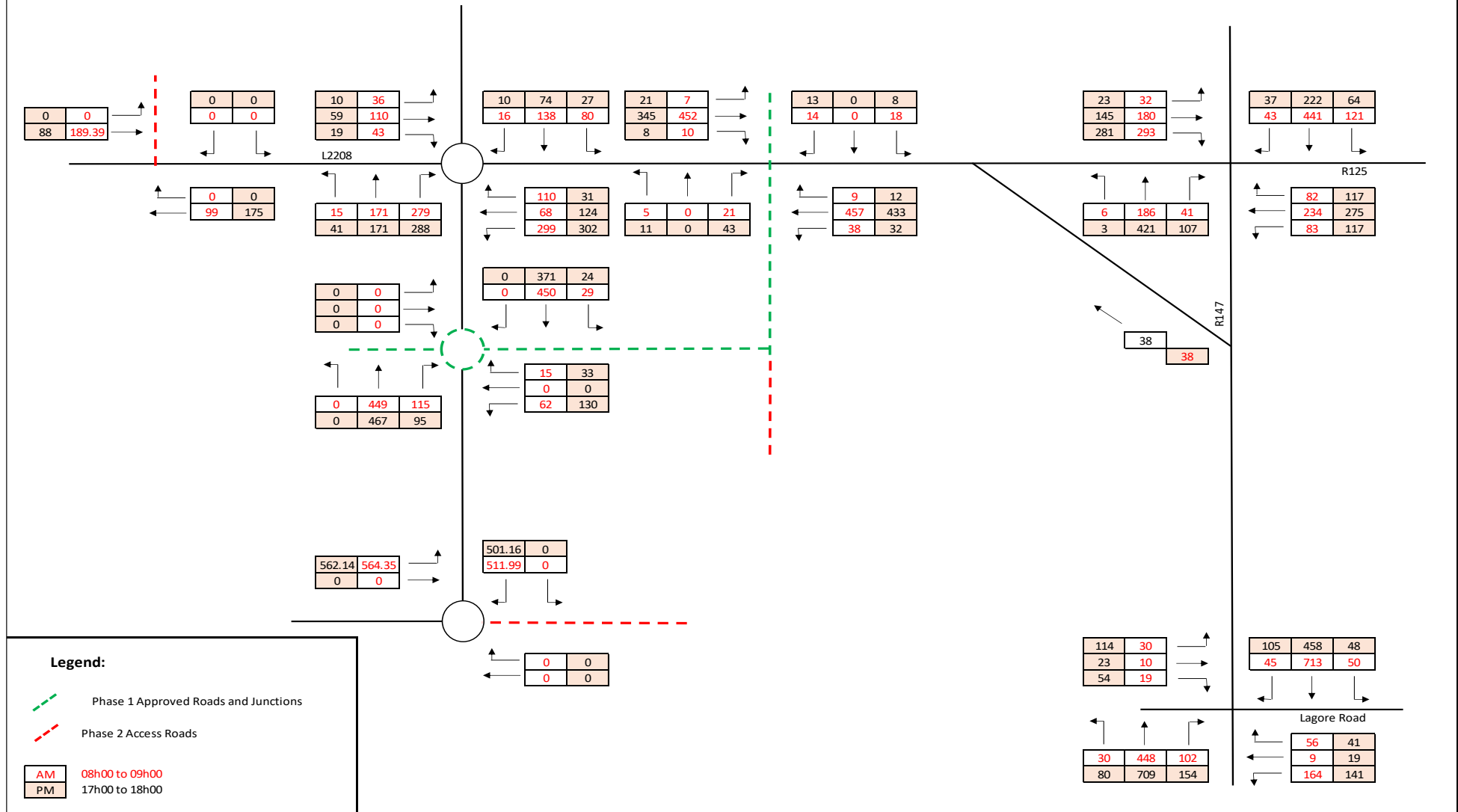

FIGURE N - 2024 DO SOMETHING

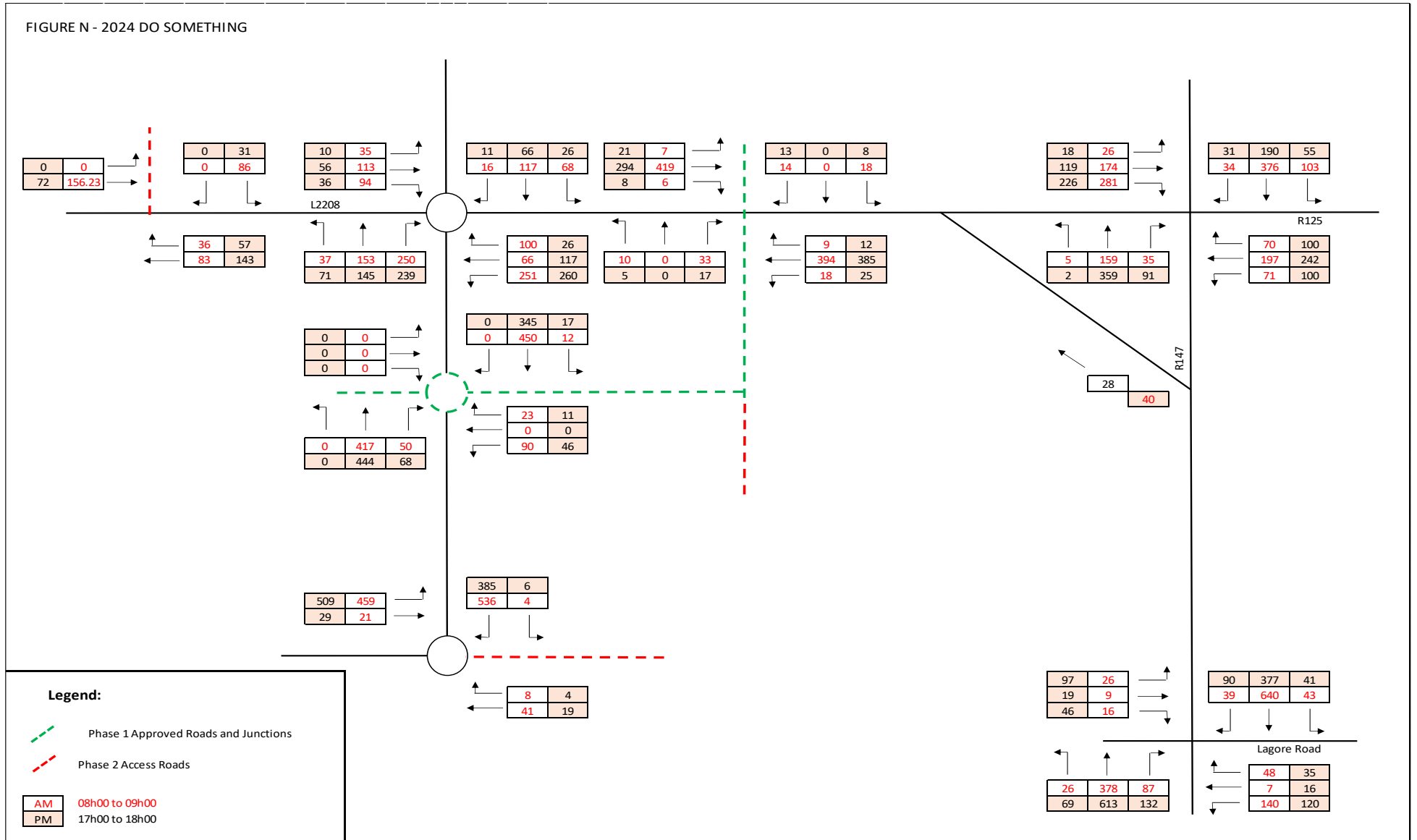

FIGURE O - 2029 DO SOMETHING

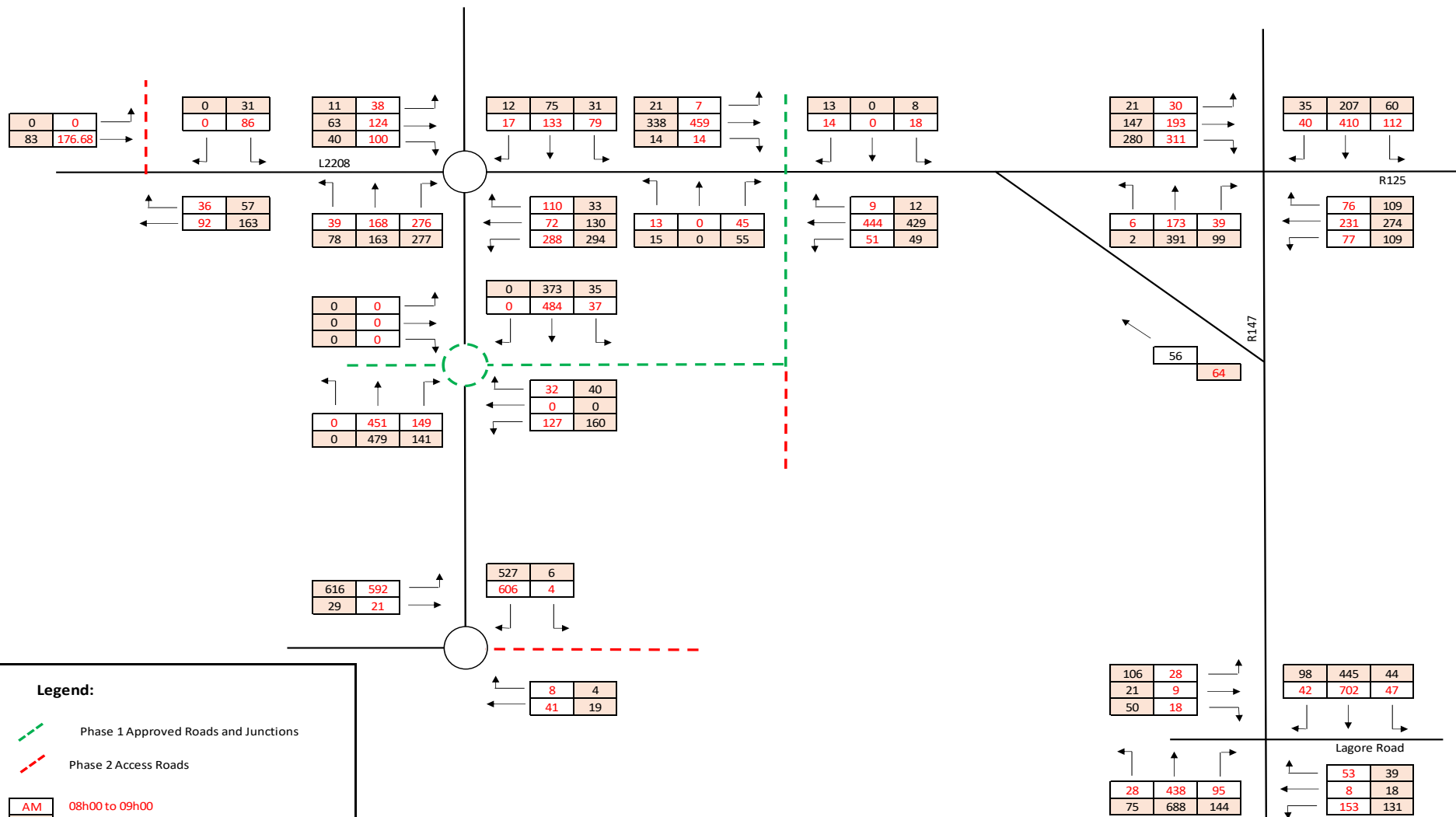
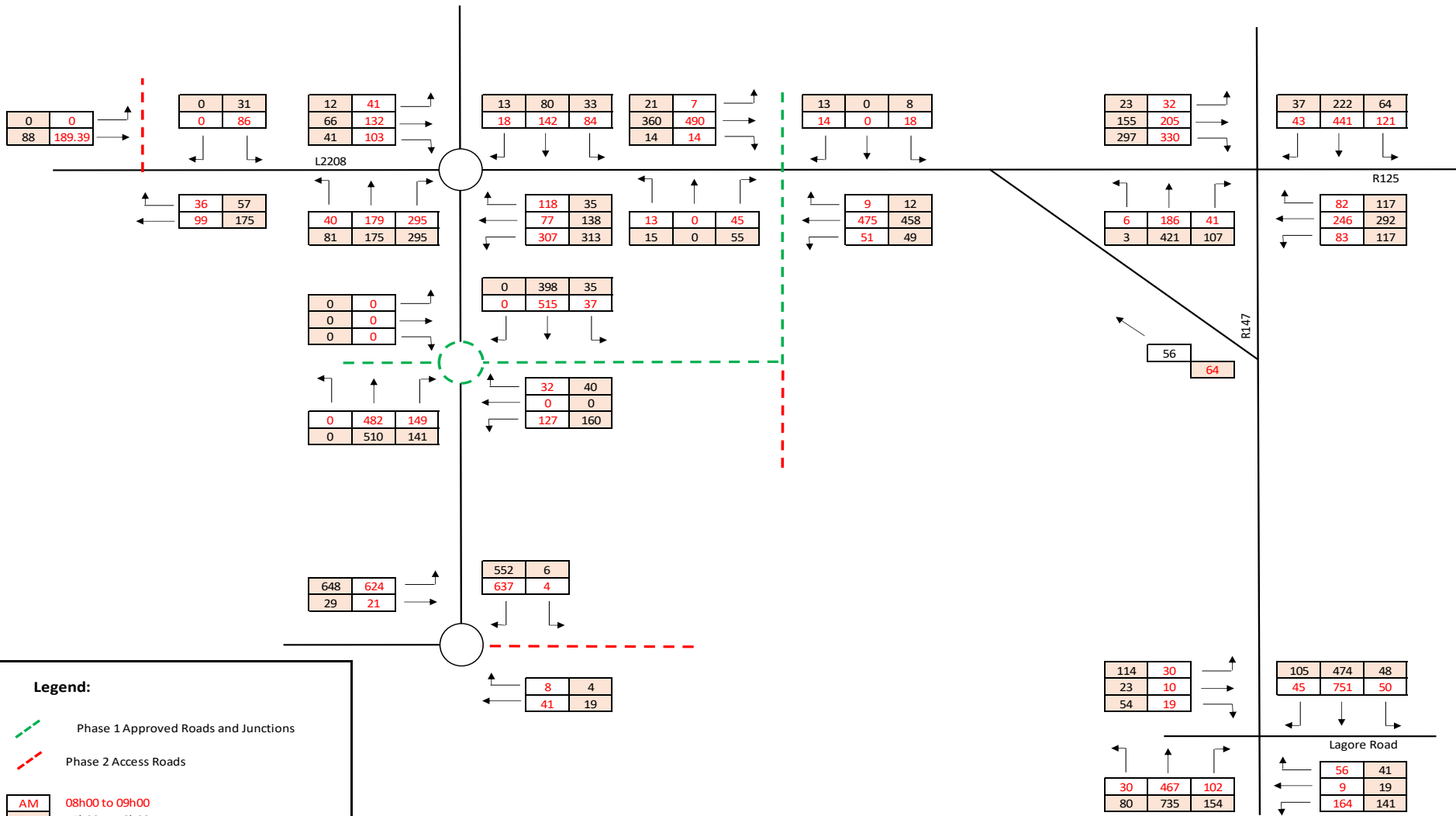

FIGURE P - 2039 DO SOMETHING



D. Junction Assessment – Layout Option 2

1. Layout Option 2

1.1 Introduction

This Appendix D of the subject Traffic and Transport Assessment has been prepared to assess the traffic impact expected to arise from an alternative site layout, labelled as Layout Option 2, and to establish the extent of this traffic impact over the DO NOTHING scenario when compared to the preferred Layout Option 1 (assessed in the body of the subject TTA).

Layout Option 2 comprises of a small change in the layout of the proposed South Site which consists of the downgrade of the vehicular connection link across F1 zoned lands to only allow pedestrian and cyclist movements across the Skane River. There are no other changes proposed to the Layout Option 2 as compared to the Layout Option 1. Number and location of the proposed units remain the same under both options.

1.2 Trip Generation

In order to assess the likely traffic impact arising from the proposed Layout Option 2 development, TRICS trip rates for Layout Option 1 presented in Table 2 – Section 6.1 of the subject TTA have been used. For ease of reference these trip rates are reproduced in Table D-1 below.

Land Use	Calculation Factor	AM Peak Hour (08h00 to 09h00)		PM Peak Hour (17h00 to 18h00)	
		Arr.	Dep.	Arr.	Dep.
Houses / Duplexes	per dwelling	0.295	0.674	0.432	0.253
Apartments	per dwelling	0.046	0.241	0.212	0.055
Creche	per 100sqm	5.946	3.271	3.766	5.055

Table D-1 | TRICS Trip Rates – AM and PM Peak Hours.

1.2.1 North Site

The proposed North Site, which has no changes proposed for Layout Option 2, will consist of 95 No. Houses, 20 No. Duplexes and 34 No. Apartments. As per Table 3 in Section 6.2.1 of the subject TTA, the proposed North Site, is expected to generate a total of 122 vehicle movements in the AM peak hour (36 arrivals and 86 departures) and a total of 88 vehicle movements in the PM peak hour (57 arrivals and 31 departures).

1.2.2 South Site

For the proposed Layout Option 2, the subject South Site will comprise the same number of units as presented for Layout Option 1, however the vehicular connection link across F1 zoned lands has been downgraded to only allow pedestrian and cyclist movements. As a result, the site has been separated into two portions with regards to vehicular access and movements, the South Site – North Portion and the South Site – South Portion. The calculated vehicular trips for both North and South Portions of the South Site is presented below.

South Site – North Portion

To the north of F1 zoned lands, the South Site – North Portion will comprise of 38 No. Apartments, 6 No. duplexes, 77 No. Houses and a Creche with 413sqm of area. The estimated car trip generation for the proposed South Site – North Portion is shown in Table D-2 below.

Land Use	No. Units / Floor Area	AM Peak Hour (08h00 to 09h00)		PM Peak Hour (17h00 to 18h00)	
		Arr.	Dep.	Arr.	Dep.
Houses / Duplexes	83 units	25	56	36	22
Apartments	38 units	2	9	8	2
Creche	413 sqm	25	14	16	21
Total	121 units 413 sqm	52	79	60	45

Table D-2 | AM&PM Car Trip Generation – South Site – North Portion – Layout Option 2.

As can be seen above, the proposed South Site – North Portion is expected to generate a total of 131 vehicle movements in the AM peak hour (52 arrivals and 79 departures) and a total of 105 vehicle movements in the PM peak hour (60 arrivals and 45 departures).

South Site – South Portion

To the south of F1 zoned lands, the South Site – South Portion will comprise of 34 No. Apartments, 6 No. duplexes and 105 No. Houses. The estimated car trip generation for the proposed South Site – South Portion is shown in Table D-3 below.

Land Use	No. Units / Floor Area	AM Peak Hour (08h00 to 09h00)		PM Peak Hour (17h00 to 18h00)	
		Arr.	Dep.	Arr.	Dep.
Houses / Duplexes	111 units	33	75	48	29
Apartments	34 units	2	8	7	2
Total	145 units	35	83	55	31

Table D-3 | AM&PM Car Trip Generation – South Site – South Portion – Layout Option 2.

As can be seen above, the proposed South Site – South Portion is expected to generate a total of 118 vehicle movements in the AM peak hour (35 arrivals and 83 departures) and a total of 86 vehicle movements in the PM peak hour (55 arrivals and 31 departures).

1.3 Trip Distribution

1.3.1 North Site

Trip distribution to/from the proposed North Site, which has no changes proposed for Layout Option 2, was kept the same as presented in Section 7.1.1 of the subject TTA, which is:

- 25% to/from Dunshaughlin Town Centre (W), of which

- 15% to/from south along R147, and
- 10% to/from east along R125 Ratoath Road.
- 5% via R125 Dunshaughlin Link Road (N) to/from Navan.
- 55% via R125 Dunshaughlin Link Road (S) to/from M3 Motorway, of which
 - 40% south to/from M3 Parkway Rail Station and Dublin City.
 - 15% north to/from Navan.
- 15% via R125 Dunshaughlin Link Road (S) to/from Trim via the bridge over M3 Motorway.

The trip distribution and assignment of the proposed North Site development's vehicular traffic across the local road network are illustrated in Figure A and Figure B, respectively, as included in Appendix C.

1.3.2 South Site

Trip distribution of the estimated traffic to/from the proposed South Site – North and South Portions, presented in Tables D-2 and D-3 above respectively, are presented below.

South Site – North Portion

For Layout Option 2, vehicular access to the South Site – North Portion will be provided from north via the following access:

Access Point 1: Southern arm of the under-construction signalised junction on Drumree Road – approved under Phase 1 development.

Access Point 2: Eastern arm of the new roundabout on R125 Dunshaughlin Link Road – approved under Phase 1 development.

Access Point 1, which will be accessed via the under-construction Phase 1 development, is assumed to serve 25% of the overall vehicular trips estimated for the South Site – North Portion, whilst Access Point 2 will serve 75% of the trips.

South Site – South Portion

For Layout Option 2, the only vehicular access to the South Site – South Portion will be provided from southwest via the proposed eastern arm of the proposed three-armed roundabout on R125 Dunshaughlin Link Road.

In summary, the trip distribution for the proposed South Site – North and South Portions was assumed as follows:

- 25% to/from Dunshaughlin Town Centre, of which
 - 15% to/from south along R147, and
 - 10% to/from east along R125 Ratoath Road.
- 10% via R125 Dunshaughlin Link Road (N) to/from Navan and major employments.
- 50% via R125 Dunshaughlin Link Road (S) to/from M3 Motorway, of which
 - 40% south to/from M3 Parkway Rail Station and Dublin City, and
 - 10% north to/from Navan and major employments.

- 15% via R125 Dunshaughlin Link Road (S) to/from Trim and major employments via the bridge over M3 Motorway.

The trip distribution and assignment of the proposed South Site – North Portion development’s vehicular traffic across the local road network are illustrated below in Figure D-1 and Figure D-2, respectively.

The trip distribution and assignment of the proposed South Site – South Portion development’s vehicular traffic across the local road network are illustrated below in Figure D-3 and Figure D-4, respectively.

Forecast traffic movements from/to the overall proposed development for Layout Option 2, including South Site - North and South Portions and North Site, is illustrated in Figure D-5 below. The trip assignment of the proposed North Site development’s vehicular traffic across the local road network is illustrated in Appendix C - Figure B.

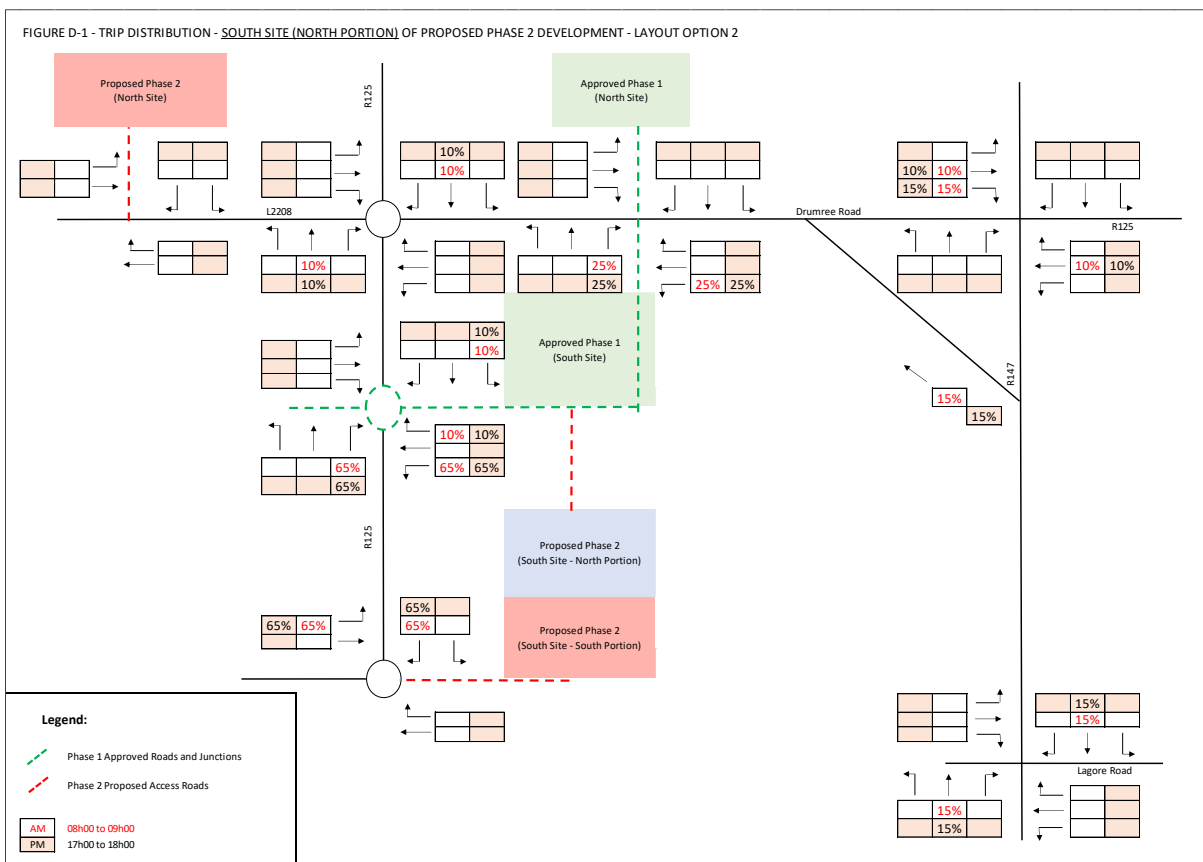

Figure D-1 | Trip Distribution – South Site – North Portion – Layout Option 2.

FIGURE D-2 - TRIP ASSIGNMENT - SOUTH SITE (NORTH PORTION) OF PROPOSED PHASE 2 DEVELOPMENT - LAYOUT OPTION

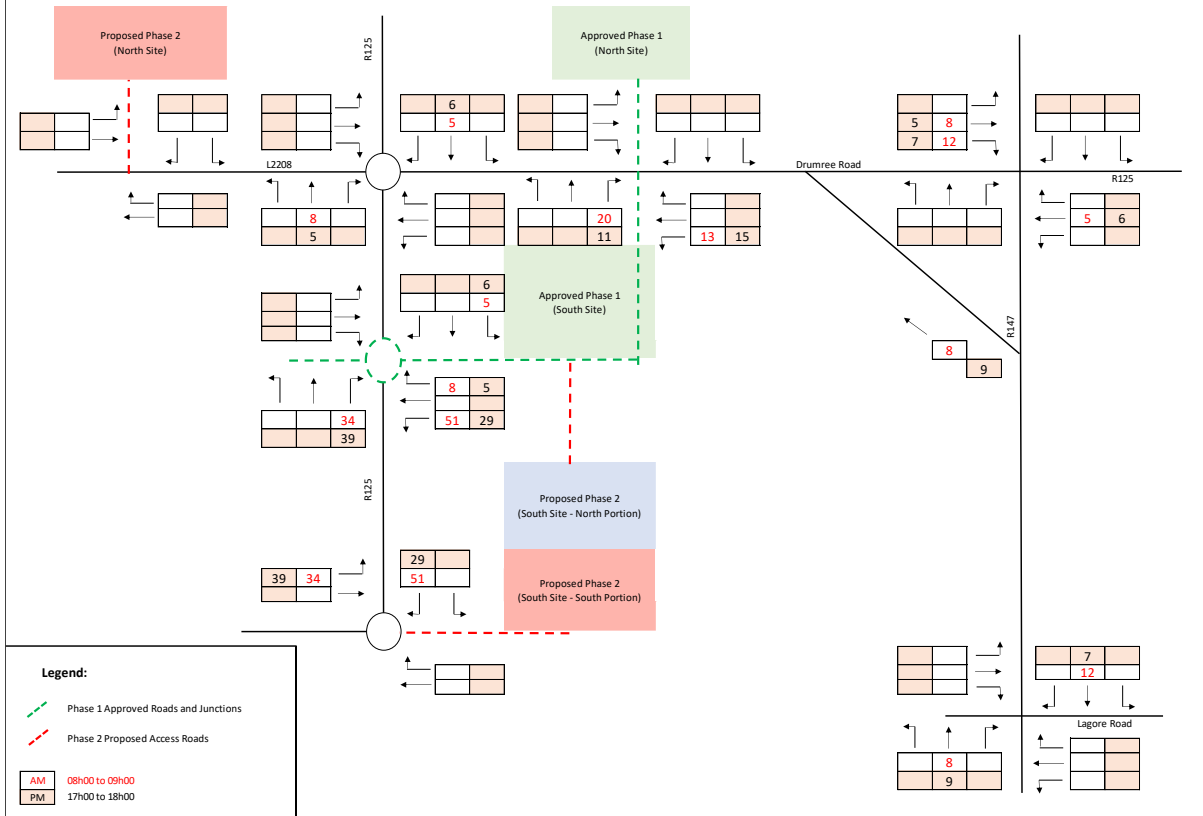

Figure D-2 | Trip Assignment – South Site – North Portion – Layout Option 2.

FIGURE D-3 - TRIP DISTRIBUTION - SOUTH SITE (SOUTH PORTION) OF PROPOSED PHASE 2 DEVELOPMENT - LAYOUT OPTION 2

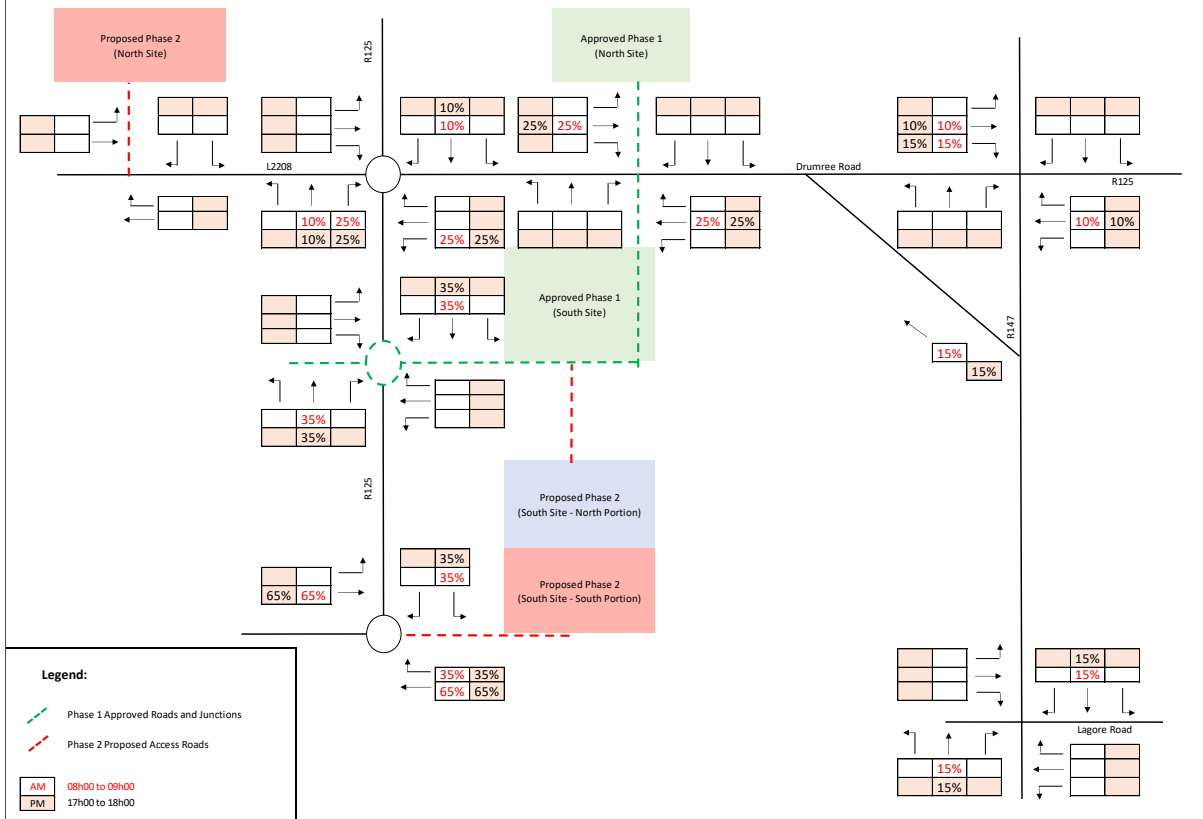

Figure D-3 | Trip Distribution – South Site – South Portion – Layout Option 2.

FIGURE D-4 - TRIP ASSIGNMENT - SOUTH SITE (SOUTH PORTION) OF PROPOSED PHASE 2 DEVELOPMENT - LAYOUT OPTION 2

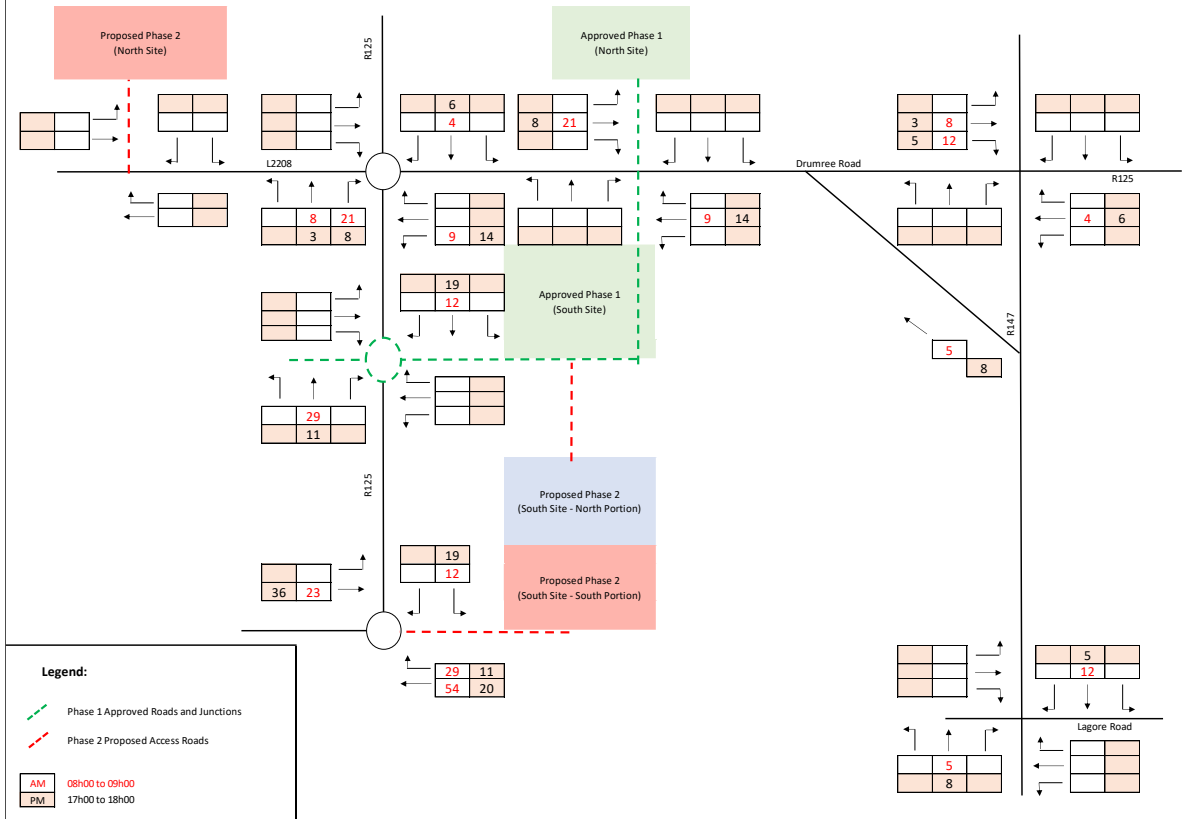

Figure D-4 | Trip Assignment – South Site – South Portion – Layout Option 2.

FIGURE D-5 - TRIP GENERATION - PROPOSED PHASE 2 DEVELOPMENT NORTH AND SOUTH SITES - LAYOUT OPTION 2

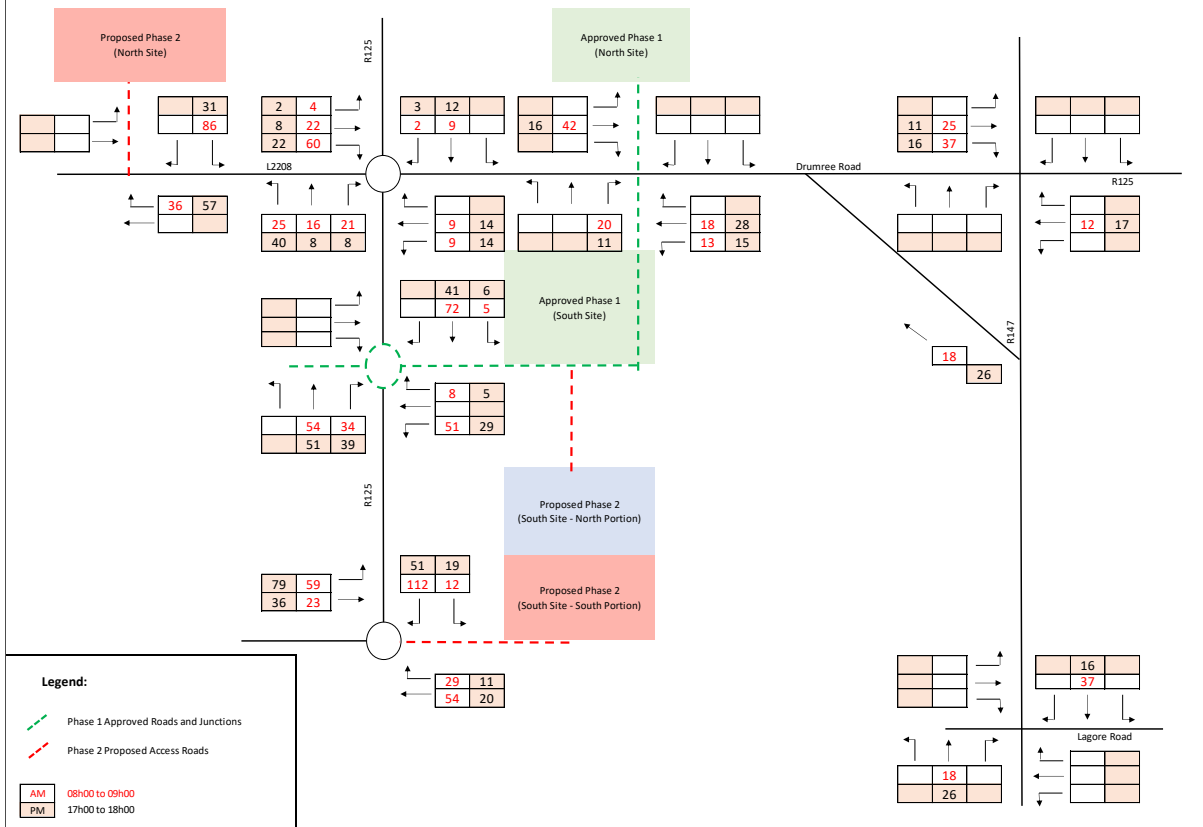

Figure D-5 | Forecast Traffic – South Site – North and South Portion + North Site – Layout Option 2.

1.4 Junction Assessment

1.4.1 Modelled Junctions and Assessed Scenarios

For the purpose of assessing the traffic impact arising from the Layout Option 2, the performance of Junctions 3, 4, 5 and 7 have been modelled for the DO SOMETHING scenario in the future assessment year of 2039 (worst-case scenario). Then, the results have been compared to 2039 DO NOTHING and 2039 DO SOMETHING (Layout Option 1) scenarios presented in Section 9.4 of the subject TTA. The proposed change under the Layout Option 2 will not affect Junctions 1, 2 and 6 when compared to Layout Option 1, and therefore no further assessment of these junctions has been undertaken.

A summary of the modelled junctions and assessed scenarios is presented below.

Modelled Junctions

- **Junction 3 (Existing Priority-controlled Roundabout):** R125 / L2208 / Drumree Road.
- **Junction 4 (Approved Signalised Crossroads):** Drumree Road / Access Roads to Phase 1.
- **Junction 5 (Approved Priority-controlled Roundabout):** R125 / Access Road to Phase 1 and Phase 2 South Site – North Portion.
- **Junction 7 (Proposed Upgraded Roundabout):** R125 / Access Road to Phase 2 South Site – North Portion.

Junction 1, Junction 2 and Junction 6 have not been further modelled in the subject assessment for Layout Option 2, for the reason that there will be no difference in the number of car trips traveling through these junctions when compared to the DO SOMETHING Layout Option 1. Therefore, the junction analysis results for Junctions 1, 2 and 6 would be exactly the same.

Assessed Scenarios

- **DO NOTHING – 2039:** Approved junctions on the road network with 2020 baseline traffic flows factored up + traffic to/from the under-construction Phase 1 development + traffic to/from the potential Neighbourhood Centre. For this scenario the surveyed and approved Junctions 3, 4 and 5 have been modelled. (Refer to Figure M – Appendix C).
- **DO SOMETHING – 2039 (Layout Option 1):** Proposed and approved junctions on the road network with 2020 baseline traffic flows factored up + traffic to/from the under-construction Phase 1 development + traffic to/from the potential Neighbourhood Centre + traffic to/from the proposed Phase 2 development **with the vehicular connection link across F1 zoned lands in place**. For this scenario the surveyed, approved and proposed Junctions 3, 4, 5 and 7 have been modelled. (Refer to Figure P – Appendix C).
- **DO SOMETHING – 2039 (Layout Option 2):** Proposed and approved junctions on the road network with 2020 baseline traffic flows factored up + traffic to/from the under-construction Phase 1 development + traffic to/from the potential Neighbourhood Centre + traffic to/from the proposed Phase 2 development **without the vehicular connection link across F1 zoned lands**. For this scenario the surveyed, approved and proposed Junctions 3, 4, 5 and 7 have been modelled (Refer to Figure D-6 below).

FIGURE D-6 - 2039 DO SOMETHING (Layout Option 2)

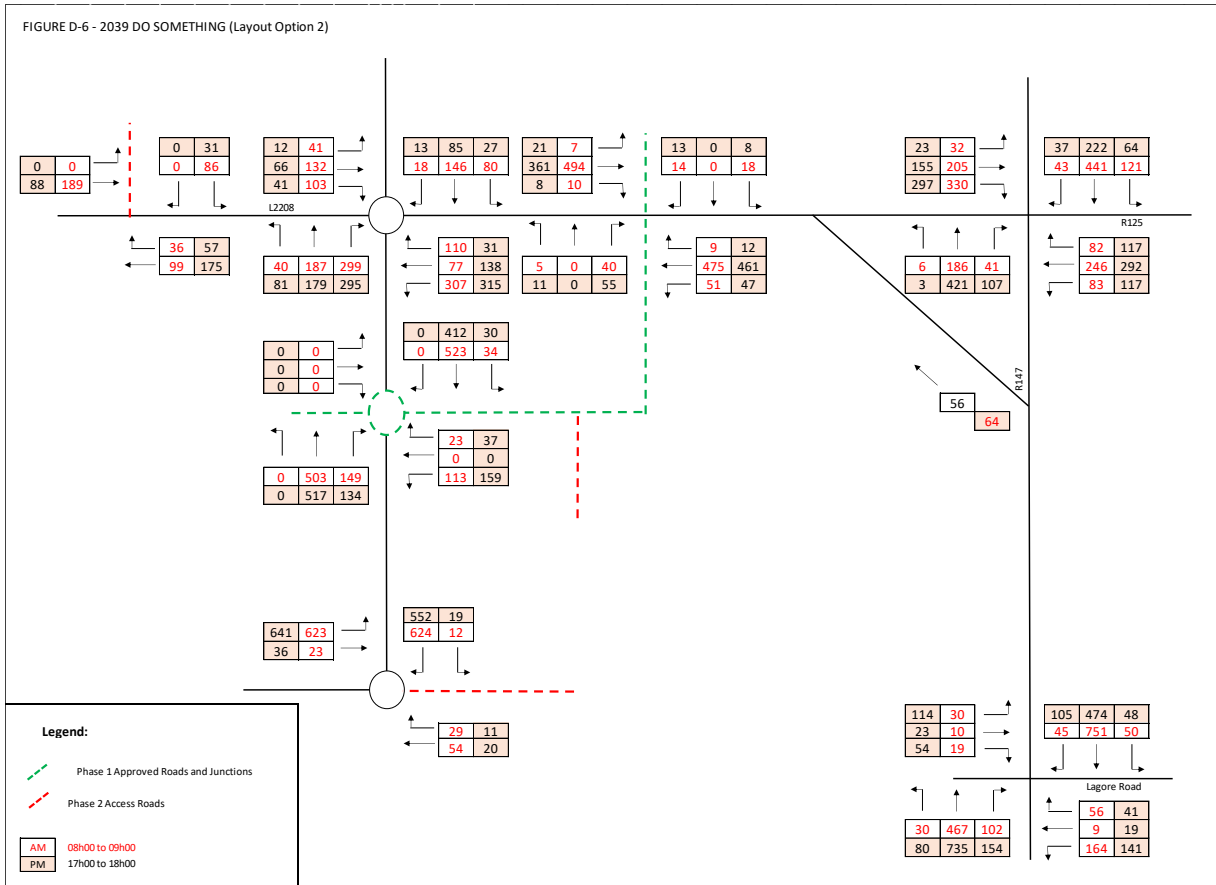

Figure D-6 | Forecast Traffic – DO SOMETHING - 2039 (Layout Option 2).

1.4.2 Junction Assessment Results

Junction 3

Junction 3 is an existing four-armed roundabout located southeast of the proposed North Site of Phase 2. The ARCADY analysis results for each assessed scenario is summarised in Table D-4 below. The arms of the roundabout were labelled as follows within the ARCADY model:

- Arm 1: Drumree Road (E);
- Arm 2: R125 (S);
- Arm 3: L2208 (W);
- Arm 4: R125 (N).

DO NOTHING - 2039				
Arm	AM		PM	
	RFC	Queue (Veh)	RFC	Queue (Veh)
Arm 1	0.41	0.7	0.37	0.6
Arm 2	0.34	0.5	0.36	0.6
Arm 3	0.19	0.2	0.08	0.1
Arm 4	0.19	0.2	0.09	0.1
DO SOMETHING – 2039 (Layout Option 1)				
Arm	AM		PM	
	RFC	Queue (Veh)	RFC	Queue (Veh)
Arm 1	0.44	0.8	0.40	0.7
Arm 2	0.37	0.6	0.39	0.7

Arm 3	0.28	0.4	0.11	0.1
Arm 4	0.20	0.3	0.10	0.1
DO SOMETHING – 2039 (Layout Option 2)				
Arm	AM		PM	
	RFC	Queue (Veh)	RFC	Queue (Veh)
Arm 1	0.43	0.8	0.40	0.7
Arm 2	0.38	0.6	0.40	0.7
Arm 3	0.29	0.4	0.11	0.1
Arm 4	0.21	0.3	0.10	0.1

Table D-4 | Junction 3 – ARCADY Analysis Results Comparison.

As can be seen from the above, for the DO SOMETHING – 2039 (Layout Option 2) scenario, Junction 3 would continue to operate well within capacity during both peak hours, with the highest RFC at 0.43 and a corresponding queue of 0.8 vehicle recorded on Drumree Road (E) in the AM peak hour, and with the highest RFC at 0.40 and a corresponding queue of 0.7 vehicle recorded on Drumree Road (E) and R125 (S) in the PM peak hour. When compared to Layout Option 1, it is noted that the differences in the recorded RFC's and queue lengths values of each arm of the junction is minimal.

Junction 4

Junction 4 is an approved (under-construction) signalised junction located on Drumree Road to the north of the proposed South Site. The TRANSYT analysis results for each assessed scenario is summarised in Table D-7 below. The arms of the junction were labelled as follows within the TRANSYT model:

- Arm A: Drumree Road (E);
- Arm B: Phase 1 Site Access Road (S);
- Arm C: Drumree Road (W);
- Arm D: Phase 1 Site Access Road (N).

DO NOTHING - 2039					
Arm	Movement	AM		PM	
		DOS%	Queue (Veh)	DOS%	Queue (Veh)
A	S/L/R	78	16.20	66	13.50
B	S/L/R	29	0.89	51	2.00
C	S/L	78	15.15	70	11.56
	R	2	0.23	2	0.19
D	S/L/R	36	1.13	35	0.77
DO SOMETHING – 2039 (Layout Option 1)					
Arm	Movement	AM		PM	
		DOS%	Queue (Veh)	DOS%	Queue (Veh)
A	S/L/R	83	18.12	72	15.48
B	S/L/R	64	2.43	52	2.51
C	S/L	85	17.57	75	12.61
	R	2	0.32	3	0.33
D	S/L/R	36	1.13	47	0.88
DO SOMETHING – 2039 (Layout Option 2)					
Arm	Movement	AM		PM	
		DOS%	Queue (Veh)	DOS%	Queue (Veh)
A	S/L/R	83	18.12	71	15.14
B	S/L/R	50	1.69	55	2.45
C	S/L	86	17.96	75	12.65

	R	2	0.23	2	0.19
D	S/L/R	36	1.13	47	0.88

Table D-5 | Junction 4 – TRANSYT Analysis Results Comparison.

As can be seen from the above, for the DO SOMETHING – 2039 (Layout Option 2) scenario, Junction 4 would continue to operate within capacity during both peak hours, with the highest DOS at 86% and a corresponding queue of 17.96 vehicles recorded on Drumree Road (W) in the AM peak hour, and with the highest DOS at 75% and a corresponding queue of 12.65 vehicles also recorded on Drumree Road (W) in the PM peak hour. When compared to Layout Option 1, it is noted that the differences in the recorded DOS's and queue lengths values of each arm of the junction is minimal.

Junction 5

Junction 5 is an approved four-armed roundabout to be located immediately northwest of the proposed South Site of Phase 2. The ARCADY analysis results for each assessed scenario is summarised in Table D-6 below. The arms of the roundabout were labelled as follows within the ARCADY model:

- Arm 1: Phase 1 Site Access Road (E);
- Arm 2: R125 (S);
- Arm 3: Minor Access Road (W);
- Arm 4: R125 (N).

DO NOTHING - 2039				
Arm	AM		PM	
	RFC	Queue (Veh)	RFC	Queue (Veh)
Arm 1	0.06	0.1	0.12	0.1
Arm 2	0.31	0.5	0.31	0.5
Arm 3	0.00	0.0	0.00	0.0
Arm 4	0.28	0.4	0.23	0.3
DO SOMETHING – 2039 (Layout Option 1)				
Arm	AM		PM	
	RFC	Queue (Veh)	RFC	Queue (Veh)
Arm 1	0.12	0.1	0.14	0.2
Arm 2	0.35	0.5	0.36	0.6
Arm 3	0.00	0.0	0.00	0.0
Arm 4	0.33	0.5	0.26	0.3
DO SOMETHING – 2039 (Layout Option 2)				
Arm	AM		PM	
	RFC	Queue (Veh)	RFC	Queue (Veh)
Arm 1	0.10	0.1	0.14	0.2
Arm 2	0.36	0.6	0.36	0.6
Arm 3	0.00	0.0	0.00	0.0
Arm 4	0.33	0.5	0.26	0.4

Table D-6 | Junction 5 – ARCADY Analysis Results Comparison.

As can be seen from the above, for the DO SOMETHING – 2039 (Layout Option 2) scenario, Junction 5 would continue to operate well within capacity during both peak hours, with the highest RFC at 0.36 and a corresponding queue of 0.6 vehicle recorded on R125 (S) in the AM peak hour, and with the highest RFC at 0.36 and a corresponding queue of 0.6 vehicle also recorded on R125 (S) in the PM peak hour. When compared to Layout Option 1, it is noted that the differences in the recorded RFC's and queue length values of each arm of the junction is minimal.

Junction 7

Junction 7 is an existing two-armed roundabout located immediately southwest of the proposed South Site – South Portion, which is proposed to be upgraded to a three-armed roundabout with the eastern arm forming the Site Access Road to South Site – South Portion. The ARCADY analysis results for each assessed scenario is summarised in Table D-7 below. The arms of the roundabout were labelled as follows within the ARCADY model:

- Arm 1: Access Road to South Site – South Portion (E);
- Arm 2: R125 (W);
- Arm 3: R125 (N).

DO SOMETHING – 2039 (Layout Option 1)				
Arm	AM		PM	
	RFC	Queue (Veh)	RFC	Queue (Veh)
Arm 1	0.04	0.0	0.02	0.0
Arm 2	0.41	0.7	0.43	0.7
Arm 3	0.44	0.8	0.38	0.6
DO SOMETHING – 2039 (Layout Option 2)				
Arm	AM		PM	
	RFC	Queue (Veh)	RFC	Queue (Veh)
Arm 1	0.06	0.1	0.02	0.0
Arm 2	0.41	0.7	0.43	0.8
Arm 3	0.43	0.8	0.39	0.6

Table D-7 | Junction 7 – ARCADY Analysis Results Comparison.

As can be seen from the above, for the DO SOMETHING – 2039 (Layout Option 2) scenario, Junction 7 would continue to operate well within capacity during both AM and PM peak hours, with the highest RFC at 0.36 and a corresponding queue of 0.6 vehicle recorded on R125 (W) in the AM peak hour, and with the highest RFC at 0.36 and a corresponding queue of 0.6 vehicle also recorded on R125 (S) in the PM peak hour. When compared to Layout Option 1, it is noted that the differences in the recorded RFC's and queue length values of each arm of the junction is minimal.

E. ARCADY, PICADY and TRANSYT Output Reports

TRANSYT 15
Version: 15.5.2.7994 © Copyright TRL Limited, 2018
For sales and distribution information, program advice and maintenance, contact TRL: +44 (0)1344 379777 software@trl.co.uk www.trisoftware.co.uk
The users of this computer program for the solution of an engineering problem are in no way relieved of their responsibility for the correctness of the solution

Filename: Junction 1 - AM.t15

Path: M:\Projects\12\12-081A - Dunshaughlin Phase 2 - Civils\Design\Traffic\Modelling AUGUST 2020\Junction 1

Report generation date: 19/08/2020 12:04:57

- »A1 - DO NOTHING 2020 : D1 - DO NOTHING 2020* :
- »A2 - DO NOTHING 2024 : D2 - DO NOTHING 2024* :
- »A3 - DO NOTHING 2029 : D3 - DO NOTHING 2029* :
- »A4 - DO NOTHING 2039 : D4 - DO NOTHING 2039* :
- »A5 - DO SOMETHING 2024 : D5 - DO SOMETHING 2024* :
- »A6 - DO SOMETHING 2029 : D6 - DO SOMETHING 2029* :
- »A7 - DO SOMETHING 2039 : D7 - DO SOMETHING 2039* :

File summary

File description

File title	(untitled)
Location	
Site number	
UTCRegion	
Driving side	Left
Date	06/12/2011
Version	
Status	(new file)
Identifier	
Client	
Jobnumber	
Enumerator	DOMAINf.silva
Description	

Model and Results

Enable controller offsets	Enable fuel consumption	Enable quick flares	Display journey time results	Display level of service results	Display blocking and starvation results	Display end of red and green queue results	Display excess queue results	Display separate uniform and random results	Display unweighted results	Display TRANSYT 12 style timings	Display effective greens in results	Display Red-With-Amber	Display End-Of-Green Amber
			✓		✓		✓	✓					

Units

Cost units	Speed units	Distance units	Fuel economy units	Fuel rate units	Mass units	Traffic units input	Traffic units results	Flow units	Average delay units	Total delay units	Rate of delay units
£	kph	m	mpg	l/h	kg	Veh	Veh	perHour	s	-Hour	perHour

Sorting

Show names instead of IDs	Sorting direction	Sorting type	Ignore prefixes when sorting	Analysis/demand set sorting	Link grouping	Source grouping	Colour Analysis/Demand Sets
	Ascending	Numerical		ID	Normal	Normal	✓

A1 - DO NOTHING 2020

D1 - DO NOTHING 2020*

Summary

Data Errors and Warnings

No errors or warnings

Run Summary

Analysis set used	Run start time	Run finish time	Modelling start time (HH:mm)	Network Cycle Time (s)	Performance Index (£ per hr)	Total network delay (Veh-hr/hr)	Highest DOS (%)	Item with highest DOS	Number of oversaturated items	Percentage of oversaturated items (%)	Item with worst signalised PRC	Item with worst unsignalised PRC	Item with worst over PR
1	19/08/2020 12:04:14	19/08/2020 12:04:15	08:00	120	340.91	22.95	70.33	C/2	0	0	C/2	Dx/1	C/

Analysis Set Details

Name	Description	Demand set	Include in report	Locked
DO NOTHING 2020		D1	✓	

Demand Set Details

Name	Description	Composite	Demand sets	Start time (HH:mm)	Locked
DO NOTHING 2020				08:00	

Arms and Traffic Streams

Arms

Arm	Name	Description	Traffic node
A	(untitled)		1
Ax	(untitled)		
B	(untitled)		1
Bx	(untitled)		
C	(untitled)		1
Cx	(untitled)		
D	(untitled)		1
Dx	(untitled)		
9			1
10			1
11			1
12			1

Traffic Streams

Arm	Traffic Stream	Name	Description	Auto length	Length (m)	Has Saturation Flow	Saturation flow source	Saturation flow (PCU/hr)	Is signal controlled	Is give way	Traffic type	Allow Nearside Turn On Red
A	1	(untitled)			20.00	✓	Sum of lanes	1800	✓		Normal	
	2				200.00	✓	Sum of lanes	1800	✓		Normal	
Ax	1	(untitled)		✓	182.93						Normal	
B	1	(untitled)			200.00	✓	Sum of lanes	1800	✓		Normal	
	2				18.00	✓	Sum of lanes	1800	✓		Normal	
Bx	1	(untitled)		✓	178.44						Normal	
C	1	(untitled)			200.00	✓	Sum of lanes	1800	✓		Normal	
	2				40.00	✓	Sum of lanes	1800	✓		Normal	
Cx	1	(untitled)		✓	194.82						Normal	
D	1	(untitled)			200.00	✓	Sum of lanes	1800	✓		Normal	
	2				30.00	✓	Sum of lanes	1800	✓		Normal	
Dx	1	(untitled)		✓	177.04						Normal	
9	1			✓	48.53						Normal	
10	1			✓	31.46						Normal	
11	1			✓	37.01						Normal	
12	1			✓	34.36						Normal	

Lanes

Arm	Traffic Stream	Lane	Name	Description	Use RR67	Saturation flow (PCU/hr)
A	1	1	(untitled)			1800
	2	1	(untitled)			1800
Ax	1	1	(untitled)			
B	1	1	(untitled)			1800
	2	1	(untitled)			1800
Bx	1	1	(untitled)			
C	1	1	(untitled)			1800
	2	1	(untitled)			1800
Cx	1	1	(untitled)			
D	1	1	(untitled)			1800
	2	1	(untitled)			1800
Dx	1	1	(untitled)			
9	1	1	(untitled)			
10	1	1	(untitled)			
11	1	1	(untitled)			
12	1	1	(untitled)			

Modelling

Arm	Traffic Stream	Traffic model	Stop weighting multiplier (%)	Delay weighting multiplier (%)	Assignment Cost Weighting (%)	Exclude from results calculation	Max queue storage (PCU)	Has queue limit	Has degree of saturation limit
(ALL)	(ALL)	NetworkDefault	100	100	100		0.00		

Modelling - Advanced

Arm	Traffic Stream	Initial queue (PCU)	Type of Vehicle-in-Service	Vehicle-in-Service	Type of random parameter	Random parameter	Auto cycle time	Cycle time
(ALL)	(ALL)	0.00	NetworkDefault	Not-Included	NetworkDefault	0.50	✓	120

Normal traffic - Modelling

Arm	Traffic Stream	Stop weighting (%)	Delay weighting (%)
(ALL)	(ALL)	100	100

Normal traffic - Advanced

Arm	Traffic Stream	Dispersion type for Normal Traffic
(ALL)	(ALL)	NetworkDefault

Flows

Arm	Traffic Stream	Total Flow (Veh/hr)	Normal Flow (Veh/hr)
A	1	233	233
	2	65	65
Ax	1	258	258
B	1	153	153
	2	33	33
Bx	1	628	628
C	1	152	152
	2	211	211
Cx	1	203	203
D	1	447	447
	2	31	31
Dx	1	236	236
9	1	298	298
10	1	186	186
11	1	363	363
12	1	478	478

Signals

Arm	Traffic Stream	Controller stream	Phase	Second phase enabled
A	1	1	D	
	2	1	C	
B	1	1	B	
	2	1	A	
C	1	1	D	
	2	1	C	
D	1	1	B	
	2	1	A	

Pedestrian Crossings

Pedestrian Crossings

Crossing	Name	Description	Traffic node	Allow walk on red	Crossing type	Length (m)	Cruise time (seconds)	Cruise speed (kph)
1	(untitled)		1		Farside	7.00	4.67	5.40
2	(untitled)		1		Farside	8.00	5.33	5.40
3	(untitled)		1		Farside	8.00	5.33	5.40
4	(untitled)		1		Farside	7.00	4.67	5.40

Pedestrian Crossings - Signals

Crossing	Controller stream	Phase	Second phase enabled
(ALL)	1	E	

Pedestrian Crossings - Sides

Crossing	Side	Saturation flow (Ped/hr)
(ALL)	(ALL)	11000

Pedestrian Crossings - Modelling

Crossing	Side	Delay weighting (%)	Assignment Cost Weighting (%)	Exclude from results calculation	Max queue storage (Ped)	Has queue limit	Has degree of saturation limit
(ALL)	(ALL)	100	100		0.00		

Local OD Matrix - Local Matrix: 1

Local Matrix Options

OD Matrix	Name	Use for point to point table	Auto calculate	Allocation mode	Allow paths past exit locations	Allow looped paths on arms	Allow looped paths on traffic nodes	Copy flows	Matrix to copy flows from	Limit paths by length	Path length limit multiplier	Limit paths by number	Path number limit
1	(untitled)	✓	✓	Path Equalisation	✓		✓			✓	1.25		

Normal Input Flows (Veh/hr)

	To							
	1	2	3	4	5	6	7	8
From 1	0	23	129	211	0	0	0	0
From 2	31	0	96	351	0	0	0	0
From 3	167	65	0	66	0	0	0	0
From 4	5	148	33	0	0	0	0	0
From 5	0	0	0	0	0	0	0	0
From 6	0	0	0	0	0	0	0	0
From 7	0	0	0	0	0	0	0	0
From 8	0	0	0	0	0	0	0	0

Bus Input Flows not shown as they are blank.

Tram Input Flows not shown as they are blank.

Pedestrian Input Flows (Veh/hr)

	To							
	1	2	3	4	5	6	7	8
From 1	0	0	0	0	0	0	0	0
From 2	0	0	0	0	0	0	0	0
From 3	0	0	0	0	0	0	0	0
From 4	0	0	0	0	0	0	0	0
From 5	0	0	0	0	0	50	50	0
From 6	0	0	0	0	50	0	0	50
From 7	0	0	0	0	50	0	0	50
From 8	0	0	0	0	0	50	50	0

Locations

OD Matrix	Location	Name	Entries	Exits	Colour
1	1	(untitled)	11/1	Cx/1	#0000FF
	2	(untitled)	12/1	Dx/1	#FF0000
	3	(untitled)	9/1	Ax/1	#00FF00
	4	(untitled)	10/1	Bx/1	#FFFF00
	5	(untitled)	3:2E, 1:1E	3:2X, 1:1X	#FF00FF
	6	(untitled)	2:1E, 1:2E	2:1X, 1:2X	#008000
	7	(untitled)	4:2E, 3:1E	4:2X, 3:1X	#FFA500
	8	(untitled)	4:1E, 2:2E	4:1X, 2:2X	#00FFFF

Normal Paths and Flows

OD Matrix	Path	Description	From location	To location	Path items	Allocation type	Normal Calculated Flow (Veh/hr)
1	9		4	3	10/1, B/2, Ax/1	Normal	33
	10		3	4	9/1, A/1, Bx/1	Normal	66
	11		1	3	11/1, C/1, Ax/1	Normal	129
	12		1	4	11/1, C/2, Bx/1	Normal	211
	13		3	1	9/1, A/1, Cx/1	Normal	167
	14		4	1	10/1, B/1, Cx/1	Normal	5
	15		2	3	12/1, D/1, Ax/1	Normal	96
	16		2	4	12/1, D/1, Bx/1	Normal	351
	19		3	2	9/1, A/2, Dx/1	Normal	65
	20		4	2	10/1, B/1, Dx/1	Normal	148
	43		2	1	12/1, D/2, Cx/1	Normal	31
	44		1	2	11/1, C/1, Dx/1	Normal	23

Pedestrian Paths and Flows

OD Matrix	Path	Description	From location	To location	Path items	Allocation type	Pedestrian calculated flow (Ped/hr)
1	17		8	7	4:1E, 4:2X	Normal	50
	18		8	6	2:2E, 2:1X	Normal	50
	22		5	7	3:2E, 3:1X	Normal	50
	23		5	6	1:1E, 1:2X	Normal	50
	34		6	8	2:1E, 2:2X	Normal	50
	35		6	5	1:2E, 1:1X	Normal	50
	41		7	8	4:2E, 4:1X	Normal	50
	42		7	5	3:1E, 3:2X	Normal	50

Signal Timings

Network Default: 120s cycle time; 120 steps

Controller Stream 1

Controller Stream	Name	Description	Use sequence	Cycle time source	Cycle time (s)
1	(untitled)		1	NetworkDefault	120

Controller Stream 1 - Properties

Controller Stream	Manufacturer name	Type	Model number	(Telephone) Line Number	Site number	Grid reference	Gaining delay type
1	Unspecified						Relative

Controller Stream 1 - Optimisation

Controller Stream	Allow offset optimisation	Allow green split optimisation	Optimisation level	Auto redistribute	Enable stage constraint
1	✓	✓	Offsets And Green Splits	✓	

Phases

Controller Stream	Phase	Name	Minimum green (s)	Maximum green (s)	Relative start displacement (s)	Relative end displacement (s)	Type	Blackout Time (s)
1	A	(untitled)	5	70	0	0	Traffic	
	B	(untitled)	7	70	0	0	Traffic	
	C	(untitled)	7	70	0	0	Traffic	
	D	(untitled)	7	70	0	0	Traffic	
	E	(untitled)	5	5	0	0	Pedestrian	0

Library Stages

Controller Stream	Library Stage	Phases in stage	User stage minimum (s)
1	1	A	1
	2	B	1
	3	C	1
	4	D	1
	5	E	1

Stage Sequences

Controller Stream	Sequence	Name	Multiple cycling	Stage IDs	Stage ends
1	1	(untitled)	Single	1, 2, 3, 4, 5	114, 43, 67, 94, 104

Intergreen Matrix for Controller Stream 1

		To				
		A	B	C	D	E
From	A		5	5	5	5
	B	5		5	5	5
	C	5	5		5	5
	D	5	5	5		5
	E	5	5	5	5	

Banned Stage transitions for Controller Stream 1

		To				
		1	2	3	4	5
From	1					
	2					
	3					
	4					
	5					

Interstage Matrix for Controller Stream 1

		To				
		1	2	3	4	5
From	1	0	5	5	5	5
	2	5	0	5	5	5
	3	5	5	0	5	5
	4	5	5	5	0	5
	5	5	5	5	5	0

Resultant Stages

Controller Stream	Resultant Stage	Is base stage	Library Stage ID	Phases in this stage	Stage start (s)	Stage end (s)	Stage duration (s)	User stage minimum (s)	Stage minimum (s)
1	1	✓	1	A	109	114	5	1	5
	2	✓	2	B	119	43	44	1	7
	3	✓	3	C	48	67	19	1	7
	4	✓	4	D	72	94	22	1	7
	5	✓	5	E	99	104	5	1	5

Resultant Phase Green Periods

Controller Stream	Phase	Green period	Is base green period	Start time (s)	End time (s)	Duration (s)
1	A	1	✓	109	114	5
	B	1	✓	119	43	44
	C	1	✓	48	67	19
	D	1	✓	72	94	22
	E	1	✓	99	104	5

Traffic Stream Green Times

Arm	Traffic Stream	Traffic Node	Controller Stream	Phase	Green Period 1		
					Start	End	Duration
A	1	1	1	D	72	94	22
A	2	1	1	C	48	67	19
B	1	1	1	B	119	43	44
B	2	1	1	A	109	114	5
C	1	1	1	D	72	94	22
C	2	1	1	C	48	67	19
D	1	1	1	B	119	43	44
D	2	1	1	A	109	114	5

Phase Timings Diagram for Controller Stream 1

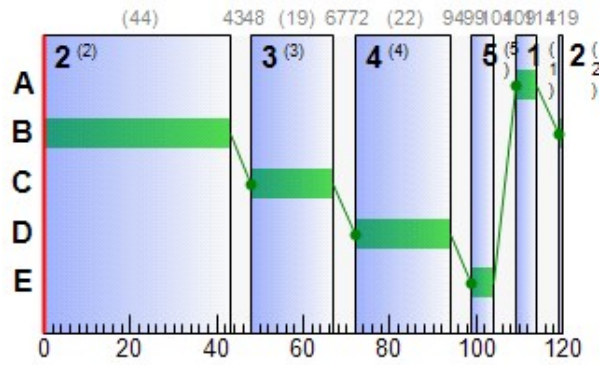

Stage Sequence Diagram for Controller Stream 1

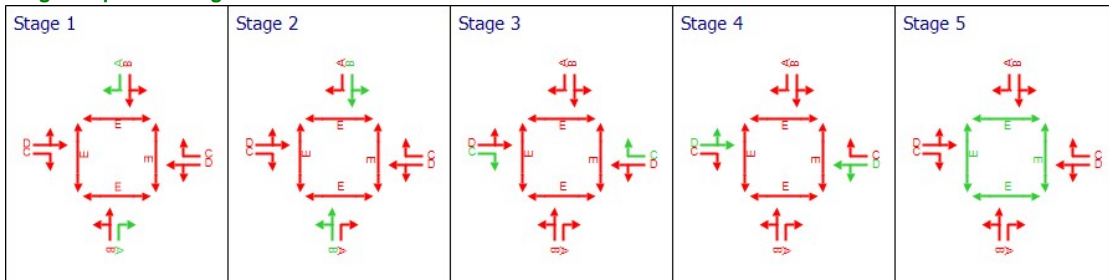

Resultant penalties

Time Segment	Controller stream	Phase min max penalty (£ per hr)	Intergreen broken penalty (£ per hr)	Stage constraint broken penalty (£ per hr)	Cost of controller stream penalties (£ per hr)
08:00-09:00	1	0.00	0.00	0.00	0.00

Traffic Stream Results

Traffic Stream Results: Vehicle summary

Time Segment	Arm	Traffic Stream	Degree of saturation (%)	Practical reserve capacity (%)	Calculated flow entering (Veh/hr)	Calculated sat flow (Veh/hr)	Actual green (s per cycle)	Mean Delay per Veh (s)	Mean max queue (Veh)	Utilised storage (%)	Weighted cost of delay (£ per hr)	Weighted cost of stops (£ per hr)	Performance Index (£ per hr)	
08:00-09:00	A	1	68	48	233	1800	22	55.64	7.87	226.26	51.13	2.92	54.05	
		2	22	362	65	1800	19	44.90	1.89	5.43	11.51	0.70	12.22	
	Ax	1	0	Unrestricted	258	Unrestricted	120	0.00	0.00	0.00	0.00	0.00	0.00	0.00
		2	0	Unrestricted	258	Unrestricted	120	0.00	0.00	0.00	0.00	0.00	0.00	0.00
	B	1	23	341	153	1800	44	26.40	3.48	9.99	15.93	1.29	17.22	
		2	37	173	33	1800	5	66.58	1.17	37.30	8.67	0.43	9.10	
	Bx	1	0	Unrestricted	628	Unrestricted	120	0.00	0.00	0.00	0.00	0.00	0.00	0.00
		2	0	Unrestricted	628	Unrestricted	120	0.00	0.00	0.00	0.00	0.00	0.00	0.00
	C	1	44	127	152	1800	22	46.91	4.61	13.24	28.12	1.71	29.84	
		2	70	42	211	1800	19	60.96	7.43	106.80	50.74	2.75	53.49	
	Cx	1	0	Unrestricted	203	Unrestricted	120	0.00	0.00	0.00	0.00	0.00	0.00	0.00
		2	0	Unrestricted	203	Unrestricted	120	0.00	0.00	0.00	0.00	0.00	0.00	0.00
	D	1	66	51	447	1800	44	36.35	12.93	37.19	64.09	4.79	68.89	
		2	34	190	31	1800	5	65.46	1.08	20.69	8.00	0.40	8.41	
Dx	1	0	Unrestricted	236	Unrestricted	120	0.00	0.00	0.00	0.00	0.00	0.00	0.00	
	2	0	Unrestricted	236	Unrestricted	120	0.00	0.00	0.00	0.00	0.00	0.00	0.00	
9	1	0	Unrestricted	298	Unrestricted	120	0.00	0.00	0.00	0.00	0.00	0.00	0.00	
10	1	0	Unrestricted	186	Unrestricted	120	0.00	0.00	0.00	0.00	0.00	0.00	0.00	
11	1	0	Unrestricted	363	Unrestricted	120	0.00	0.00	0.00	0.00	0.00	0.00	0.00	
12	1	0	Unrestricted	478	Unrestricted	120	0.00	0.00	0.00	0.00	0.00	0.00	0.00	

Traffic Stream Results: Flows and signals

Time Segment	Arm	Traffic Stream	Calculated flow entering (Veh/hr)	Calculated flow out (Veh/hr)	Flow discrepancy (Veh/hr)	Adjusted flow warning	Calculated sat flow (Veh/hr)	Calculated capacity (Veh/hr)	Degree of saturation (%)	DOS Threshold exceeded	Practical reserve capacity (%)	Mean modulus of error	Actual green (s per cycle)
08:00-09:00	A	1	233	233	0		1800	345	68		48	0.00	22
		2	65	65	0		1800	300	22		362	0.00	19
	Ax	1	258	258	0		Unrestricted	Unrestricted	0		Unrestricted	0.71	120
		2	258	258	0		Unrestricted	Unrestricted	0		Unrestricted	0.71	120
	B	1	153	153	0		1800	675	23		341	0.00	44
		2	33	33	0		1800	90	37		173	0.00	5
	Bx	1	628	628	0		Unrestricted	Unrestricted	0		Unrestricted	0.64	120
		2	628	628	0		Unrestricted	Unrestricted	0		Unrestricted	0.64	120
	C	1	152	152	0		1800	345	44		127	0.00	22
		2	211	211	0		1800	300	70		42	0.00	19
	Cx	1	203	203	0		Unrestricted	Unrestricted	0		Unrestricted	1.15	120
		2	203	203	0		Unrestricted	Unrestricted	0		Unrestricted	1.15	120
	D	1	447	447	0		1800	675	66		51	0.00	44
		2	31	31	0		1800	90	34		190	0.00	5
Dx	1	236	236	0		Unrestricted	Unrestricted	0		Unrestricted	0.78	120	
	2	236	236	0		Unrestricted	Unrestricted	0		Unrestricted	0.78	120	
9	1	298	298	0		Unrestricted	Unrestricted	0		Unrestricted	0.00	120	
10	1	186	186	0		Unrestricted	Unrestricted	0		Unrestricted	0.00	120	
11	1	363	363	0		Unrestricted	Unrestricted	0		Unrestricted	0.00	120	
12	1	478	478	0		Unrestricted	Unrestricted	0		Unrestricted	0.00	120	

Traffic Stream Results: Stops and delays

Time Segment	Arm	Traffic Stream	Mean Cruise Time per Veh (s)	Mean Delay per Veh (s)	Uniform delay (Veh-hr/hr)	Random plus oversat delay (Veh-hr/hr)	Weighted cost of delay (£ per hr)	Mean stops per Veh (%)	Uniform stops (Stops per hr)	Random stops (Stops per hr)	Weighted cost of stops (£ per hr)
08:00-09:00	A	1	2.40	55.64	2.92	0.69	51.13	99.98	212.83	20.13	2.92
		2	24.00	44.90	0.78	0.03	11.51	86.22	55.15	0.89	0.70
	Ax	1	21.95	0.00	0.00	0.00	0.00	0.00	0.00	0.00	0.00
	B	1	24.00	26.40	1.09	0.03	15.93	67.16	101.77	0.99	1.29
		2	2.16	66.58	0.51	0.10	8.67	104.94	31.57	3.06	0.43
	Bx	1	21.41	0.00	0.00	0.00	0.00	0.00	0.00	0.00	0.00
	C	1	24.00	46.91	1.81	0.17	28.12	89.89	131.50	5.13	1.71
		2	4.80	60.96	2.77	0.81	50.74	104.09	196.12	23.51	2.75
	Cx	1	23.38	0.00	0.00	0.00	0.00	0.00	0.00	0.00	0.00
	D	1	24.00	36.35	3.87	0.64	64.09	85.51	363.19	19.05	4.79
		2	3.60	65.46	0.47	0.09	8.00	103.29	29.40	2.62	0.40
	Dx	1	21.24	0.00	0.00	0.00	0.00	0.00	0.00	0.00	0.00
	9	1	5.82	0.00	0.00	0.00	0.00	0.00	0.00	0.00	0.00
	10	1	3.78	0.00	0.00	0.00	0.00	0.00	0.00	0.00	0.00
11	1	4.44	0.00	0.00	0.00	0.00	0.00	0.00	0.00	0.00	
12	1	4.12	0.00	0.00	0.00	0.00	0.00	0.00	0.00	0.00	

Traffic Stream Results: Queues and blocking

Time Segment	Arm	Traffic Stream	Initial queue (Veh)	Mean max queue (Veh)	Max queue storage (Veh)	Utilised storage (%)	Average storage excess queue (Veh)	Average limit excess queue (Veh)	Excess queue penalty (£ per hr)	Wasted time starvation (s per cycle)	Wasted time blocking back (s per cycle)	Wasted time total (s per cycle)	Estimated blocking
08:00-09:00	A	1	0.00	7.87	3.48	226.26	1.26	0.00	0.00	0.00	0.00	0.00	
		2	0.00	1.89	34.78	5.43	0.00	0.00	0.00	0.00	0.00	0.00	
	Ax	1	0.00	0.00	31.81	0.00	0.00	0.00	0.00	30.00	0.00	30.00	
	B	1	0.00	3.48	34.78	9.99	0.00	0.00	0.00	0.00	0.00	0.00	
		2	0.00	1.17	3.13	37.30	0.00	0.00	0.00	0.00	3.00	0.00	3.00
	Bx	1	0.00	0.00	31.03	0.00	0.00	0.00	0.00	17.00	0.00	17.00	
	C	1	0.00	4.61	34.78	13.24	0.00	0.00	0.00	0.00	0.00	0.00	
		2	0.00	7.43	6.96	106.80	0.02	0.00	0.00	0.00	0.00	0.00	
	Cx	1	0.00	0.00	33.88	0.00	0.00	0.00	0.00	63.00	0.00	63.00	
	D	1	0.00	12.93	34.78	37.19	0.00	0.00	0.00	0.00	0.00	0.00	
		2	0.00	1.08	5.22	20.69	0.00	0.00	0.00	0.00	4.00	0.00	4.00
	Dx	1	0.00	0.00	30.79	0.00	0.00	0.00	0.00	28.00	0.00	28.00	
	9	1	0.00	0.00	8.44	0.00	0.00	0.00	0.00	0.00	68.00	68.00	
	10	1	0.00	0.00	5.47	0.00	0.00	0.00	0.00	0.00	0.00	0.00	
11	1	0.00	0.00	6.44	0.00	0.00	0.00	0.00	0.00	9.00	9.00		
12	1	0.00	0.00	5.97	0.00	0.00	0.00	0.00	0.00	0.00	0.00		

Pedestrian Crossing Results

Pedestrian Crossings: Pedestrian summary

Time Segment	Crossing	Side	Degree of saturation (%)	Calculated Flow Entering (Ped/hr)	Calculated sat flow (Ped/hr)	Actual green (s per cycle)	Mean Delay Per Ped (s)	Mean max queue (Ped)	Weighted cost of delay (£ per hr)	Performance Index (£ per hr)
08:00-09:00	(ALL)	(ALL)	11	50	11000	5	55.58	1.60	10.96	10.96

Pedestrian Crossings: Flows and signals

Time Segment	Crossing	Side	Calculated flow entering (Ped/hr)	Calculated flow out (Ped/hr)	Flow discrepancy (Ped/hr)	Adjusted flow warning	Calculated sat flow (Ped/hr)	Calculated capacity (Ped/hr)	Degree of saturation (%)	DOS Threshold exceeded	Practical reserve capacity (%)	Mean modulus of error	Actual green (s per cycle)
08:00-09:00	(ALL)	(ALL)	50	50	0		11000	458	11		817	0.00	5

Pedestrian Crossings: Stops and delays

Time Segment	Crossing	Side	Mean Cruise Time per Ped (s)	Mean Delay per Ped (s)	Uniform delay (Ped-hr/hr)	Random plus oversat delay (Ped-hr/hr)	Weighted cost of delay (£ per hr)
08:00-09:00	1	1	5.67	55.58	0.77	0.00	10.96
		2	5.67	55.58	0.77	0.00	10.96
	2	1	6.33	55.58	0.77	0.00	10.96
		2	6.33	55.58	0.77	0.00	10.96
	3	1	6.33	55.58	0.77	0.00	10.96
		2	6.33	55.58	0.77	0.00	10.96
	4	1	5.67	55.58	0.77	0.00	10.96
		2	5.67	55.58	0.77	0.00	10.96

Pedestrian Crossings: Queues and blocking

Time Segment	Crossing	Side	Mean max queue (Ped)	Max queue storage (Ped)	Utilised storage (%)	Average storage excess queue (Ped)	Average limit excess queue (Ped)	Excess queue penalty (£ per hr)
08:00-09:00	(ALL)	(ALL)	1.60	10.00	15.97	0.00	0.00	0.00

Network Results

Network Results: Flows and signals

Time Segment	Calculated flow entering (Veh/hr)	Calculated flow out (Veh/hr)	Flow discrepancy (Veh/hr)	Adjusted flow warning	Degree of saturation (%)	DOS Threshold exceeded	Practical reserve capacity (%)	Actual green (s (per cycle))
08:00-09:00	4375	4375	0		70		42	1180

Network Results: Stops and delays

Time Segment	Mean Cruise Time per Veh (s)	Mean Delay per Veh (s)	Uniform delay (Veh-hr/hr)	Random plus oversat delay (Veh-hr/hr)	Weighted cost of delay (£ per hr)	Mean stops per Veh (%)	Uniform stops (Stops per hr)	Random stops (Stops per hr)	Weighted cost of stops (£ per hr)
08:00-09:00	13.41	18.89	20.39	2.56	325.90	27.36	1121.54	75.38	15.01

Network Results: Queues and blocking

Time Segment	Utilised storage (%)	Excess queue penalty (£ per hr)	Wasted time starvation (s (per cycle))	Wasted time blocking back (s (per cycle))	Wasted time total (s (per cycle))
08:00-09:00	226.26	0.00	145.00	77.00	222.00

Final Prediction Table

Traffic Stream Results

Arm	Traffic Stream	Name	Traffic node	SIGNALS		FLOWS		PERFORMANCE				PER PCU			QUEUES
				Controller stream	Phase	Calculated flow entering (Veh/hr)	Calculated sat flow (Veh/hr)	Actual green (s per cycle)	Wasted time total (s per cycle)	Degree of saturation (%)	Practical reserve capacity (%)	JourneyTime (s)	Mean Delay per Veh (s)	Mean stops per Veh (%)	Mean max queue (Veh)
A	1	(untitled)	1	1	D	233 <	1800	22	0.00	68	48	58.04	55.64	99.98	7.87 +
	2		1	1	C	65	1800	19	0.00	22	362	68.90	44.90	86.22	1.89
Ax	1	(untitled)				258	Unrestricted	120	30.00	0	Unrestricted	21.95	0.00	0.00	0.00
B	1	(untitled)	1	1	B	153	1800	44	0.00	23	341	50.40	26.40	67.16	3.48
	2		1	1	A	33	1800	5	3.00	37	173	68.74	66.58	104.94	1.17
Bx	1	(untitled)				628	Unrestricted	120	17.00	0	Unrestricted	21.41	0.00	0.00	0.00
C	1	(untitled)	1	1	D	152	1800	22	0.00	44	127	70.91	46.91	89.89	4.61
	2		1	1	C	211 <	1800	19	0.00	70	42	65.76	60.96	104.09	7.43 +
Cx	1	(untitled)				203	Unrestricted	120	63.00	0	Unrestricted	23.38	0.00	0.00	0.00
D	1	(untitled)	1	1	B	447	1800	44	0.00	66	51	60.35	36.35	85.51	12.93
	2		1	1	A	31	1800	5	4.00	34	190	69.06	65.46	103.29	1.08
Dx	1	(untitled)				236	Unrestricted	120	28.00	0	Unrestricted	21.24	0.00	0.00	0.00
9	1		1			298	Unrestricted	120	68.00	0	Unrestricted	5.82	0.00	0.00	0.00
10	1		1			186	Unrestricted	120	0.00	0	Unrestricted	3.78	0.00	0.00	0.00
11	1		1			363	Unrestricted	120	9.00	0	Unrestricted	4.44	0.00	0.00	0.00
12	1		1			478	Unrestricted	120	0.00	0	Unrestricted	4.12	0.00	0.00	0.00

Pedestrian Crossing Results

Pedestrian	Side	Name	Traffic node	SIGNALS		FLOWS		PERFORMANCE			PER PED		QUEUES	WEIGHTS	PEN
				Controller stream	Phase	Calculated Flow Entering (Ped/hr)	Calculated sat flow (Ped/hr)	Actual green (s per cycle)	Degree of saturation (%)	Practical reserve capacity (%)	JourneyTime (s)	Mean Delay per Ped (s)	Mean max queue (Ped)	Delay weighting (%)	Co tra pen (£ p
1	1	(untitled)	1	1	E	50	11000	5	11	817	61.25	55.58	1.60	100	0
	2	(untitled)	1	1	E	50	11000	5	11	817	61.25	55.58	1.60	100	0
2	1	(untitled)	1	1	E	50	11000	5	11	817	61.92	55.58	1.60	100	0
	2	(untitled)	1	1	E	50	11000	5	11	817	61.92	55.58	1.60	100	0
3	1	(untitled)	1	1	E	50	11000	5	11	817	61.92	55.58	1.60	100	0
	2	(untitled)	1	1	E	50	11000	5	11	817	61.92	55.58	1.60	100	0
4	1	(untitled)	1	1	E	50	11000	5	11	817	61.25	55.58	1.60	100	0
	2	(untitled)	1	1	E	50	11000	5	11	817	61.25	55.58	1.60	100	0

Network Results

	Distance travelled (PCU-km/hr)	Time spent (PCU-hr/hr)	Mean journey speed (kph)	Uniform delay (Veh-hr/hr)	Random plus oversat delay (Veh-hr/hr)	Weighted cost of delay (£ per hr)	Weighted cost of stops (£ per hr)	Excess queue penalty (£ per hr)	Performance Index (£ per hr)
Normal traffic	468.78	32.40	14.47	14.21	2.56	238.20	15.01	0.00	253.21
Bus	0.00	0.00	0.00	0.00	0.00	0.00	0.00	0.00	0.00
Tram	0.00	0.00	0.00	0.00	0.00	0.00	0.00	0.00	0.00
Pedestrians	3.40	6.84	0.50	6.18	0.00	87.70	0.00	0.00	87.70
TOTAL	472.18	39.24	12.03	20.39	2.56	325.90	15.01	0.00	340.91

- 1 < = adjusted flow warning (upstream links/traffic streams are over-saturated)
- 1 * = Traffic Stream - Normal, Bus or Tram Stop or Delay weighting has been set to a value other than 100%
- 1 ^ = Traffic Stream - Normal, Bus or Tram Stop or Delay Path weighting has been set to a value other than 100%
- 1 + = average link/traffic stream excess queue is greater than 0
- 1 P.I. = PERFORMANCE INDEX

A2 - DO NOTHING 2024 D2 - DO NOTHING 2024*

Summary

Data Errors and Warnings

No errors or warnings

Run Summary

Analysis set used	Run start time	Run finish time	Modelling start time (HH:mm)	Network Cycle Time (s)	Performance Index (£ per hr)	Total network delay (Veh-hr/hr)	Highest DOS (%)	Item with highest DOS	Number of oversaturated items	Percentage of oversaturated items (%)	Item with worst signalised PRC	Item with worst unsignalised PRC	Item with worst over PR
2	19/08/2020 12:04:15	19/08/2020 12:04:16	08:00	120	385.38	25.93	74.26	D/1	0	0	D/1	Dx/1	D/

Analysis Set Details

Name	Description	Demand set	Include in report	Locked
DO NOTHING 2024		D2	✓	

Demand Set Details

Name	Description	Composite	Demand sets	Start time (HH:mm)	Locked
DO NOTHING 2024				08:00	

Arms and Traffic Streams

Arms

Arm	Name	Description	Traffic node
A	(untitled)		1
Ax	(untitled)		
B	(untitled)		1
Bx	(untitled)		
C	(untitled)		1
Cx	(untitled)		
D	(untitled)		1
Dx	(untitled)		
9			1
10			1
11			1
12			1

Traffic Streams

Arm	Traffic Stream	Name	Description	Auto length	Length (m)	Has Saturation Flow	Saturation flow source	Saturation flow (PCU/hr)	Is signal controlled	Is give way	Traffic type	Allow Nearside Turn On Red
A	1	(untitled)			20.00	✓	Sum of lanes	1800	✓		Normal	
	2				200.00	✓	Sum of lanes	1800	✓		Normal	
Ax	1	(untitled)		✓	182.93						Normal	
B	1	(untitled)			200.00	✓	Sum of lanes	1800	✓		Normal	
	2				18.00	✓	Sum of lanes	1800	✓		Normal	
Bx	1	(untitled)		✓	178.44						Normal	
C	1	(untitled)			200.00	✓	Sum of lanes	1800	✓		Normal	
	2				40.00	✓	Sum of lanes	1800	✓		Normal	
Cx	1	(untitled)		✓	194.82						Normal	
D	1	(untitled)			200.00	✓	Sum of lanes	1800	✓		Normal	
	2				30.00	✓	Sum of lanes	1800	✓		Normal	
Dx	1	(untitled)		✓	177.04						Normal	
9	1			✓	48.53						Normal	
10	1			✓	31.46						Normal	
11	1			✓	37.01						Normal	
12	1			✓	34.36						Normal	

Lanes

Arm	Traffic Stream	Lane	Name	Description	Use RR67	Saturation flow (PCU/hr)
A	1	1	(untitled)			1800
	2	1	(untitled)			1800
Ax	1	1	(untitled)			
B	1	1	(untitled)			1800
	2	1	(untitled)			1800
Bx	1	1	(untitled)			
C	1	1	(untitled)			1800
	2	1	(untitled)			1800
Cx	1	1	(untitled)			
D	1	1	(untitled)			1800
	2	1	(untitled)			1800
Dx	1	1	(untitled)			
9	1	1	(untitled)			
10	1	1	(untitled)			
11	1	1	(untitled)			
12	1	1	(untitled)			

Modelling

Arm	Traffic Stream	Traffic model	Stop weighting multiplier (%)	Delay weighting multiplier (%)	Assignment Cost Weighting (%)	Exclude from results calculation	Max queue storage (PCU)	Has queue limit	Has degree of saturation limit
(ALL)	(ALL)	NetworkDefault	100	100	100		0.00		

Modelling - Advanced

Arm	Traffic Stream	Initial queue (PCU)	Type of Vehicle-in-Service	Vehicle-in-Service	Type of random parameter	Random parameter	Auto cycle time	Cycle time
(ALL)	(ALL)	0.00	NetworkDefault	Not-Included	NetworkDefault	0.50	✓	120

Normal traffic - Modelling

Arm	Traffic Stream	Stop weighting (%)	Delay weighting (%)
(ALL)	(ALL)	100	100

Normal traffic - Advanced

Arm	Traffic Stream	Dispersion type for Normal Traffic
(ALL)	(ALL)	NetworkDefault

Flows

Arm	Traffic Stream	Total Flow (Veh/hr)	Normal Flow (Veh/hr)
A	1	256	256
	2	70	70
Ax	1	288	288
B	1	164	164
	2	35	35
Bx	1	691	691
C	1	176	176
	2	244	244
Cx	1	224	224
D	1	479	479
	2	34	34
Dx	1	255	255
9	1	326	326
10	1	199	199
11	1	420	420
12	1	513	513

Signals

Arm	Traffic Stream	Controller stream	Phase	Second phase enabled
A	1	1	D	
	2	1	C	
B	1	1	B	
	2	1	A	
C	1	1	D	
	2	1	C	
D	1	1	B	
	2	1	A	

Pedestrian Crossings

Pedestrian Crossings

Crossing	Name	Description	Traffic node	Allow walk on red	Crossing type	Length (m)	Cruise time (seconds)	Cruise speed (kph)
1	(untitled)		1		Farside	7.00	4.67	5.40
2	(untitled)		1		Farside	8.00	5.33	5.40
3	(untitled)		1		Farside	8.00	5.33	5.40
4	(untitled)		1		Farside	7.00	4.67	5.40

Pedestrian Crossings - Signals

Crossing	Controller stream	Phase	Second phase enabled
(ALL)	1	E	

Pedestrian Crossings - Sides

Crossing	Side	Saturation flow (Ped/hr)
(ALL)	(ALL)	11000

Pedestrian Crossings - Modelling

Crossing	Side	Delay weighting (%)	Assignment Cost Weighting (%)	Exclude from results calculation	Max queue storage (Ped)	Has queue limit	Has degree of saturation limit
(ALL)	(ALL)	100	100		0.00		

Local OD Matrix - Local Matrix: 1

Local Matrix Options

OD Matrix	Name	Use for point to point table	Auto calculate	Allocation mode	Allow paths past exit locations	Allow looped paths on arms	Allow looped paths on traffic nodes	Copy flows	Matrix to copy flows from	Limit paths by length	Path length limit multiplier	Limit paths by number	Path number limit
1	(untitled)	✓	✓	Path Equalisation	✓		✓			✓	1.25		

Normal Input Flows (Veh/hr)

	To							
	1	2	3	4	5	6	7	8
From 1	0	26	150	244	0	0	0	0
From 2	34	0	103	376	0	0	0	0
From 3	185	70	0	71	0	0	0	0
From 4	5	159	35	0	0	0	0	0
From 5	0	0	0	0	0	0	0	0
From 6	0	0	0	0	0	0	0	0
From 7	0	0	0	0	0	0	0	0
From 8	0	0	0	0	0	0	0	0

Bus Input Flows not shown as they are blank.

Tram Input Flows not shown as they are blank.

Pedestrian Input Flows (Veh/hr)

	To							
	1	2	3	4	5	6	7	8
From 1	0	0	0	0	0	0	0	0
From 2	0	0	0	0	0	0	0	0
From 3	0	0	0	0	0	0	0	0
From 4	0	0	0	0	0	0	0	0
From 5	0	0	0	0	0	50	50	0
From 6	0	0	0	0	50	0	0	50
From 7	0	0	0	0	50	0	0	50
From 8	0	0	0	0	0	50	50	0

Locations

OD Matrix	Location	Name	Entries	Exits	Colour
1	1	(untitled)	11/1	Cx/1	#0000FF
	2	(untitled)	12/1	Dx/1	#FF0000
	3	(untitled)	9/1	Ax/1	#00FF00
	4	(untitled)	10/1	Bx/1	#FFFF00
	5	(untitled)	3:2E, 1:1E	3:2X, 1:1X	#FF00FF
	6	(untitled)	2:1E, 1:2E	2:1X, 1:2X	#008000
	7	(untitled)	4:2E, 3:1E	4:2X, 3:1X	#FFA500
	8	(untitled)	4:1E, 2:2E	4:1X, 2:2X	#00FFFF

Normal Paths and Flows

OD Matrix	Path	Description	From location	To location	Path items	Allocation type	Normal Calculated Flow (Veh/hr)
1	9		4	3	10/1, B/2, Ax/1	Normal	35
	10		3	4	9/1, A/1, Bx/1	Normal	71
	11		1	3	11/1, C/1, Ax/1	Normal	150
	12		1	4	11/1, C/2, Bx/1	Normal	244
	13		3	1	9/1, A/1, Cx/1	Normal	185
	14		4	1	10/1, B/1, Cx/1	Normal	5
	15		2	3	12/1, D/1, Ax/1	Normal	103
	16		2	4	12/1, D/1, Bx/1	Normal	376
	19		3	2	9/1, A/2, Dx/1	Normal	70
	20		4	2	10/1, B/1, Dx/1	Normal	159
	43		2	1	12/1, D/2, Cx/1	Normal	34
	44		1	2	11/1, C/1, Dx/1	Normal	26

Pedestrian Paths and Flows

OD Matrix	Path	Description	From location	To location	Path items	Allocation type	Pedestrian calculated flow (Ped/hr)
1	17		8	7	4:1E, 4:2X	Normal	50
	18		8	6	2:2E, 2:1X	Normal	50
	22		5	7	3:2E, 3:1X	Normal	50
	23		5	6	1:1E, 1:2X	Normal	50
	34		6	8	2:1E, 2:2X	Normal	50
	35		6	5	1:2E, 1:1X	Normal	50
	41		7	8	4:2E, 4:1X	Normal	50
	42		7	5	3:1E, 3:2X	Normal	50

Signal Timings

Network Default: 120s cycle time; 120 steps

Controller Stream 1

Controller Stream	Name	Description	Use sequence	Cycle time source	Cycle time (s)
1	(untitled)		1	NetworkDefault	120

Controller Stream 1 - Properties

Controller Stream	Manufacturer name	Type	Model number	(Telephone) Line Number	Site number	Grid reference	Gaining delay type
1	Unspecified						Relative

Controller Stream 1 - Optimisation

Controller Stream	Allow offset optimisation	Allow green split optimisation	Optimisation level	Auto redistribute	Enable stage constraint
1	✓	✓	Offsets And Green Splits	✓	

Phases

Controller Stream	Phase	Name	Minimum green (s)	Maximum green (s)	Relative start displacement (s)	Relative end displacement (s)	Type	Blackout Time (s)
1	A	(untitled)	5	70	0	0	Traffic	
	B	(untitled)	7	70	0	0	Traffic	
	C	(untitled)	7	70	0	0	Traffic	
	D	(untitled)	7	70	0	0	Traffic	
	E	(untitled)	5	5	0	0	Pedestrian	0

Library Stages

Controller Stream	Library Stage	Phases in stage	User stage minimum (s)
1	1	A	1
	2	B	1
	3	C	1
	4	D	1
	5	E	1

Stage Sequences

Controller Stream	Sequence	Name	Multiple cycling	Stage IDs	Stage ends
1	1	(untitled)	Single	1, 2, 3, 4, 5	114, 41, 67, 94, 104

Intergreen Matrix for Controller Stream 1

		To				
		A	B	C	D	E
From	A		5	5	5	5
	B	5		5	5	5
	C	5	5		5	5
	D	5	5	5		5
	E	5	5	5	5	

Banned Stage transitions for Controller Stream 1

		To				
		1	2	3	4	5
From	1					
	2					
	3					
	4					
	5					

Interstage Matrix for Controller Stream 1

		To				
		1	2	3	4	5
From	1	0	5	5	5	5
	2	5	0	5	5	5
	3	5	5	0	5	5
	4	5	5	5	0	5
	5	5	5	5	5	0

Resultant Stages

Controller Stream	Resultant Stage	Is base stage	Library Stage ID	Phases in this stage	Stage start (s)	Stage end (s)	Stage duration (s)	User stage minimum (s)	Stage minimum (s)
1	1	✓	1	A	109	114	5	1	5
	2	✓	2	B	119	41	42	1	7
	3	✓	3	C	46	67	21	1	7
	4	✓	4	D	72	94	22	1	7
	5	✓	5	E	99	104	5	1	5

Resultant Phase Green Periods

Controller Stream	Phase	Green period	Is base green period	Start time (s)	End time (s)	Duration (s)
1	A	1	✓	109	114	5
	B	1	✓	119	41	42
	C	1	✓	46	67	21
	D	1	✓	72	94	22
	E	1	✓	99	104	5

Traffic Stream Green Times

Arm	Traffic Stream	Traffic Node	Controller Stream	Phase	Green Period 1		
					Start	End	Duration
A	1	1	1	D	72	94	22
A	2	1	1	C	46	67	21
B	1	1	1	B	119	41	42
B	2	1	1	A	109	114	5
C	1	1	1	D	72	94	22
C	2	1	1	C	46	67	21
D	1	1	1	B	119	41	42
D	2	1	1	A	109	114	5

Phase Timings Diagram for Controller Stream 1

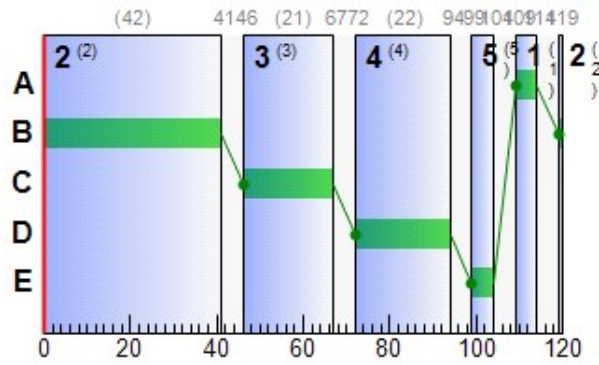

Stage Sequence Diagram for Controller Stream 1

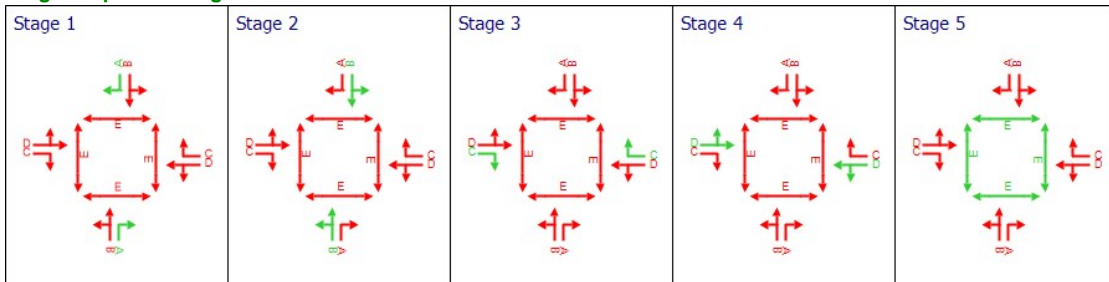

Resultant penalties

Time Segment	Controller stream	Phase min max penalty (£ per hr)	Intergreen broken penalty (£ per hr)	Stage constraint broken penalty (£ per hr)	Cost of controller stream penalties (£ per hr)
08:00-09:00	1	0.00	0.00	0.00	0.00

Traffic Stream Results

Traffic Stream Results: Vehicle summary

Time Segment	Arm	Traffic Stream	Degree of saturation (%)	Practical reserve capacity (%)	Calculated flow entering (Veh/hr)	Calculated sat flow (Veh/hr)	Actual green (s per cycle)	Mean Delay per Veh (s)	Mean max queue (Veh)	Utilised storage (%)	Weighted cost of delay (£ per hr)	Weighted cost of stops (£ per hr)	Performance Index (£ per hr)	
08:00-09:00	A	1	74	35	256	1800	22	60.14	9.06	260.53	60.73	3.35	64.07	
		2	21	371	70	1800	21	43.11	1.99	5.73	11.90	0.74	12.64	
	Ax	1	0	Unrestricted	288	Unrestricted	120	0.00	0.00	0.00	0.00	0.00	0.00	0.00
		2	0	Unrestricted	288	Unrestricted	120	0.00	0.00	0.00	0.00	0.00	0.00	0.00
	B	1	25	293	164	1800	42	28.14	3.87	11.13	18.20	1.44	19.64	
		2	39	157	35	1800	5	67.76	1.25	39.91	9.35	0.46	9.82	
	Bx	1	0	Unrestricted	691	Unrestricted	120	0.00	0.00	0.00	0.00	0.00	0.00	0.00
		2	0	Unrestricted	691	Unrestricted	120	0.00	0.00	0.00	0.00	0.00	0.00	0.00
	C	1	51	96	176	1800	22	48.85	5.49	15.80	33.91	2.04	35.95	
		2	74	35	244	1800	21	61.17	8.67	124.59	58.87	3.21	62.08	
	Cx	1	0	Unrestricted	224	Unrestricted	120	0.00	0.00	0.00	0.00	0.00	0.00	0.00
		2	0	Unrestricted	224	Unrestricted	120	0.00	0.00	0.00	0.00	0.00	0.00	0.00
	D	1	74	35	479	1800	42	41.55	14.89	42.80	78.50	5.52	84.01	
		2	38	165	34	1800	5	67.16	1.21	23.16	9.01	0.45	9.46	
Dx	1	0	Unrestricted	255	Unrestricted	120	0.00	0.00	0.00	0.00	0.00	0.00	0.00	
	2	0	Unrestricted	255	Unrestricted	120	0.00	0.00	0.00	0.00	0.00	0.00	0.00	
9	1	0	Unrestricted	326	Unrestricted	120	0.00	0.00	0.00	0.00	0.00	0.00	0.00	
10	1	0	Unrestricted	199	Unrestricted	120	0.00	0.00	0.00	0.00	0.00	0.00	0.00	
11	1	0	Unrestricted	420	Unrestricted	120	0.00	0.00	0.00	0.00	0.00	0.00	0.00	
12	1	0	Unrestricted	513	Unrestricted	120	0.00	0.00	0.00	0.00	0.00	0.00	0.00	

Traffic Stream Results: Flows and signals

Time Segment	Arm	Traffic Stream	Calculated flow entering (Veh/hr)	Calculated flow out (Veh/hr)	Flow discrepancy (Veh/hr)	Adjusted flow warning	Calculated sat flow (Veh/hr)	Calculated capacity (Veh/hr)	Degree of saturation (%)	DOS Threshold exceeded	Practical reserve capacity (%)	Mean modulus of error	Actual green (s per cycle)
08:00-09:00	A	1	256	256	0		1800	345	74		35	0.00	22
		2	70	70	0		1800	330	21		371	0.00	21
	Ax	1	288	288	0		Unrestricted	Unrestricted	0		Unrestricted	0.69	120
		2	288	288	0		Unrestricted	Unrestricted	0		Unrestricted	0.69	120
	B	1	164	164	0		1800	645	25		293	0.00	42
		2	35	35	0		1800	90	39		157	0.00	5
	Bx	1	691	691	0		Unrestricted	Unrestricted	0		Unrestricted	0.63	120
		2	691	691	0		Unrestricted	Unrestricted	0		Unrestricted	0.63	120
	C	1	176	176	0		1800	345	51		96	0.00	22
		2	244	244	0		1800	330	74		35	0.00	21
	Cx	1	224	224	0		Unrestricted	Unrestricted	0		Unrestricted	1.14	120
		2	224	224	0		Unrestricted	Unrestricted	0		Unrestricted	1.14	120
	D	1	479	479	0		1800	645	74		35	0.00	42
		2	34	34	0		1800	90	38		165	0.00	5
Dx	1	255	255	0		Unrestricted	Unrestricted	0		Unrestricted	0.78	120	
	2	255	255	0		Unrestricted	Unrestricted	0		Unrestricted	0.78	120	
9	1	326	326	0		Unrestricted	Unrestricted	0		Unrestricted	0.00	120	
10	1	199	199	0		Unrestricted	Unrestricted	0		Unrestricted	0.00	120	
11	1	420	420	0		Unrestricted	Unrestricted	0		Unrestricted	0.00	120	
12	1	513	513	0		Unrestricted	Unrestricted	0		Unrestricted	0.00	120	

Traffic Stream Results: Stops and delays

Time Segment	Arm	Traffic Stream	Mean Cruise Time per Veh (s)	Mean Delay per Veh (s)	Uniform delay (Veh-hr/hr)	Random plus oversat delay (Veh-hr/hr)	Weighted cost of delay (£ per hr)	Mean stops per Veh (%)	Uniform stops (Stops per hr)	Random stops (Stops per hr)	Weighted cost of stops (£ per hr)	
08:00-09:00	A	1	2.40	60.14	3.25	1.03	60.73	104.23	236.93	29.89	3.35	
		2	24.00	43.11	0.81	0.03	11.90	84.40	58.23	0.85	0.74	
	Ax	1	21.95	0.00	0.00	0.00	0.00	0.00	0.00	0.00	0.00	0.00
		2	24.00	28.14	1.24	0.04	18.20	69.79	113.16	1.30	1.44	
	B	1	24.00	28.14	1.24	0.04	18.20	69.79	113.16	1.30	1.44	
		2	2.16	67.76	0.54	0.12	9.35	105.83	33.49	3.55	0.46	
	Bx	1	21.41	0.00	0.00	0.00	0.00	0.00	0.00	0.00	0.00	0.00
		2	24.00	48.85	2.12	0.26	33.91	92.55	155.07	7.81	2.04	
	C	1	24.00	48.85	2.12	0.26	33.91	92.55	155.07	7.81	2.04	
		2	4.80	61.17	3.14	1.01	58.87	104.99	226.84	29.32	3.21	
	Cx	1	23.38	0.00	0.00	0.00	0.00	0.00	0.00	0.00	0.00	0.00
		2	24.00	41.55	4.48	1.05	78.50	91.89	409.21	30.95	5.52	
	D	1	24.00	41.55	4.48	1.05	78.50	91.89	409.21	30.95	5.52	
		2	3.60	67.16	0.52	0.11	9.01	105.38	32.53	3.30	0.45	
Dx	1	21.24	0.00	0.00	0.00	0.00	0.00	0.00	0.00	0.00	0.00	
	2	5.82	0.00	0.00	0.00	0.00	0.00	0.00	0.00	0.00	0.00	
9	1	5.82	0.00	0.00	0.00	0.00	0.00	0.00	0.00	0.00	0.00	
10	1	3.78	0.00	0.00	0.00	0.00	0.00	0.00	0.00	0.00	0.00	
11	1	4.44	0.00	0.00	0.00	0.00	0.00	0.00	0.00	0.00	0.00	
12	1	4.12	0.00	0.00	0.00	0.00	0.00	0.00	0.00	0.00	0.00	

Traffic Stream Results: Queues and blocking

Time Segment	Arm	Traffic Stream	Initial queue (Veh)	Mean max queue (Veh)	Max queue storage (Veh)	Utilised storage (%)	Average storage excess queue (Veh)	Average limit excess queue (Veh)	Excess queue penalty (£ per hr)	Wasted time starvation (s per cycle)	Wasted time blocking back (s per cycle)	Wasted time total (s per cycle)	Estimated blocking	
08:00-09:00	A	1	0.00	9.06	3.48	260.53	1.85	0.00	0.00	0.00	0.00	0.00		
		2	0.00	1.99	34.78	5.73	0.00	0.00	0.00	0.00	0.00	0.00	0.00	
	Ax	1	0.00	0.00	31.81	0.00	0.00	0.00	0.00	0.00	29.00	0.00	29.00	
		2	0.00	3.87	34.78	11.13	0.00	0.00	0.00	0.00	0.00	0.00	0.00	
	B	1	0.00	3.87	34.78	11.13	0.00	0.00	0.00	0.00	0.00	0.00	0.00	
		2	0.00	1.25	3.13	39.91	0.00	0.00	0.00	0.00	3.00	0.00	3.00	
	Bx	1	0.00	0.00	31.03	0.00	0.00	0.00	0.00	0.00	16.00	0.00	16.00	
		2	0.00	5.49	34.78	15.80	0.00	0.00	0.00	0.00	0.00	0.00	0.00	
	C	1	0.00	5.49	34.78	15.80	0.00	0.00	0.00	0.00	0.00	0.00	0.00	
		2	0.00	8.67	6.96	124.59	0.19	0.00	0.00	0.00	0.00	0.00	0.00	
	Cx	1	0.00	0.00	33.88	0.00	0.00	0.00	0.00	0.00	62.00	0.00	62.00	
		2	0.00	14.89	34.78	42.80	0.00	0.00	0.00	0.00	0.00	0.00	0.00	
	D	1	0.00	14.89	34.78	42.80	0.00	0.00	0.00	0.00	0.00	0.00	0.00	
		2	0.00	1.21	5.22	23.16	0.00	0.00	0.00	0.00	3.00	0.00	3.00	
Dx	1	0.00	0.00	30.79	0.00	0.00	0.00	0.00	0.00	26.00	0.00	26.00		
	2	0.00	0.00	8.44	0.00	0.00	0.00	0.00	0.00	0.00	79.00	79.00		
9	1	0.00	0.00	8.44	0.00	0.00	0.00	0.00	0.00	0.00	79.00	79.00		
10	1	0.00	0.00	5.47	0.00	0.00	0.00	0.00	0.00	0.00	0.00	0.00		
11	1	0.00	0.00	6.44	0.00	0.00	0.00	0.00	0.00	0.00	26.00	26.00		
12	1	0.00	0.00	5.97	0.00	0.00	0.00	0.00	0.00	0.00	0.00	0.00		

Pedestrian Crossing Results

Pedestrian Crossings: Pedestrian summary

Time Segment	Crossing	Side	Degree of saturation (%)	Calculated Flow Entering (Ped/hr)	Calculated sat flow (Ped/hr)	Actual green (s per cycle)	Mean Delay Per Ped (s)	Mean max queue (Ped)	Weighted cost of delay (£ per hr)	Performance Index (£ per hr)
08:00-09:00	(ALL)	(ALL)	11	50	11000	5	55.58	1.60	10.96	10.96

Pedestrian Crossings: Flows and signals

Time Segment	Crossing	Side	Calculated flow entering (Ped/hr)	Calculated flow out (Ped/hr)	Flow discrepancy (Ped/hr)	Adjusted flow warning	Calculated sat flow (Ped/hr)	Calculated capacity (Ped/hr)	Degree of saturation (%)	DOS Threshold exceeded	Practical reserve capacity (%)	Mean modulus of error	Actual green (s per cycle)
08:00-09:00	(ALL)	(ALL)	50	50	0		11000	458	11		817	0.00	5

Pedestrian Crossings: Stops and delays

Time Segment	Crossing	Side	Mean Cruise Time per Ped (s)	Mean Delay per Ped (s)	Uniform delay (Ped-hr/hr)	Random plus oversat delay (Ped-hr/hr)	Weighted cost of delay (£ per hr)
08:00-09:00	1	1	5.67	55.58	0.77	0.00	10.96
		2	5.67	55.58	0.77	0.00	10.96
	2	1	6.33	55.58	0.77	0.00	10.96
		2	6.33	55.58	0.77	0.00	10.96
	3	1	6.33	55.58	0.77	0.00	10.96
		2	6.33	55.58	0.77	0.00	10.96
	4	1	5.67	55.58	0.77	0.00	10.96
		2	5.67	55.58	0.77	0.00	10.96

Pedestrian Crossings: Queues and blocking

Time Segment	Crossing	Side	Mean max queue (Ped)	Max queue storage (Ped)	Utilised storage (%)	Average storage excess queue (Ped)	Average limit excess queue (Ped)	Excess queue penalty (£ per hr)
08:00-09:00	(ALL)	(ALL)	1.60	10.00	15.97	0.00	0.00	0.00

Network Results

Network Results: Flows and signals

Time Segment	Calculated flow entering (Veh/hr)	Calculated flow out (Veh/hr)	Flow discrepancy (Veh/hr)	Adjusted flow warning	Degree of saturation (%)	DOS Threshold exceeded	Practical reserve capacity (%)	Actual green (s (per cycle))
08:00-09:00	4774	4774	0		74		35	1180

Network Results: Stops and delays

Time Segment	Mean Cruise Time per Veh (s)	Mean Delay per Veh (s)	Uniform delay (Veh-hr/hr)	Random plus oversat delay (Veh-hr/hr)	Weighted cost of delay (£ per hr)	Mean stops per Veh (%)	Uniform stops (Stops per hr)	Random stops (Stops per hr)	Weighted cost of stops (£ per hr)
08:00-09:00	13.43	19.55	22.28	3.65	368.17	28.75	1265.47	106.97	17.21

Network Results: Queues and blocking

Time Segment	Utilised storage (%)	Excess queue penalty (£ per hr)	Wasted time starvation (s (per cycle))	Wasted time blocking back (s (per cycle))	Wasted time total (s (per cycle))
08:00-09:00	260.53	0.00	139.00	105.00	244.00

Final Prediction Table

Traffic Stream Results

Arm	Traffic Stream	Name	Traffic node	SIGNALS		FLOWS		PERFORMANCE				PER PCU			QUEUES
				Controller stream	Phase	Calculated flow entering (Veh/hr)	Calculated sat flow (Veh/hr)	Actual green (s per cycle)	Wasted time total (s per cycle)	Degree of saturation (%)	Practical reserve capacity (%)	JourneyTime (s)	Mean Delay per Veh (s)	Mean stops per Veh (%)	Mean max queue (Veh)
A	1	(untitled)	1	1	D	256 <	1800	22	0.00	74	35	62.54	60.14	104.23	9.06 +
	2		1	1	C	70	1800	21	0.00	21	371	67.11	43.11	84.40	1.99
Ax	1	(untitled)				288	Unrestricted	120	29.00	0	Unrestricted	21.95	0.00	0.00	0.00
B	1	(untitled)	1	1	B	164	1800	42	0.00	25	293	52.14	28.14	69.79	3.87
	2		1	1	A	35	1800	5	3.00	39	157	69.92	67.76	105.83	1.25
Bx	1	(untitled)				691	Unrestricted	120	16.00	0	Unrestricted	21.41	0.00	0.00	0.00
C	1	(untitled)	1	1	D	176	1800	22	0.00	51	96	72.85	48.85	92.55	5.49
	2		1	1	C	244 <	1800	21	0.00	74	35	65.97	61.17	104.99	8.67 +
Cx	1	(untitled)				224	Unrestricted	120	62.00	0	Unrestricted	23.38	0.00	0.00	0.00
D	1	(untitled)	1	1	B	479	1800	42	0.00	74	35	65.55	41.55	91.89	14.89
	2		1	1	A	34	1800	5	3.00	38	165	70.76	67.16	105.38	1.21
Dx	1	(untitled)				255	Unrestricted	120	26.00	0	Unrestricted	21.24	0.00	0.00	0.00
9	1		1			326	Unrestricted	120	79.00	0	Unrestricted	5.82	0.00	0.00	0.00
10	1		1			199	Unrestricted	120	0.00	0	Unrestricted	3.78	0.00	0.00	0.00
11	1		1			420	Unrestricted	120	26.00	0	Unrestricted	4.44	0.00	0.00	0.00
12	1		1			513	Unrestricted	120	0.00	0	Unrestricted	4.12	0.00	0.00	0.00

Pedestrian Crossing Results

Pedestrian	Side	Name	Traffic node	SIGNALS		FLOWS		PERFORMANCE			PER PED		QUEUES	WEIGHTS	PEN
				Controller stream	Phase	Calculated Flow Entering (Ped/hr)	Calculated sat flow (Ped/hr)	Actual green (s per cycle)	Degree of saturation (%)	Practical reserve capacity (%)	JourneyTime (s)	Mean Delay per Ped (s)	Mean max queue (Ped)	Delay weighting (%)	Co tra pen (£ p
1	1	(untitled)	1	1	E	50	11000	5	11	817	61.25	55.58	1.60	100	0
	2	(untitled)	1	1	E	50	11000	5	11	817	61.25	55.58	1.60	100	0
2	1	(untitled)	1	1	E	50	11000	5	11	817	61.92	55.58	1.60	100	0
	2	(untitled)	1	1	E	50	11000	5	11	817	61.92	55.58	1.60	100	0
3	1	(untitled)	1	1	E	50	11000	5	11	817	61.92	55.58	1.60	100	0
	2	(untitled)	1	1	E	50	11000	5	11	817	61.92	55.58	1.60	100	0
4	1	(untitled)	1	1	E	50	11000	5	11	817	61.25	55.58	1.60	100	0
	2	(untitled)	1	1	E	50	11000	5	11	817	61.25	55.58	1.60	100	0

Network Results

	Distance travelled (PCU-km/hr)	Time spent (PCU-hr/hr)	Mean journey speed (kph)	Uniform delay (Veh-hr/hr)	Random plus oversat delay (Veh-hr/hr)	Weighted cost of delay (£ per hr)	Weighted cost of stops (£ per hr)	Excess queue penalty (£ per hr)	Performance Index (£ per hr)
Normal traffic	514.35	36.90	13.94	16.10	3.65	280.47	17.21	0.00	297.68
Bus	0.00	0.00	0.00	0.00	0.00	0.00	0.00	0.00	0.00
Tram	0.00	0.00	0.00	0.00	0.00	0.00	0.00	0.00	0.00
Pedestrians	3.40	6.84	0.50	6.18	0.00	87.70	0.00	0.00	87.70
TOTAL	517.75	43.74	11.84	22.28	3.65	368.17	17.21	0.00	385.38

- 1 < = adjusted flow warning (upstream links/traffic streams are over-saturated)
- 1 * = Traffic Stream - Normal, Bus or Tram Stop or Delay weighting has been set to a value other than 100%
- 1 ^ = Traffic Stream - Normal, Bus or Tram Stop or Delay Path weighting has been set to a value other than 100%
- 1 + = average link/traffic stream excess queue is greater than 0
- 1 P.I. = PERFORMANCE INDEX

A3 - DO NOTHING 2029 D3 - DO NOTHING 2029*

Summary

Data Errors and Warnings

No errors or warnings

Run Summary

Analysis set used	Run start time	Run finish time	Modelling start time (HH:mm)	Network Cycle Time (s)	Performance Index (£ per hr)	Total network delay (Veh-hr/hr)	Highest DOS (%)	Item with highest DOS	Number of oversaturated items	Percentage of oversaturated items (%)	Item with worst signalised PRC	Item with worst unsignalised PRC	Item with worst over PR
3	19/08/2020 12:04:16	19/08/2020 12:04:17	08:00	120	459.10	30.89	83.03	C/2	0	0	C/2	Dx/1	C/

Analysis Set Details

Name	Description	Demand set	Include in report	Locked
DO NOTHING 2029		D3	✓	

Demand Set Details

Name	Description	Composite	Demand sets	Start time (HH:mm)	Locked
DO NOTHING 2029				08:00	

Arms and Traffic Streams

Arms

Arm	Name	Description	Traffic node
A	(untitled)		1
Ax	(untitled)		
B	(untitled)		1
Bx	(untitled)		
C	(untitled)		1
Cx	(untitled)		
D	(untitled)		1
Dx	(untitled)		
9			1
10			1
11			1
12			1

Traffic Streams

Arm	Traffic Stream	Name	Description	Auto length	Length (m)	Has Saturation Flow	Saturation flow source	Saturation flow (PCU/hr)	Is signal controlled	Is give way	Traffic type	Allow Nearside Turn On Red
A	1	(untitled)			20.00	✓	Sum of lanes	1800	✓		Normal	
	2				200.00	✓	Sum of lanes	1800	✓		Normal	
Ax	1	(untitled)		✓	182.93						Normal	
B	1	(untitled)			200.00	✓	Sum of lanes	1800	✓		Normal	
	2				18.00	✓	Sum of lanes	1800	✓		Normal	
Bx	1	(untitled)		✓	178.44						Normal	
C	1	(untitled)			200.00	✓	Sum of lanes	1800	✓		Normal	
	2				40.00	✓	Sum of lanes	1800	✓		Normal	
Cx	1	(untitled)		✓	194.82						Normal	
D	1	(untitled)			200.00	✓	Sum of lanes	1800	✓		Normal	
	2				30.00	✓	Sum of lanes	1800	✓		Normal	
Dx	1	(untitled)		✓	177.04						Normal	
9	1			✓	48.53						Normal	
10	1			✓	31.46						Normal	
11	1			✓	37.01						Normal	
12	1			✓	34.36						Normal	

Lanes

Arm	Traffic Stream	Lane	Name	Description	Use RR67	Saturation flow (PCU/hr)
A	1	1	(untitled)			1800
	2	1	(untitled)			1800
Ax	1	1	(untitled)			
B	1	1	(untitled)			1800
	2	1	(untitled)			1800
Bx	1	1	(untitled)			
C	1	1	(untitled)			1800
	2	1	(untitled)			1800
Cx	1	1	(untitled)			
D	1	1	(untitled)			1800
	2	1	(untitled)			1800
Dx	1	1	(untitled)			
9	1	1	(untitled)			
10	1	1	(untitled)			
11	1	1	(untitled)			
12	1	1	(untitled)			

Modelling

Arm	Traffic Stream	Traffic model	Stop weighting multiplier (%)	Delay weighting multiplier (%)	Assignment Cost Weighting (%)	Exclude from results calculation	Max queue storage (PCU)	Has queue limit	Has degree of saturation limit
(ALL)	(ALL)	NetworkDefault	100	100	100		0.00		

Modelling - Advanced

Arm	Traffic Stream	Initial queue (PCU)	Type of Vehicle-in-Service	Vehicle-in-Service	Type of random parameter	Random parameter	Auto cycle time	Cycle time
(ALL)	(ALL)	0.00	NetworkDefault	Not-Included	NetworkDefault	0.50	✓	120

Normal traffic - Modelling

Arm	Traffic Stream	Stop weighting (%)	Delay weighting (%)
(ALL)	(ALL)	100	100

Normal traffic - Advanced

Arm	Traffic Stream	Dispersion type for Normal Traffic
(ALL)	(ALL)	NetworkDefault

Flows

Arm	Traffic Stream	Total Flow (Veh/hr)	Normal Flow (Veh/hr)
A	1	296	296
	2	76	76
Ax	1	320	320
B	1	179	179
	2	39	39
Bx	1	761	761
C	1	199	199
	2	274	274
Cx	1	265	265
D	1	522	522
	2	40	40
Dx	1	279	279
9	1	372	372
10	1	218	218
11	1	473	473
12	1	562	562

Signals

Arm	Traffic Stream	Controller stream	Phase	Second phase enabled
A	1	1	D	
	2	1	C	
B	1	1	B	
	2	1	A	
C	1	1	D	
	2	1	C	
D	1	1	B	
	2	1	A	

Pedestrian Crossings

Pedestrian Crossings

Crossing	Name	Description	Traffic node	Allow walk on red	Crossing type	Length (m)	Cruise time (seconds)	Cruise speed (kph)
1	(untitled)		1		Farside	7.00	4.67	5.40
2	(untitled)		1		Farside	8.00	5.33	5.40
3	(untitled)		1		Farside	8.00	5.33	5.40
4	(untitled)		1		Farside	7.00	4.67	5.40

Pedestrian Crossings - Signals

Crossing	Controller stream	Phase	Second phase enabled
(ALL)	1	E	

Pedestrian Crossings - Sides

Crossing	Side	Saturation flow (Ped/hr)
(ALL)	(ALL)	11000

Pedestrian Crossings - Modelling

Crossing	Side	Delay weighting (%)	Assignment Cost Weighting (%)	Exclude from results calculation	Max queue storage (Ped)	Has queue limit	Has degree of saturation limit
(ALL)	(ALL)	100	100		0.00		

Local OD Matrix - Local Matrix: 1

Local Matrix Options

OD Matrix	Name	Use for point to point table	Auto calculate	Allocation mode	Allow paths past exit locations	Allow looped paths on arms	Allow looped paths on traffic nodes	Copy flows	Matrix to copy flows from	Limit paths by length	Path length limit multiplier	Limit paths by number	Path number limit
1	(untitled)	✓	✓	Path Equalisation	✓		✓			✓	1.25		

Normal Input Flows (Veh/hr)

	To							
	1	2	3	4	5	6	7	8
From 1	0	30	169	274	0	0	0	0
From 2	40	0	112	410	0	0	0	0
From 3	219	76	0	77	0	0	0	0
From 4	6	173	39	0	0	0	0	0
From 5	0	0	0	0	0	0	0	0
From 6	0	0	0	0	0	0	0	0
From 7	0	0	0	0	0	0	0	0
From 8	0	0	0	0	0	0	0	0

Bus Input Flows not shown as they are blank.

Tram Input Flows not shown as they are blank.

Pedestrian Input Flows (Veh/hr)

	To							
	1	2	3	4	5	6	7	8
From 1	0	0	0	0	0	0	0	0
From 2	0	0	0	0	0	0	0	0
From 3	0	0	0	0	0	0	0	0
From 4	0	0	0	0	0	0	0	0
From 5	0	0	0	0	0	50	50	0
From 6	0	0	0	0	50	0	0	50
From 7	0	0	0	0	50	0	0	50
From 8	0	0	0	0	0	50	50	0

Locations

OD Matrix	Location	Name	Entries	Exits	Colour
1	1	(untitled)	11/1	Cx/1	#0000FF
	2	(untitled)	12/1	Dx/1	#FF0000
	3	(untitled)	9/1	Ax/1	#00FF00
	4	(untitled)	10/1	Bx/1	#FFFF00
	5	(untitled)	3:2E, 1:1E	3:2X, 1:1X	#FF00FF
	6	(untitled)	2:1E, 1:2E	2:1X, 1:2X	#008000
	7	(untitled)	4:2E, 3:1E	4:2X, 3:1X	#FFA500
	8	(untitled)	4:1E, 2:2E	4:1X, 2:2X	#00FFFF

Normal Paths and Flows

OD Matrix	Path	Description	From location	To location	Path items	Allocation type	Normal Calculated Flow (Veh/hr)
1	9		4	3	10/1, B/2, Ax/1	Normal	39
	10		3	4	9/1, A/1, Bx/1	Normal	77
	11		1	3	11/1, C/1, Ax/1	Normal	169
	12		1	4	11/1, C/2, Bx/1	Normal	274
	13		3	1	9/1, A/1, Cx/1	Normal	219
	14		4	1	10/1, B/1, Cx/1	Normal	6
	15		2	3	12/1, D/1, Ax/1	Normal	112
	16		2	4	12/1, D/1, Bx/1	Normal	410
	19		3	2	9/1, A/2, Dx/1	Normal	76
	20		4	2	10/1, B/1, Dx/1	Normal	173
	43		2	1	12/1, D/2, Cx/1	Normal	40
	44		1	2	11/1, C/1, Dx/1	Normal	30

Pedestrian Paths and Flows

OD Matrix	Path	Description	From location	To location	Path items	Allocation type	Pedestrian calculated flow (Ped/hr)
1	17		8	7	4:1E, 4:2X	Normal	50
	18		8	6	2:2E, 2:1X	Normal	50
	22		5	7	3:2E, 3:1X	Normal	50
	23		5	6	1:1E, 1:2X	Normal	50
	34		6	8	2:1E, 2:2X	Normal	50
	35		6	5	1:2E, 1:1X	Normal	50
	41		7	8	4:2E, 4:1X	Normal	50
	42		7	5	3:1E, 3:2X	Normal	50

Signal Timings

Network Default: 120s cycle time; 120 steps

Controller Stream 1

Controller Stream	Name	Description	Use sequence	Cycle time source	Cycle time (s)
1	(untitled)		1	NetworkDefault	120

Controller Stream 1 - Properties

Controller Stream	Manufacturer name	Type	Model number	(Telephone) Line Number	Site number	Grid reference	Gaining delay type
1	Unspecified						Relative

Controller Stream 1 - Optimisation

Controller Stream	Allow offset optimisation	Allow green split optimisation	Optimisation level	Auto redistribute	Enable stage constraint
1	✓	✓	Offsets And Green Splits	✓	

Phases

Controller Stream	Phase	Name	Minimum green (s)	Maximum green (s)	Relative start displacement (s)	Relative end displacement (s)	Type	Blackout Time (s)
1	A	(untitled)	5	70	0	0	Traffic	
	B	(untitled)	7	70	0	0	Traffic	
	C	(untitled)	7	70	0	0	Traffic	
	D	(untitled)	7	70	0	0	Traffic	
	E	(untitled)	5	5	0	0	Pedestrian	0

Library Stages

Controller Stream	Library Stage	Phases in stage	User stage minimum (s)
1	1	A	1
	2	B	1
	3	C	1
	4	D	1
	5	E	1

Stage Sequences

Controller Stream	Sequence	Name	Multiple cycling	Stage IDs	Stage ends
1	1	(untitled)	Single	1, 2, 3, 4, 5	114, 40, 66, 94, 104

Intergreen Matrix for Controller Stream 1

		To				
		A	B	C	D	E
From	A		5	5	5	5
	B	5		5	5	5
	C	5	5		5	5
	D	5	5	5		5
	E	5	5	5	5	

Banned Stage transitions for Controller Stream 1

		To				
		1	2	3	4	5
From	1					
	2					
	3					
	4					
	5					

Interstage Matrix for Controller Stream 1

		To				
		1	2	3	4	5
From	1	0	5	5	5	5
	2	5	0	5	5	5
	3	5	5	0	5	5
	4	5	5	5	0	5
	5	5	5	5	5	0

Resultant Stages

Controller Stream	Resultant Stage	Is base stage	Library Stage ID	Phases in this stage	Stage start (s)	Stage end (s)	Stage duration (s)	User stage minimum (s)	Stage minimum (s)
1	1	✓	1	A	109	114	5	1	5
	2	✓	2	B	119	40	41	1	7
	3	✓	3	C	45	66	21	1	7
	4	✓	4	D	71	94	23	1	7
	5	✓	5	E	99	104	5	1	5

Resultant Phase Green Periods

Controller Stream	Phase	Green period	Is base green period	Start time (s)	End time (s)	Duration (s)
1	A	1	✓	109	114	5
	B	1	✓	119	40	41
	C	1	✓	45	66	21
	D	1	✓	71	94	23
	E	1	✓	99	104	5

Traffic Stream Green Times

Arm	Traffic Stream	Traffic Node	Controller Stream	Phase	Green Period 1		
					Start	End	Duration
A	1	1	1	D	71	94	23
A	2	1	1	C	45	66	21
B	1	1	1	B	119	40	41
B	2	1	1	A	109	114	5
C	1	1	1	D	71	94	23
C	2	1	1	C	45	66	21
D	1	1	1	B	119	40	41
D	2	1	1	A	109	114	5

Phase Timings Diagram for Controller Stream 1

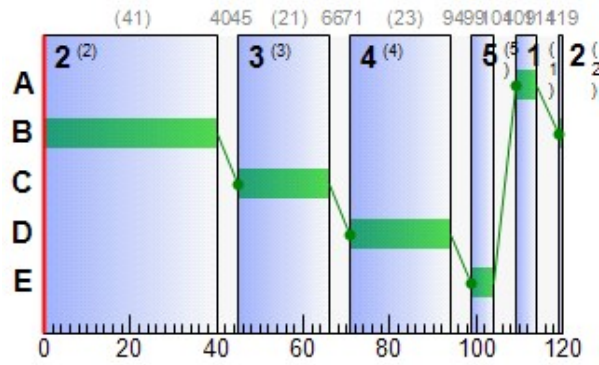

Stage Sequence Diagram for Controller Stream 1

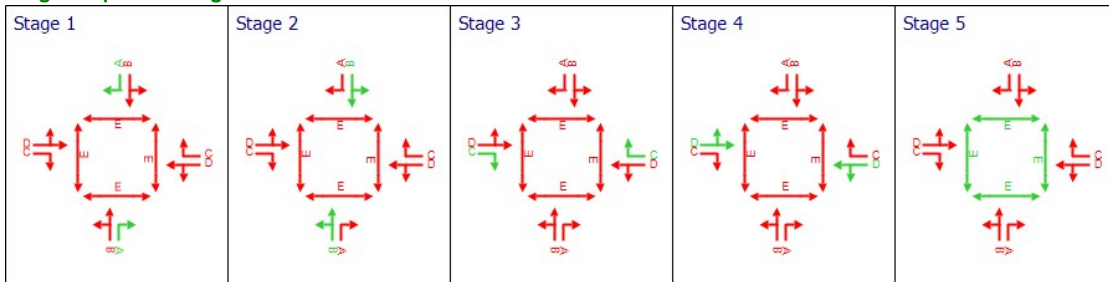

Resultant penalties

Time Segment	Controller stream	Phase min max penalty (£ per hr)	Intergreen broken penalty (£ per hr)	Stage constraint broken penalty (£ per hr)	Cost of controller stream penalties (£ per hr)
08:00-09:00	1	0.00	0.00	0.00	0.00

Traffic Stream Results

Traffic Stream Results: Vehicle summary

Time Segment	Arm	Traffic Stream	Degree of saturation (%)	Practical reserve capacity (%)	Calculated flow entering (Veh/hr)	Calculated sat flow (Veh/hr)	Actual green (s per cycle)	Mean Delay per Veh (s)	Mean max queue (Veh)	Utilised storage (%)	Weighted cost of delay (£ per hr)	Weighted cost of stops (£ per hr)	Performance Index (£ per hr)	
08:00-09:00	A	1	82	22	296	1800	23	67.36	11.13	320.07	78.65	4.12	82.77	
		2	23	334	76	1800	21	43.43	2.19	6.29	13.02	0.81	13.83	
	Ax	1	0	Unrestricted	320	Unrestricted	120	0.00	0.00	0.00	0.00	0.00	0.00	0.00
		2	0	Unrestricted	320	Unrestricted	120	0.00	0.00	0.00	0.00	0.00	0.00	0.00
	B	1	28	252	179	1800	41	29.29	4.33	12.46	20.68	1.61	22.29	
		2	43	131	39	1800	5	70.34	1.42	45.32	10.82	0.53	11.35	
	Bx	1	0	Unrestricted	761	Unrestricted	120	0.00	0.00	0.00	0.00	0.00	0.00	0.00
		2	0	Unrestricted	761	Unrestricted	120	0.00	0.00	0.00	0.00	0.00	0.00	0.00
	C	1	55	81	199	1800	23	49.29	6.25	17.98	38.69	2.33	41.01	
		2	83	20	274	1800	21	71.57	10.61	152.47	77.35	3.92	81.26	
	Cx	1	0	Unrestricted	265	Unrestricted	120	0.00	0.00	0.00	0.00	0.00	0.00	0.00
		2	0	Unrestricted	265	Unrestricted	120	0.00	0.00	0.00	0.00	0.00	0.00	0.00
	D	1	83	21	522	1800	41	48.85	17.71	50.92	100.58	6.56	107.14	
		2	44	125	40	1800	5	71.04	1.46	28.03	11.21	0.54	11.75	
Dx	1	0	Unrestricted	279	Unrestricted	120	0.00	0.00	0.00	0.00	0.00	0.00	0.00	
	2	0	Unrestricted	279	Unrestricted	120	0.00	0.00	0.00	0.00	0.00	0.00	0.00	
9	1	0	Unrestricted	372	Unrestricted	120	0.00	0.00	0.00	0.00	0.00	0.00	0.00	
10	1	0	Unrestricted	218	Unrestricted	120	0.00	0.00	0.00	0.00	0.00	0.00	0.00	
11	1	0	Unrestricted	473	Unrestricted	120	0.00	0.00	0.00	0.00	0.00	0.00	0.00	
12	1	0	Unrestricted	562	Unrestricted	120	0.00	0.00	0.00	0.00	0.00	0.00	0.00	

Traffic Stream Results: Flows and signals

Time Segment	Arm	Traffic Stream	Calculated flow entering (Veh/hr)	Calculated flow out (Veh/hr)	Flow discrepancy (Veh/hr)	Adjusted flow warning	Calculated sat flow (Veh/hr)	Calculated capacity (Veh/hr)	Degree of saturation (%)	DOS Threshold exceeded	Practical reserve capacity (%)	Mean modulus of error	Actual green (s per cycle)
08:00-09:00	A	1	296	296	0		1800	360	82		22	0.00	23
		2	76	76	0		1800	330	23		334	0.00	21
	Ax	1	320	320	0		Unrestricted	Unrestricted	0		Unrestricted	0.66	120
		2	320	320	0		Unrestricted	Unrestricted	0		Unrestricted	0.66	120
	B	1	179	179	0		1800	630	28		252	0.00	41
		2	39	39	0		1800	90	43		131	0.00	5
	Bx	1	761	761	0		Unrestricted	Unrestricted	0		Unrestricted	0.61	120
		2	761	761	0		Unrestricted	Unrestricted	0		Unrestricted	0.61	120
	C	1	199	199	0		1800	360	55		81	0.00	23
		2	274	274	0		1800	330	83		20	0.00	21
	Cx	1	265	265	0		Unrestricted	Unrestricted	0		Unrestricted	1.12	120
		2	265	265	0		Unrestricted	Unrestricted	0		Unrestricted	1.12	120
	D	1	522	522	0		1800	630	83		21	0.00	41
		2	40	40	0		1800	90	44		125	0.00	5
Dx	1	279	279	0		Unrestricted	Unrestricted	0		Unrestricted	0.77	120	
	2	279	279	0		Unrestricted	Unrestricted	0		Unrestricted	0.77	120	
9	1	372	372	0		Unrestricted	Unrestricted	0		Unrestricted	0.00	120	
10	1	218	218	0		Unrestricted	Unrestricted	0		Unrestricted	0.00	120	
11	1	473	473	0		Unrestricted	Unrestricted	0		Unrestricted	0.00	120	
12	1	562	562	0		Unrestricted	Unrestricted	0		Unrestricted	0.00	120	

Traffic Stream Results: Stops and delays

Time Segment	Arm	Traffic Stream	Mean Cruise Time per Veh (s)	Mean Delay per Veh (s)	Uniform delay (Veh-hr/hr)	Random plus oversat delay (Veh-hr/hr)	Weighted cost of delay (£ per hr)	Mean stops per Veh (%)	Uniform stops (Stops per hr)	Random stops (Stops per hr)	Weighted cost of stops (£ per hr)	
08:00-09:00	A	1	2.40	67.36	3.78	1.76	78.65	111.00	278.05	50.51	4.12	
		2	24.00	43.43	0.88	0.03	13.02	85.35	63.84	1.03	0.81	
	Ax	1	21.95	0.00	0.00	0.00	0.00	0.00	0.00	0.00	0.00	0.00
		2	24.00	29.29	1.40	0.06	20.68	71.58	126.44	1.69	1.61	
	B	1	2.16	70.34	0.60	0.16	10.82	107.76	37.32	4.71	0.53	
		2	21.41	0.00	0.00	0.00	0.00	0.00	0.00	0.00	0.00	
	Bx	1	24.00	49.29	2.39	0.34	38.69	93.20	175.46	10.01	2.33	
		2	4.80	71.57	3.59	1.85	77.35	114.01	259.50	52.89	3.92	
	C	1	23.38	0.00	0.00	0.00	0.00	0.00	0.00	0.00	0.00	
		2	24.00	48.85	5.18	1.91	100.58	100.18	467.31	55.64	6.56	
	Cx	1	3.60	71.04	0.62	0.17	11.21	108.28	38.27	5.04	0.54	
		2	21.24	0.00	0.00	0.00	0.00	0.00	0.00	0.00	0.00	
	D	1	5.82	0.00	0.00	0.00	0.00	0.00	0.00	0.00	0.00	
		2	3.78	0.00	0.00	0.00	0.00	0.00	0.00	0.00	0.00	
Dx	1	4.44	0.00	0.00	0.00	0.00	0.00	0.00	0.00	0.00		
	2	4.12	0.00	0.00	0.00	0.00	0.00	0.00	0.00	0.00		
9	1											
	2											
10	1											
	2											
11	1											
	2											
12	1											
	2											

Traffic Stream Results: Queues and blocking

Time Segment	Arm	Traffic Stream	Initial queue (Veh)	Mean max queue (Veh)	Max queue storage (Veh)	Utilised storage (%)	Average storage excess queue (Veh)	Average limit excess queue (Veh)	Excess queue penalty (£ per hr)	Wasted time starvation (s per cycle)	Wasted time blocking back (s per cycle)	Wasted time total (s per cycle)	Estimated blocking	
08:00-09:00	A	1	0.00	11.13	3.48	320.07	3.00	0.00	0.00	0.00	0.00	0.00		
		2	0.00	2.19	34.78	6.29	0.00	0.00	0.00	0.00	0.00	0.00		
	Ax	1	0.00	0.00	31.81	0.00	0.00	0.00	0.00	0.00	27.00	0.00	27.00	
		2	0.00	4.33	34.78	12.46	0.00	0.00	0.00	0.00	0.00	0.00	0.00	
	B	1	0.00	1.42	3.13	45.32	0.00	0.00	0.00	0.00	3.00	0.00	3.00	
		2	0.00	0.00	31.03	0.00	0.00	0.00	0.00	0.00	15.00	0.00	15.00	
	Bx	1	0.00	6.25	34.78	17.98	0.00	0.00	0.00	0.00	0.00	0.00	0.00	
		2	0.00	10.61	6.96	152.47	0.74	0.00	0.00	0.00	0.00	0.00	0.00	
	C	1	0.00	0.00	33.88	0.00	0.00	0.00	0.00	0.00	59.00	0.00	59.00	
		2	0.00	17.71	34.78	50.92	0.00	0.00	0.00	0.00	0.00	0.00	0.00	
	Cx	1	0.00	1.46	5.22	28.03	0.00	0.00	0.00	0.00	3.00	0.00	3.00	
		2	0.00	0.00	30.79	0.00	0.00	0.00	0.00	0.00	24.00	0.00	24.00	
	D	1	0.00	0.00	8.44	0.00	0.00	0.00	0.00	0.00	0.00	94.00	94.00	
		2	0.00	0.00	5.47	0.00	0.00	0.00	0.00	0.00	0.00	0.00	0.00	
9	1	0.00	0.00	6.44	0.00	0.00	0.00	0.00	0.00	0.00	48.00	48.00		
	2	0.00	0.00	5.97	0.00	0.00	0.00	0.00	0.00	0.00	0.00	0.00		
10	1													
	2													
11	1													
	2													
12	1													
	2													

Pedestrian Crossing Results

Pedestrian Crossings: Pedestrian summary

Time Segment	Crossing	Side	Degree of saturation (%)	Calculated Flow Entering (Ped/hr)	Calculated sat flow (Ped/hr)	Actual green (s per cycle)	Mean Delay Per Ped (s)	Mean max queue (Ped)	Weighted cost of delay (£ per hr)	Performance Index (£ per hr)
08:00-09:00	(ALL)	(ALL)	11	50	11000	5	55.58	1.60	10.96	10.96

Pedestrian Crossings: Flows and signals

Time Segment	Crossing	Side	Calculated flow entering (Ped/hr)	Calculated flow out (Ped/hr)	Flow discrepancy (Ped/hr)	Adjusted flow warning	Calculated sat flow (Ped/hr)	Calculated capacity (Ped/hr)	Degree of saturation (%)	DOS Threshold exceeded	Practical reserve capacity (%)	Mean modulus of error	Actual green (s per cycle)
08:00-09:00	(ALL)	(ALL)	50	50	0		11000	458	11		817	0.00	5

Pedestrian Crossings: Stops and delays

Time Segment	Crossing	Side	Mean Cruise Time per Ped (s)	Mean Delay per Ped (s)	Uniform delay (Ped-hr/hr)	Random plus oversat delay (Ped-hr/hr)	Weighted cost of delay (£ per hr)
08:00-09:00	1	1	5.67	55.58	0.77	0.00	10.96
		2	5.67	55.58	0.77	0.00	10.96
	2	1	6.33	55.58	0.77	0.00	10.96
		2	6.33	55.58	0.77	0.00	10.96
	3	1	6.33	55.58	0.77	0.00	10.96
		2	6.33	55.58	0.77	0.00	10.96
	4	1	5.67	55.58	0.77	0.00	10.96
		2	5.67	55.58	0.77	0.00	10.96

Pedestrian Crossings: Queues and blocking

Time Segment	Crossing	Side	Mean max queue (Ped)	Max queue storage (Ped)	Utilised storage (%)	Average storage excess queue (Ped)	Average limit excess queue (Ped)	Excess queue penalty (£ per hr)
08:00-09:00	(ALL)	(ALL)	1.60	10.00	15.97	0.00	0.00	0.00

Network Results

Network Results: Flows and signals

Time Segment	Calculated flow entering (Veh/hr)	Calculated flow out (Veh/hr)	Flow discrepancy (Veh/hr)	Adjusted flow warning	Degree of saturation (%)	DOS Threshold exceeded	Practical reserve capacity (%)	Actual green (s (per cycle))
08:00-09:00	5275	5275	0		83		20	1180

Network Results: Stops and delays

Time Segment	Mean Cruise Time per Veh (s)	Mean Delay per Veh (s)	Uniform delay (Veh-hr/hr)	Random plus oversat delay (Veh-hr/hr)	Weighted cost of delay (£ per hr)	Mean stops per Veh (%)	Uniform stops (Stops per hr)	Random stops (Stops per hr)	Weighted cost of stops (£ per hr)
08:00-09:00	13.45	21.08	24.61	6.28	438.69	30.86	1446.20	181.51	20.41

Network Results: Queues and blocking

Time Segment	Utilised storage (%)	Excess queue penalty (£ per hr)	Wasted time starvation (s (per cycle))	Wasted time blocking back (s (per cycle))	Wasted time total (s (per cycle))
08:00-09:00	320.07	0.00	131.00	142.00	273.00

Final Prediction Table

Traffic Stream Results

Arm	Traffic Stream	Name	Traffic node	SIGNALS		FLOWS		PERFORMANCE				PER PCU			QUEUES
				Controller stream	Phase	Calculated flow entering (Veh/hr)	Calculated sat flow (Veh/hr)	Actual green (s per cycle)	Wasted time total (s per cycle)	Degree of saturation (%)	Practical reserve capacity (%)	JourneyTime (s)	Mean Delay per Veh (s)	Mean stops per Veh (%)	Mean max queue (Veh)
A	1	(untitled)	1	1	D	296 <	1800	23	0.00	82	22	69.76	67.36	111.00	11.13 +
	2		1	1	C	76	1800	21	0.00	23	334	67.43	43.43	85.35	2.19
Ax	1	(untitled)				320	Unrestricted	120	27.00	0	Unrestricted	21.95	0.00	0.00	0.00
B	1	(untitled)	1	1	B	179	1800	41	0.00	28	252	53.29	29.29	71.58	4.33
	2		1	1	A	39	1800	5	3.00	43	131	72.50	70.34	107.76	1.42
Bx	1	(untitled)				761	Unrestricted	120	15.00	0	Unrestricted	21.41	0.00	0.00	0.00
C	1	(untitled)	1	1	D	199	1800	23	0.00	55	81	73.29	49.29	93.20	6.25
	2		1	1	C	274 <	1800	21	0.00	83	20	76.37	71.57	114.01	10.61 +
Cx	1	(untitled)				265	Unrestricted	120	59.00	0	Unrestricted	23.38	0.00	0.00	0.00
D	1	(untitled)	1	1	B	522	1800	41	0.00	83	21	72.85	48.85	100.18	17.71
	2		1	1	A	40	1800	5	3.00	44	125	74.64	71.04	108.28	1.46
Dx	1	(untitled)				279	Unrestricted	120	24.00	0	Unrestricted	21.24	0.00	0.00	0.00
9	1		1			372	Unrestricted	120	94.00	0	Unrestricted	5.82	0.00	0.00	0.00
10	1		1			218	Unrestricted	120	0.00	0	Unrestricted	3.78	0.00	0.00	0.00
11	1		1			473	Unrestricted	120	48.00	0	Unrestricted	4.44	0.00	0.00	0.00
12	1		1			562	Unrestricted	120	0.00	0	Unrestricted	4.12	0.00	0.00	0.00

Pedestrian Crossing Results

Pedestrian	Side	Name	Traffic node	SIGNALS		FLOWS		PERFORMANCE			PER PED		QUEUES	WEIGHTS	PEN
				Controller stream	Phase	Calculated Flow Entering (Ped/hr)	Calculated sat flow (Ped/hr)	Actual green (s per cycle)	Degree of saturation (%)	Practical reserve capacity (%)	JourneyTime (s)	Mean Delay per Ped (s)	Mean max queue (Ped)	Delay weighting (%)	Co tra pen (£ p
1	1	(untitled)	1	1	E	50	11000	5	11	817	61.25	55.58	1.60	100	0
	2	(untitled)	1	1	E	50	11000	5	11	817	61.25	55.58	1.60	100	0
2	1	(untitled)	1	1	E	50	11000	5	11	817	61.92	55.58	1.60	100	0
	2	(untitled)	1	1	E	50	11000	5	11	817	61.92	55.58	1.60	100	0
3	1	(untitled)	1	1	E	50	11000	5	11	817	61.92	55.58	1.60	100	0
	2	(untitled)	1	1	E	50	11000	5	11	817	61.92	55.58	1.60	100	0
4	1	(untitled)	1	1	E	50	11000	5	11	817	61.25	55.58	1.60	100	0
	2	(untitled)	1	1	E	50	11000	5	11	817	61.25	55.58	1.60	100	0

Network Results

	Distance travelled (PCU-km/hr)	Time spent (PCU-hr/hr)	Mean journey speed (kph)	Uniform delay (Veh-hr/hr)	Random plus oversat delay (Veh-hr/hr)	Weighted cost of delay (£ per hr)	Weighted cost of stops (£ per hr)	Excess queue penalty (£ per hr)	Performance Index (£ per hr)
Normal traffic	571.05	43.75	13.05	18.43	6.28	350.99	20.41	0.00	371.40
Bus	0.00	0.00	0.00	0.00	0.00	0.00	0.00	0.00	0.00
Tram	0.00	0.00	0.00	0.00	0.00	0.00	0.00	0.00	0.00
Pedestrians	3.40	6.84	0.50	6.18	0.00	87.70	0.00	0.00	87.70
TOTAL	574.45	50.60	11.35	24.61	6.28	438.69	20.41	0.00	459.10

- 1 < = adjusted flow warning (upstream links/traffic streams are over-saturated)
- 1 * = Traffic Stream - Normal, Bus or Tram Stop or Delay weighting has been set to a value other than 100%
- 1 ^ = Traffic Stream - Normal, Bus or Tram Stop or Delay Path weighting has been set to a value other than 100%
- 1 + = average link/traffic stream excess queue is greater than 0
- 1 P.I. = PERFORMANCE INDEX

A4 - DO NOTHING 2039

D4 - DO NOTHING 2039*

Summary

Data Errors and Warnings

No errors or warnings

Run Summary

Analysis set used	Run start time	Run finish time	Modelling start time (HH:mm)	Network Cycle Time (s)	Performance Index (£ per hr)	Total network delay (Veh-hr/hr)	Highest DOS (%)	Item with highest DOS	Number of oversaturated items	Percentage of oversaturated items (%)	Item with worst signalised PRC	Item with worst unsignalised PRC	Item with worst over PR
4	19/08/2020 12:04:24	19/08/2020 12:04:25	08:00	120	536.63	36.15	89.21	D/1	0	0	D/1	Dx/1	D/

Analysis Set Details

Name	Description	Demand set	Include in report	Locked
DO NOTHING 2039		D4	✓	

Demand Set Details

Name	Description	Composite	Demand sets	Start time (HH:mm)	Locked
DO NOTHING 2039				08:00	

Arms and Traffic Streams

Arms

Arm	Name	Description	Traffic node
A	(untitled)		1
Ax	(untitled)		
B	(untitled)		1
Bx	(untitled)		
C	(untitled)		1
Cx	(untitled)		
D	(untitled)		1
Dx	(untitled)		
9			1
10			1
11			1
12			1

Traffic Streams

Arm	Traffic Stream	Name	Description	Auto length	Length (m)	Has Saturation Flow	Saturation flow source	Saturation flow (PCU/hr)	Is signal controlled	Is give way	Traffic type	Allow Nearside Turn On Red
A	1	(untitled)			20.00	✓	Sum of lanes	1800	✓		Normal	
	2				200.00	✓	Sum of lanes	1800	✓		Normal	
Ax	1	(untitled)		✓	182.93						Normal	
B	1	(untitled)			200.00	✓	Sum of lanes	1800	✓		Normal	
	2				18.00	✓	Sum of lanes	1800	✓		Normal	
Bx	1	(untitled)		✓	178.44						Normal	
C	1	(untitled)			200.00	✓	Sum of lanes	1800	✓		Normal	
	2				40.00	✓	Sum of lanes	1800	✓		Normal	
Cx	1	(untitled)		✓	194.82						Normal	
D	1	(untitled)			200.00	✓	Sum of lanes	1800	✓		Normal	
	2				30.00	✓	Sum of lanes	1800	✓		Normal	
Dx	1	(untitled)		✓	177.04						Normal	
9	1			✓	48.53						Normal	
10	1			✓	31.46						Normal	
11	1			✓	37.01						Normal	
12	1			✓	34.36						Normal	

Lanes

Arm	Traffic Stream	Lane	Name	Description	Use RR67	Saturation flow (PCU/hr)
A	1	1	(untitled)			1800
	2	1	(untitled)			1800
Ax	1	1	(untitled)			
B	1	1	(untitled)			1800
	2	1	(untitled)			1800
Bx	1	1	(untitled)			
C	1	1	(untitled)			1800
	2	1	(untitled)			1800
Cx	1	1	(untitled)			
D	1	1	(untitled)			1800
	2	1	(untitled)			1800
Dx	1	1	(untitled)			
9	1	1	(untitled)			
10	1	1	(untitled)			
11	1	1	(untitled)			
12	1	1	(untitled)			

Modelling

Arm	Traffic Stream	Traffic model	Stop weighting multiplier (%)	Delay weighting multiplier (%)	Assignment Cost Weighting (%)	Exclude from results calculation	Max queue storage (PCU)	Has queue limit	Has degree of saturation limit
(ALL)	(ALL)	NetworkDefault	100	100	100		0.00		

Modelling - Advanced

Arm	Traffic Stream	Initial queue (PCU)	Type of Vehicle-in-Service	Vehicle-in-Service	Type of random parameter	Random parameter	Auto cycle time	Cycle time
(ALL)	(ALL)	0.00	NetworkDefault	Not-Included	NetworkDefault	0.50	✓	120

Normal traffic - Modelling

Arm	Traffic Stream	Stop weighting (%)	Delay weighting (%)
(ALL)	(ALL)	100	100

Normal traffic - Advanced

Arm	Traffic Stream	Dispersion type for Normal Traffic
(ALL)	(ALL)	NetworkDefault

Flows

Arm	Traffic Stream	Total Flow (Veh/hr)	Normal Flow (Veh/hr)
A	1	317	317
	2	82	82
Ax	1	342	342
B	1	192	192
	2	41	41
Bx	1	817	817
C	1	212	212
	2	293	293
Cx	1	283	283
D	1	562	562
	2	43	43
Dx	1	300	300
9	1	399	399
10	1	233	233
11	1	505	505
12	1	605	605

Signals

Arm	Traffic Stream	Controller stream	Phase	Second phase enabled
A	1	1	D	
	2	1	C	
B	1	1	B	
	2	1	A	
C	1	1	D	
	2	1	C	
D	1	1	B	
	2	1	A	

Pedestrian Crossings

Pedestrian Crossings

Crossing	Name	Description	Traffic node	Allow walk on red	Crossing type	Length (m)	Cruise time (seconds)	Cruise speed (kph)
1	(untitled)		1		Farside	7.00	4.67	5.40
2	(untitled)		1		Farside	8.00	5.33	5.40
3	(untitled)		1		Farside	8.00	5.33	5.40
4	(untitled)		1		Farside	7.00	4.67	5.40

Pedestrian Crossings - Signals

Crossing	Controller stream	Phase	Second phase enabled
(ALL)	1	E	

Pedestrian Crossings - Sides

Crossing	Side	Saturation flow (Ped/hr)
(ALL)	(ALL)	11000

Pedestrian Crossings - Modelling

Crossing	Side	Delay weighting (%)	Assignment Cost Weighting (%)	Exclude from results calculation	Max queue storage (Ped)	Has queue limit	Has degree of saturation limit
(ALL)	(ALL)	100	100		0.00		

Local OD Matrix - Local Matrix: 1

Local Matrix Options

OD Matrix	Name	Use for point to point table	Auto calculate	Allocation mode	Allow paths past exit locations	Allow looped paths on arms	Allow looped paths on traffic nodes	Copy flows	Matrix to copy flows from	Limit paths by length	Path length limit multiplier	Limit paths by number	Path number limit
1	(untitled)	✓	✓	Path Equalisation	✓		✓			✓	1.25		

Normal Input Flows (Veh/hr)

	To							
	1	2	3	4	5	6	7	8
From 1	0	32	180	293	0	0	0	0
2	43	0	121	441	0	0	0	0
3	234	82	0	83	0	0	0	0
4	6	186	41	0	0	0	0	0
5	0	0	0	0	0	0	0	0
6	0	0	0	0	0	0	0	0
7	0	0	0	0	0	0	0	0
8	0	0	0	0	0	0	0	0

Bus Input Flows not shown as they are blank.

Pedestrian Input Flows (Veh/hr)

	To							
	1	2	3	4	5	6	7	8
From 1	0	0	0	0	0	0	0	0
2	0	0	0	0	0	0	0	0
3	0	0	0	0	0	0	0	0
4	0	0	0	0	0	0	0	0
5	0	0	0	0	0	50	50	0
6	0	0	0	0	50	0	0	50
7	0	0	0	0	50	0	0	50
8	0	0	0	0	0	50	50	0

Locations

OD Matrix	Location	Name	Entries	Exits	Colour
1	1	(untitled)	11/1	Cx/1	#0000FF
	2	(untitled)	12/1	Dx/1	#FF0000
	3	(untitled)	9/1	Ax/1	#00FF00
	4	(untitled)	10/1	Bx/1	#FFFF00
	5	(untitled)	3:2E, 1:1E	3:2X, 1:1X	#FF00FF
	6	(untitled)	2:1E, 1:2E	2:1X, 1:2X	#008000
	7	(untitled)	4:2E, 3:1E	4:2X, 3:1X	#FFA500
	8	(untitled)	4:1E, 2:2E	4:1X, 2:2X	#00FFFF

Normal Paths and Flows

OD Matrix	Path	Description	From location	To location	Path items	Allocation type	Normal Calculated Flow (Veh/hr)
1	9		4	3	10/1, B/2, Ax/1	Normal	41
	10		3	4	9/1, A/1, Bx/1	Normal	83
	11		1	3	11/1, C/1, Ax/1	Normal	180
	12		1	4	11/1, C/2, Bx/1	Normal	293
	13		3	1	9/1, A/1, Cx/1	Normal	234
	14		4	1	10/1, B/1, Cx/1	Normal	6
	15		2	3	12/1, D/1, Ax/1	Normal	121
	16		2	4	12/1, D/1, Bx/1	Normal	441
	19		3	2	9/1, A/2, Dx/1	Normal	82
	20		4	2	10/1, B/1, Dx/1	Normal	186
	43		2	1	12/1, D/2, Cx/1	Normal	43
	44		1	2	11/1, C/1, Dx/1	Normal	32

Pedestrian Paths and Flows

OD Matrix	Path	Description	From location	To location	Path items	Allocation type	Pedestrian calculated flow (Ped/hr)
1	17		8	7	4:1E, 4:2X	Normal	50
	18		8	6	2:2E, 2:1X	Normal	50
	22		5	7	3:2E, 3:1X	Normal	50
	23		5	6	1:1E, 1:2X	Normal	50
	34		6	8	2:1E, 2:2X	Normal	50
	35		6	5	1:2E, 1:1X	Normal	50
	41		7	8	4:2E, 4:1X	Normal	50
	42		7	5	3:1E, 3:2X	Normal	50

Signal Timings

Network Default: 120s cycle time; 120 steps

Controller Stream 1

Controller Stream	Name	Description	Use sequence	Cycle time source	Cycle time (s)
1	(untitled)		1	NetworkDefault	120

Controller Stream 1 - Properties

Controller Stream	Manufacturer name	Type	Model number	(Telephone) Line Number	Site number	Grid reference	Gaining delay type
1	Unspecified						Relative

Controller Stream 1 - Optimisation

Controller Stream	Allow offset optimisation	Allow green split optimisation	Optimisation level	Auto redistribute	Enable stage constraint
1	✓	✓	Offsets And Green Splits	✓	

Phases

Controller Stream	Phase	Name	Minimum green (s)	Maximum green (s)	Relative start displacement (s)	Relative end displacement (s)	Type	Blackout Time (s)
1	A	(untitled)	5	70	0	0	Traffic	
	B	(untitled)	7	70	0	0	Traffic	
	C	(untitled)	7	70	0	0	Traffic	
	D	(untitled)	7	70	0	0	Traffic	
	E	(untitled)	5	5	0	0	Pedestrian	0

Library Stages

Controller Stream	Library Stage	Phases in stage	User stage minimum (s)
1	1	A	1
	2	B	1
	3	C	1
	4	D	1
	5	E	1

Stage Sequences

Controller Stream	Sequence	Name	Multiple cycling	Stage IDs	Stage ends
1	1	(untitled)	Single	1, 2, 3, 4, 5	114, 40, 66, 94, 104

Intergreen Matrix for Controller Stream 1

		To				
		A	B	C	D	E
From	A		5	5	5	5
	B	5		5	5	5
	C	5	5		5	5
	D	5	5	5		5
	E	5	5	5	5	

Banned Stage transitions for Controller Stream 1

		To				
		1	2	3	4	5
From	1					
	2					
	3					
	4					
	5					

Interstage Matrix for Controller Stream 1

		To				
		1	2	3	4	5
From	1	0	5	5	5	5
	2	5	0	5	5	5
	3	5	5	0	5	5
	4	5	5	5	0	5
	5	5	5	5	5	0

Resultant Stages

Controller Stream	Resultant Stage	Is base stage	Library Stage ID	Phases in this stage	Stage start (s)	Stage end (s)	Stage duration (s)	User stage minimum (s)	Stage minimum (s)
1	1	✓	1	A	109	114	5	1	5
	2	✓	2	B	119	40	41	1	7
	3	✓	3	C	45	66	21	1	7
	4	✓	4	D	71	94	23	1	7
	5	✓	5	E	99	104	5	1	5

Resultant Phase Green Periods

Controller Stream	Phase	Green period	Is base green period	Start time (s)	End time (s)	Duration (s)
1	A	1	✓	109	114	5
	B	1	✓	119	40	41
	C	1	✓	45	66	21
	D	1	✓	71	94	23
	E	1	✓	99	104	5

Traffic Stream Green Times

Arm	Traffic Stream	Traffic Node	Controller Stream	Phase	Green Period 1		
					Start	End	Duration
A	1	1	1	D	71	94	23
A	2	1	1	C	45	66	21
B	1	1	1	B	119	40	41
B	2	1	1	A	109	114	5
C	1	1	1	D	71	94	23
C	2	1	1	C	45	66	21
D	1	1	1	B	119	40	41
D	2	1	1	A	109	114	5

Phase Timings Diagram for Controller Stream 1

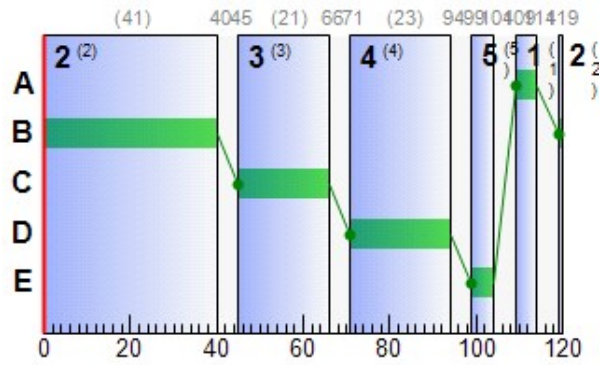

Stage Sequence Diagram for Controller Stream 1

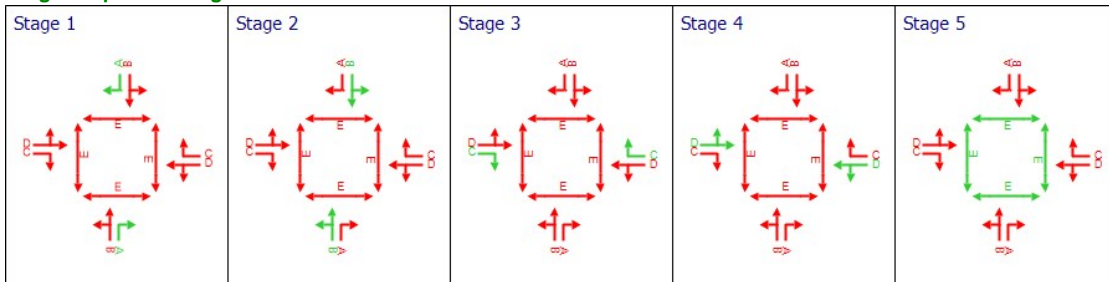

Resultant penalties

Time Segment	Controller stream	Phase min max penalty (£ per hr)	Intergreen broken penalty (£ per hr)	Stage constraint broken penalty (£ per hr)	Cost of controller stream penalties (£ per hr)
08:00-09:00	1	0.00	0.00	0.00	0.00

Traffic Stream Results

Traffic Stream Results: Vehicle summary

Time Segment	Arm	Traffic Stream	Degree of saturation (%)	Practical reserve capacity (%)	Calculated flow entering (Veh/hr)	Calculated sat flow (Veh/hr)	Actual green (s per cycle)	Mean Delay per Veh (s)	Mean max queue (Veh)	Utilised storage (%)	Weighted cost of delay (£ per hr)	Weighted cost of stops (£ per hr)	Performance Index (£ per hr)	
08:00-09:00	A	1	88	14	317	1800	23	78.13	12.99	373.45	97.69	4.77	102.46	
		2	25	302	82	1800	21	43.75	2.36	6.80	14.15	0.88	15.03	
	Ax	1	0	Unrestricted	342	Unrestricted	120	0.00	0.00	0.00	0.00	0.00	0.00	0.00
		2	0	Unrestricted	342	Unrestricted	120	0.00	0.00	0.00	0.00	0.00	0.00	0.00
	B	1	30	228	192	1800	41	29.63	4.71	13.53	22.44	1.74	24.19	
		2	46	120	41	1800	5	71.76	1.51	48.14	11.61	0.56	12.16	
	Bx	1	0	Unrestricted	817	Unrestricted	120	0.00	0.00	0.00	0.00	0.00	0.00	0.00
		2	0	Unrestricted	817	Unrestricted	120	0.00	0.00	0.00	0.00	0.00	0.00	0.00
	C	1	59	70	212	1800	23	50.60	6.78	19.48	42.31	2.52	44.83	
		2	89	13	293	1800	21	83.64	12.44	178.82	96.66	4.54	101.20	
	Cx	1	0	Unrestricted	283	Unrestricted	120	0.00	0.00	0.00	0.00	0.00	0.00	0.00
		2	0	Unrestricted	283	Unrestricted	120	0.00	0.00	0.00	0.00	0.00	0.00	0.00
	D	1	89	12	562	1800	41	57.89	20.92	60.16	128.34	7.70	136.04	
		2	48	109	43	1800	5	73.28	1.60	30.63	12.43	0.59	13.02	
Dx	1	0	Unrestricted	300	Unrestricted	120	0.00	0.00	0.00	0.00	0.00	0.00	0.00	
	2	0	Unrestricted	300	Unrestricted	120	0.00	0.00	0.00	0.00	0.00	0.00	0.00	
9	1	0	Unrestricted	399	Unrestricted	120	0.00	0.00	0.00	0.00	0.00	0.00	0.00	
10	1	0	Unrestricted	233	Unrestricted	120	0.00	0.00	0.00	0.00	0.00	0.00	0.00	
11	1	0	Unrestricted	505	Unrestricted	120	0.00	0.00	0.00	0.00	0.00	0.00	0.00	
12	1	0	Unrestricted	605	Unrestricted	120	0.00	0.00	0.00	0.00	0.00	0.00	0.00	

Traffic Stream Results: Flows and signals

Time Segment	Arm	Traffic Stream	Calculated flow entering (Veh/hr)	Calculated flow out (Veh/hr)	Flow discrepancy (Veh/hr)	Adjusted flow warning	Calculated sat flow (Veh/hr)	Calculated capacity (Veh/hr)	Degree of saturation (%)	DOS Threshold exceeded	Practical reserve capacity (%)	Mean modulus of error	Actual green (s per cycle)
08:00-09:00	A	1	317	317	0		1800	360	88		14	0.00	23
		2	82	82	0		1800	330	25		302	0.00	21
	Ax	1	342	342	0		Unrestricted	Unrestricted	0		Unrestricted	0.63	120
		2	342	342	0		Unrestricted	Unrestricted	0		Unrestricted	0.63	120
	B	1	192	192	0		1800	630	30		228	0.00	41
		2	41	41	0		1800	90	46		120	0.00	5
	Bx	1	817	817	0		Unrestricted	Unrestricted	0		Unrestricted	0.58	120
		2	817	817	0		Unrestricted	Unrestricted	0		Unrestricted	0.58	120
	C	1	212	212	0		1800	360	59		70	0.00	23
		2	293	293	0		1800	330	89		13	0.00	21
	Cx	1	283	283	0		Unrestricted	Unrestricted	0		Unrestricted	1.11	120
		2	283	283	0		Unrestricted	Unrestricted	0		Unrestricted	1.11	120
	D	1	562	562	0		1800	630	89		12	0.00	41
		2	43	43	0		1800	90	48		109	0.00	5
Dx	1	300	300	0		Unrestricted	Unrestricted	0		Unrestricted	0.77	120	
	2	300	300	0		Unrestricted	Unrestricted	0		Unrestricted	0.77	120	
9	1	399	399	0		Unrestricted	Unrestricted	0		Unrestricted	0.00	120	
10	1	233	233	0		Unrestricted	Unrestricted	0		Unrestricted	0.00	120	
11	1	505	505	0		Unrestricted	Unrestricted	0		Unrestricted	0.00	120	
12	1	605	605	0		Unrestricted	Unrestricted	0		Unrestricted	0.00	120	

Traffic Stream Results: Stops and delays

Time Segment	Arm	Traffic Stream	Mean Cruise Time per Veh (s)	Mean Delay per Veh (s)	Uniform delay (Veh-hr/hr)	Random plus oversat delay (Veh-hr/hr)	Weighted cost of delay (£ per hr)	Mean stops per Veh (%)	Uniform stops (Stops per hr)	Random stops (Stops per hr)	Weighted cost of stops (£ per hr)	
08:00-09:00	A	1	2.40	78.13	4.10	2.77	97.69	120.07	302.62	78.01	4.77	
		2	24.00	43.75	0.96	0.04	14.15	85.51	68.89	1.22	0.88	
	Ax	1	21.95	0.00	0.00	0.00	0.00	0.00	0.00	0.00	0.00	0.00
		2	24.00	29.63	1.51	0.07	22.44	72.37	136.95	2.00	1.74	
	B	1	24.00	29.63	1.51	0.07	22.44	72.37	136.95	2.00	1.74	
		2	2.16	71.76	0.63	0.19	11.61	108.82	39.23	5.39	0.56	
	Bx	1	21.41	0.00	0.00	0.00	0.00	0.00	0.00	0.00	0.00	0.00
		2	24.00	50.60	2.56	0.42	42.31	94.79	188.65	12.30	2.52	
	C	1	24.00	50.60	2.56	0.42	42.31	94.79	188.65	12.30	2.52	
		2	4.80	83.64	3.89	2.92	96.66	123.50	280.57	81.29	4.54	
	Cx	1	23.38	0.00	0.00	0.00	0.00	0.00	0.00	0.00	0.00	0.00
		2	24.00	57.89	5.75	3.28	128.34	109.33	520.11	94.31	7.70	
	D	1	24.00	57.89	5.75	3.28	128.34	109.33	520.11	94.31	7.70	
		2	3.60	73.28	0.66	0.21	12.43	109.96	41.14	6.14	0.59	
Dx	1	21.24	0.00	0.00	0.00	0.00	0.00	0.00	0.00	0.00	0.00	
	2	5.82	0.00	0.00	0.00	0.00	0.00	0.00	0.00	0.00	0.00	
9	1	5.82	0.00	0.00	0.00	0.00	0.00	0.00	0.00	0.00	0.00	
10	1	3.78	0.00	0.00	0.00	0.00	0.00	0.00	0.00	0.00	0.00	
11	1	4.44	0.00	0.00	0.00	0.00	0.00	0.00	0.00	0.00	0.00	
12	1	4.12	0.00	0.00	0.00	0.00	0.00	0.00	0.00	0.00	0.00	

Traffic Stream Results: Queues and blocking

Time Segment	Arm	Traffic Stream	Initial queue (Veh)	Mean max queue (Veh)	Max queue storage (Veh)	Utilised storage (%)	Average storage excess queue (Veh)	Average limit excess queue (Veh)	Excess queue penalty (£ per hr)	Wasted time starvation (s per cycle)	Wasted time blocking back (s per cycle)	Wasted time total (s per cycle)	Estimated blocking
08:00-09:00	A	1	0.00	12.99	3.48	373.45	4.32	0.00	0.00	0.00	0.00	0.00	
		2	0.00	2.36	34.78	6.80	0.00	0.00	0.00	0.00	0.00	0.00	
	Ax	1	0.00	0.00	31.81	0.00	0.00	0.00	0.00	0.00	24.00	0.00	24.00
		2	0.00	4.71	34.78	13.53	0.00	0.00	0.00	0.00	0.00	0.00	0.00
	B	1	0.00	4.71	34.78	13.53	0.00	0.00	0.00	0.00	0.00	0.00	0.00
		2	0.00	1.51	3.13	48.14	0.00	0.00	0.00	0.00	3.00	0.00	3.00
	Bx	1	0.00	0.00	31.03	0.00	0.00	0.00	0.00	0.00	14.00	0.00	14.00
		2	0.00	6.78	34.78	19.48	0.00	0.00	0.00	0.00	0.00	0.00	0.00
	C	1	0.00	6.78	34.78	19.48	0.00	0.00	0.00	0.00	0.00	0.00	0.00
		2	0.00	12.44	6.96	178.82	1.56	0.00	0.00	0.00	0.00	0.00	0.00
	Cx	1	0.00	0.00	33.88	0.00	0.00	0.00	0.00	0.00	59.00	0.00	59.00
		2	0.00	20.92	34.78	60.16	0.00	0.00	0.00	0.00	0.00	0.00	0.00
	D	1	0.00	0.00	30.79	0.00	0.00	0.00	0.00	0.00	24.00	0.00	24.00
		2	0.00	1.60	5.22	30.63	0.00	0.00	0.00	0.00	3.00	0.00	3.00
Dx	1	0.00	0.00	30.79	0.00	0.00	0.00	0.00	0.00	24.00	0.00	24.00	
	2	0.00	0.00	8.44	0.00	0.00	0.00	0.00	0.00	0.00	109.00	109.00	
9	1	0.00	0.00	8.44	0.00	0.00	0.00	0.00	0.00	0.00	109.00	109.00	
10	1	0.00	0.00	5.47	0.00	0.00	0.00	0.00	0.00	0.00	0.00	0.00	
11	1	0.00	0.00	6.44	0.00	0.00	0.00	0.00	0.00	0.00	68.00	68.00	
12	1	0.00	0.00	5.97	0.00	0.00	0.00	0.00	0.00	0.00	0.00	0.00	

Pedestrian Crossing Results

Pedestrian Crossings: Pedestrian summary

Time Segment	Crossing	Side	Degree of saturation (%)	Calculated Flow Entering (Ped/hr)	Calculated sat flow (Ped/hr)	Actual green (s per cycle)	Mean Delay Per Ped (s)	Mean max queue (Ped)	Weighted cost of delay (£ per hr)	Performance Index (£ per hr)
08:00-09:00	(ALL)	(ALL)	11	50	11000	5	55.58	1.60	10.96	10.96

Pedestrian Crossings: Flows and signals

Time Segment	Crossing	Side	Calculated flow entering (Ped/hr)	Calculated flow out (Ped/hr)	Flow discrepancy (Ped/hr)	Adjusted flow warning	Calculated sat flow (Ped/hr)	Calculated capacity (Ped/hr)	Degree of saturation (%)	DOS Threshold exceeded	Practical reserve capacity (%)	Mean modulus of error	Actual green (s per cycle)
08:00-09:00	(ALL)	(ALL)	50	50	0		11000	458	11		817	0.00	5

Pedestrian Crossings: Stops and delays

Time Segment	Crossing	Side	Mean Cruise Time per Ped (s)	Mean Delay per Ped (s)	Uniform delay (Ped-hr/hr)	Random plus oversat delay (Ped-hr/hr)	Weighted cost of delay (£ per hr)
08:00-09:00	1	1	5.67	55.58	0.77	0.00	10.96
		2	5.67	55.58	0.77	0.00	10.96
	2	1	6.33	55.58	0.77	0.00	10.96
		2	6.33	55.58	0.77	0.00	10.96
	3	1	6.33	55.58	0.77	0.00	10.96
		2	6.33	55.58	0.77	0.00	10.96
	4	1	5.67	55.58	0.77	0.00	10.96
		2	5.67	55.58	0.77	0.00	10.96

Pedestrian Crossings: Queues and blocking

Time Segment	Crossing	Side	Mean max queue (Ped)	Max queue storage (Ped)	Utilised storage (%)	Average storage excess queue (Ped)	Average limit excess queue (Ped)	Excess queue penalty (£ per hr)
08:00-09:00	(ALL)	(ALL)	1.60	10.00	15.97	0.00	0.00	0.00

Network Results

Network Results: Flows and signals

Time Segment	Calculated flow entering (Veh/hr)	Calculated flow out (Veh/hr)	Flow discrepancy (Veh/hr)	Adjusted flow warning	Degree of saturation (%)	DOS Threshold exceeded	Practical reserve capacity (%)	Actual green (s (per cycle))
08:00-09:00	5626	5626	0		89		12	1180

Network Results: Stops and delays

Time Segment	Mean Cruise Time per Veh (s)	Mean Delay per Veh (s)	Uniform delay (Veh-hr/hr)	Random plus oversat delay (Veh-hr/hr)	Weighted cost of delay (£ per hr)	Mean stops per Veh (%)	Uniform stops (Stops per hr)	Random stops (Stops per hr)	Weighted cost of stops (£ per hr)
08:00-09:00	13.49	23.13	26.25	9.90	513.32	33.04	1578.16	280.67	23.31

Network Results: Queues and blocking

Time Segment	Utilised storage (%)	Excess queue penalty (£ per hr)	Wasted time starvation (s (per cycle))	Wasted time blocking back (s (per cycle))	Wasted time total (s (per cycle))
08:00-09:00	373.45	0.00	127.00	177.00	304.00

Final Prediction Table

Traffic Stream Results

Arm	Traffic Stream	Name	Traffic node	SIGNALS		FLOWS		PERFORMANCE				PER PCU			QUEUES
				Controller stream	Phase	Calculated flow entering (Veh/hr)	Calculated sat flow (Veh/hr)	Actual green (s per cycle)	Wasted time total (s per cycle)	Degree of saturation (%)	Practical reserve capacity (%)	JourneyTime (s)	Mean Delay per Veh (s)	Mean stops per Veh (%)	Mean max queue (Veh)
A	1	(untitled)	1	1	D	317 <	1800	23	0.00	88	14	80.53	78.13	120.07	12.99 +
	2		1	1	C	82	1800	21	0.00	25	302	67.75	43.75	85.51	2.36
Ax	1	(untitled)				342	Unrestricted	120	24.00	0	Unrestricted	21.95	0.00	0.00	0.00
B	1	(untitled)	1	1	B	192	1800	41	0.00	30	228	53.63	29.63	72.37	4.71
	2		1	1	A	41	1800	5	3.00	46	120	73.92	71.76	108.82	1.51
Bx	1	(untitled)				817	Unrestricted	120	14.00	0	Unrestricted	21.41	0.00	0.00	0.00
C	1	(untitled)	1	1	D	212	1800	23	0.00	59	70	74.60	50.60	94.79	6.78
	2		1	1	C	293 <	1800	21	0.00	89	13	88.44	83.64	123.50	12.44 +
Cx	1	(untitled)				283	Unrestricted	120	59.00	0	Unrestricted	23.38	0.00	0.00	0.00
D	1	(untitled)	1	1	B	562	1800	41	0.00	89	12	81.89	57.89	109.33	20.92
	2		1	1	A	43	1800	5	3.00	48	109	76.88	73.28	109.96	1.60
Dx	1	(untitled)				300	Unrestricted	120	24.00	0	Unrestricted	21.24	0.00	0.00	0.00
9	1		1			399	Unrestricted	120	109.00	0	Unrestricted	5.82	0.00	0.00	0.00
10	1		1			233	Unrestricted	120	0.00	0	Unrestricted	3.78	0.00	0.00	0.00
11	1		1			505	Unrestricted	120	68.00	0	Unrestricted	4.44	0.00	0.00	0.00
12	1		1			605	Unrestricted	120	0.00	0	Unrestricted	4.12	0.00	0.00	0.00

Pedestrian Crossing Results

Pedestrian	Side	Name	Traffic node	SIGNALS		FLOWS		PERFORMANCE			PER PED		QUEUES	WEIGHTS	PEN
				Controller stream	Phase	Calculated Flow Entering (Ped/hr)	Calculated sat flow (Ped/hr)	Actual green (s per cycle)	Degree of saturation (%)	Practical reserve capacity (%)	JourneyTime (s)	Mean Delay per Ped (s)	Mean max queue (Ped)	Delay weighting (%)	Co tra pen (£ p
1	1	(untitled)	1	1	E	50	11000	5	11	817	61.25	55.58	1.60	100	0
	2	(untitled)	1	1	E	50	11000	5	11	817	61.25	55.58	1.60	100	0
2	1	(untitled)	1	1	E	50	11000	5	11	817	61.92	55.58	1.60	100	0
	2	(untitled)	1	1	E	50	11000	5	11	817	61.92	55.58	1.60	100	0
3	1	(untitled)	1	1	E	50	11000	5	11	817	61.92	55.58	1.60	100	0
	2	(untitled)	1	1	E	50	11000	5	11	817	61.92	55.58	1.60	100	0
4	1	(untitled)	1	1	E	50	11000	5	11	817	61.25	55.58	1.60	100	0
	2	(untitled)	1	1	E	50	11000	5	11	817	61.25	55.58	1.60	100	0

Network Results

	Distance travelled (PCU-km/hr)	Time spent (PCU-hr/hr)	Mean journey speed (kph)	Uniform delay (Veh-hr/hr)	Random plus oversat delay (Veh-hr/hr)	Weighted cost of delay (£ per hr)	Weighted cost of stops (£ per hr)	Excess queue penalty (£ per hr)	Performance Index (£ per hr)
Normal traffic	612.45	50.39	12.15	20.08	9.90	425.63	23.31	0.00	448.93
Bus	0.00	0.00	0.00	0.00	0.00	0.00	0.00	0.00	0.00
Tram	0.00	0.00	0.00	0.00	0.00	0.00	0.00	0.00	0.00
Pedestrians	3.40	6.84	0.50	6.18	0.00	87.70	0.00	0.00	87.70
TOTAL	615.85	57.23	10.76	26.25	9.90	513.32	23.31	0.00	536.63

- 1 < = adjusted flow warning (upstream links/traffic streams are over-saturated)
- 1 * = Traffic Stream - Normal, Bus or Tram Stop or Delay weighting has been set to a value other than 100%
- 1 ^ = Traffic Stream - Normal, Bus or Tram Stop or Delay Path weighting has been set to a value other than 100%
- 1 + = average link/traffic stream excess queue is greater than 0
- 1 P.I. = PERFORMANCE INDEX

A5 - DO SOMETHING 2024 D5 - DO SOMETHING 2024*

Summary

Data Errors and Warnings

No errors or warnings

Run Summary

Analysis set used	Run start time	Run finish time	Modelling start time (HH:mm)	Network Cycle Time (s)	Performance Index (£ per hr)	Total network delay (Veh-hr/hr)	Highest DOS (%)	Item with highest DOS	Number of oversaturated items	Percentage of oversaturated items (%)	Item with worst signalised PRC	Item with worst unsignalised PRC	Item with worst over PR
5	19/08/2020 12:04:19	19/08/2020 12:04:20	08:00	120	417.56	28.09	78.06	C/2	0	0	C/2	Dx/1	C/

Analysis Set Details

Name	Description	Demand set	Include in report	Locked
DO SOMETHING 2024		D5	✓	

Demand Set Details

Name	Description	Composite	Demand sets	Start time (HH:mm)	Locked
DO SOMETHING 2024				08:00	

Arms and Traffic Streams

Arms

Arm	Name	Description	Traffic node
A	(untitled)		1
Ax	(untitled)		
B	(untitled)		1
Bx	(untitled)		
C	(untitled)		1
Cx	(untitled)		
D	(untitled)		1
Dx	(untitled)		
9			1
10			1
11			1
12			1

Traffic Streams

Arm	Traffic Stream	Name	Description	Auto length	Length (m)	Has Saturation Flow	Saturation flow source	Saturation flow (PCU/hr)	Is signal controlled	Is give way	Traffic type	Allow Nearside Turn On Red
A	1	(untitled)			20.00	✓	Sum of lanes	1800	✓		Normal	
	2				200.00	✓	Sum of lanes	1800	✓		Normal	
Ax	1	(untitled)		✓	182.93						Normal	
B	1	(untitled)			200.00	✓	Sum of lanes	1800	✓		Normal	
	2				18.00	✓	Sum of lanes	1800	✓		Normal	
Bx	1	(untitled)		✓	178.44						Normal	
C	1	(untitled)			200.00	✓	Sum of lanes	1800	✓		Normal	
	2				40.00	✓	Sum of lanes	1800	✓		Normal	
Cx	1	(untitled)		✓	194.82						Normal	
D	1	(untitled)			200.00	✓	Sum of lanes	1800	✓		Normal	
	2				30.00	✓	Sum of lanes	1800	✓		Normal	
Dx	1	(untitled)		✓	177.04						Normal	
9	1			✓	48.53						Normal	
10	1			✓	31.46						Normal	
11	1			✓	37.01						Normal	
12	1			✓	34.36						Normal	

Lanes

Arm	Traffic Stream	Lane	Name	Description	Use RR67	Saturation flow (PCU/hr)
A	1	1	(untitled)			1800
	2	1	(untitled)			1800
Ax	1	1	(untitled)			
B	1	1	(untitled)			1800
	2	1	(untitled)			1800
Bx	1	1	(untitled)			
C	1	1	(untitled)			1800
	2	1	(untitled)			1800
Cx	1	1	(untitled)			
D	1	1	(untitled)			1800
	2	1	(untitled)			1800
Dx	1	1	(untitled)			
9	1	1	(untitled)			
10	1	1	(untitled)			
11	1	1	(untitled)			
12	1	1	(untitled)			

Modelling

Arm	Traffic Stream	Traffic model	Stop weighting multiplier (%)	Delay weighting multiplier (%)	Assignment Cost Weighting (%)	Exclude from results calculation	Max queue storage (PCU)	Has queue limit	Has degree of saturation limit
(ALL)	(ALL)	NetworkDefault	100	100	100		0.00		

Modelling - Advanced

Arm	Traffic Stream	Initial queue (PCU)	Type of Vehicle-in-Service	Vehicle-in-Service	Type of random parameter	Random parameter	Auto cycle time	Cycle time
(ALL)	(ALL)	0.00	NetworkDefault	Not-Included	NetworkDefault	0.50	✓	120

Normal traffic - Modelling

Arm	Traffic Stream	Stop weighting (%)	Delay weighting (%)
(ALL)	(ALL)	100	100

Normal traffic - Advanced

Arm	Traffic Stream	Dispersion type for Normal Traffic
(ALL)	(ALL)	NetworkDefault

Flows

Arm	Traffic Stream	Total Flow (Veh/hr)	Normal Flow (Veh/hr)
A	1	268	268
	2	70	70
Ax	1	312	312
B	1	164	164
	2	35	35
Bx	1	728	728
C	1	200	200
	2	281	281
Cx	1	236	236
D	1	479	479
	2	34	34
Dx	1	255	255
9	1	338	338
10	1	199	199
11	1	481	481
12	1	513	513

Signals

Arm	Traffic Stream	Controller stream	Phase	Second phase enabled
A	1	1	D	
	2	1	C	
B	1	1	B	
	2	1	A	
C	1	1	D	
	2	1	C	
D	1	1	B	
	2	1	A	

Pedestrian Crossings

Pedestrian Crossings

Crossing	Name	Description	Traffic node	Allow walk on red	Crossing type	Length (m)	Cruise time (seconds)	Cruise speed (kph)
1	(untitled)		1		Farside	7.00	4.67	5.40
2	(untitled)		1		Farside	8.00	5.33	5.40
3	(untitled)		1		Farside	8.00	5.33	5.40
4	(untitled)		1		Farside	7.00	4.67	5.40

Pedestrian Crossings - Signals

Crossing	Controller stream	Phase	Second phase enabled
(ALL)	1	E	

Pedestrian Crossings - Sides

Crossing	Side	Saturation flow (Ped/hr)
(ALL)	(ALL)	11000

Pedestrian Crossings - Modelling

Crossing	Side	Delay weighting (%)	Assignment Cost Weighting (%)	Exclude from results calculation	Max queue storage (Ped)	Has queue limit	Has degree of saturation limit
(ALL)	(ALL)	100	100		0.00		

Local OD Matrix - Local Matrix: 1

Local Matrix Options

OD Matrix	Name	Use for point to point table	Auto calculate	Allocation mode	Allow paths past exit locations	Allow looped paths on arms	Allow looped paths on traffic nodes	Copy flows	Matrix to copy flows from	Limit paths by length	Path length limit multiplier	Limit paths by number	Path number limit
1	(untitled)	✓	✓	Path Equalisation	✓		✓			✓	1.25		

Normal Input Flows (Veh/hr)

	To							
	1	2	3	4	5	6	7	8
From 1	0	26	174	281	0	0	0	0
From 2	34	0	103	376	0	0	0	0
From 3	197	70	0	71	0	0	0	0
From 4	5	159	35	0	0	0	0	0
From 5	0	0	0	0	0	0	0	0
From 6	0	0	0	0	0	0	0	0
From 7	0	0	0	0	0	0	0	0
From 8	0	0	0	0	0	0	0	0

Bus Input Flows not shown as they are blank.

Tram Input Flows not shown as they are blank.

Pedestrian Input Flows (Veh/hr)

	To							
	1	2	3	4	5	6	7	8
From 1	0	0	0	0	0	0	0	0
From 2	0	0	0	0	0	0	0	0
From 3	0	0	0	0	0	0	0	0
From 4	0	0	0	0	0	0	0	0
From 5	0	0	0	0	0	50	50	0
From 6	0	0	0	0	50	0	0	50
From 7	0	0	0	0	50	0	0	50
From 8	0	0	0	0	0	50	50	0

Locations

OD Matrix	Location	Name	Entries	Exits	Colour
1	1	(untitled)	11/1	Cx/1	#0000FF
	2	(untitled)	12/1	Dx/1	#FF0000
	3	(untitled)	9/1	Ax/1	#00FF00
	4	(untitled)	10/1	Bx/1	#FFFF00
	5	(untitled)	3:2E, 1:1E	3:2X, 1:1X	#FF00FF
	6	(untitled)	2:1E, 1:2E	2:1X, 1:2X	#008000
	7	(untitled)	4:2E, 3:1E	4:2X, 3:1X	#FFA500
	8	(untitled)	4:1E, 2:2E	4:1X, 2:2X	#00FFFF

Normal Paths and Flows

OD Matrix	Path	Description	From location	To location	Path items	Allocation type	Normal Calculated Flow (Veh/hr)
1	9		4	3	10/1, B/2, Ax/1	Normal	35
	10		3	4	9/1, A/1, Bx/1	Normal	71
	11		1	3	11/1, C/1, Ax/1	Normal	174
	12		1	4	11/1, C/2, Bx/1	Normal	281
	13		3	1	9/1, A/1, Cx/1	Normal	197
	14		4	1	10/1, B/1, Cx/1	Normal	5
	15		2	3	12/1, D/1, Ax/1	Normal	103
	16		2	4	12/1, D/1, Bx/1	Normal	376
	19		3	2	9/1, A/2, Dx/1	Normal	70
	20		4	2	10/1, B/1, Dx/1	Normal	159
	43		2	1	12/1, D/2, Cx/1	Normal	34
	44		1	2	11/1, C/1, Dx/1	Normal	26

Pedestrian Paths and Flows

OD Matrix	Path	Description	From location	To location	Path items	Allocation type	Pedestrian calculated flow (Ped/hr)
1	17		8	7	4:1E, 4:2X	Normal	50
	18		8	6	2:2E, 2:1X	Normal	50
	22		5	7	3:2E, 3:1X	Normal	50
	23		5	6	1:1E, 1:2X	Normal	50
	34		6	8	2:1E, 2:2X	Normal	50
	35		6	5	1:2E, 1:1X	Normal	50
	41		7	8	4:2E, 4:1X	Normal	50
	42		7	5	3:1E, 3:2X	Normal	50

Signal Timings

Network Default: 120s cycle time; 120 steps

Controller Stream 1

Controller Stream	Name	Description	Use sequence	Cycle time source	Cycle time (s)
1	(untitled)		1	NetworkDefault	120

Controller Stream 1 - Properties

Controller Stream	Manufacturer name	Type	Model number	(Telephone) Line Number	Site number	Grid reference	Gaining delay type
1	Unspecified						Relative

Controller Stream 1 - Optimisation

Controller Stream	Allow offset optimisation	Allow green split optimisation	Optimisation level	Auto redistribute	Enable stage constraint
1	✓	✓	Offsets And Green Splits	✓	

Phases

Controller Stream	Phase	Name	Minimum green (s)	Maximum green (s)	Relative start displacement (s)	Relative end displacement (s)	Type	Blackout Time (s)
1	A	(untitled)	5	70	0	0	Traffic	
	B	(untitled)	7	70	0	0	Traffic	
	C	(untitled)	7	70	0	0	Traffic	
	D	(untitled)	7	70	0	0	Traffic	
	E	(untitled)	5	5	0	0	Pedestrian	0

Library Stages

Controller Stream	Library Stage	Phases in stage	User stage minimum (s)
1	1	A	1
	2	B	1
	3	C	1
	4	D	1
	5	E	1

Stage Sequences

Controller Stream	Sequence	Name	Multiple cycling	Stage IDs	Stage ends
1	1	(untitled)	Single	1, 2, 3, 4, 5	114, 39, 67, 94, 104

Intergreen Matrix for Controller Stream 1

		To				
		A	B	C	D	E
From	A		5	5	5	5
	B	5		5	5	5
	C	5	5		5	5
	D	5	5	5		5
	E	5	5	5	5	

Banned Stage transitions for Controller Stream 1

		To				
		1	2	3	4	5
From	1					
	2					
	3					
	4					
	5					

Interstage Matrix for Controller Stream 1

		To				
		1	2	3	4	5
From	1	0	5	5	5	5
	2	5	0	5	5	5
	3	5	5	0	5	5
	4	5	5	5	0	5
	5	5	5	5	5	0

Resultant Stages

Controller Stream	Resultant Stage	Is base stage	Library Stage ID	Phases in this stage	Stage start (s)	Stage end (s)	Stage duration (s)	User stage minimum (s)	Stage minimum (s)
1	1	✓	1	A	109	114	5	1	5
	2	✓	2	B	119	39	40	1	7
	3	✓	3	C	44	67	23	1	7
	4	✓	4	D	72	94	22	1	7
	5	✓	5	E	99	104	5	1	5

Resultant Phase Green Periods

Controller Stream	Phase	Green period	Is base green period	Start time (s)	End time (s)	Duration (s)
1	A	1	✓	109	114	5
	B	1	✓	119	39	40
	C	1	✓	44	67	23
	D	1	✓	72	94	22
	E	1	✓	99	104	5

Traffic Stream Green Times

Arm	Traffic Stream	Traffic Node	Controller Stream	Phase	Green Period 1		
					Start	End	Duration
A	1	1	1	D	72	94	22
A	2	1	1	C	44	67	23
B	1	1	1	B	119	39	40
B	2	1	1	A	109	114	5
C	1	1	1	D	72	94	22
C	2	1	1	C	44	67	23
D	1	1	1	B	119	39	40
D	2	1	1	A	109	114	5

Phase Timings Diagram for Controller Stream 1

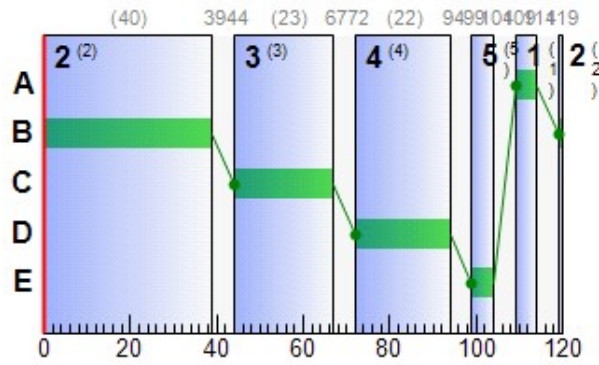

Stage Sequence Diagram for Controller Stream 1

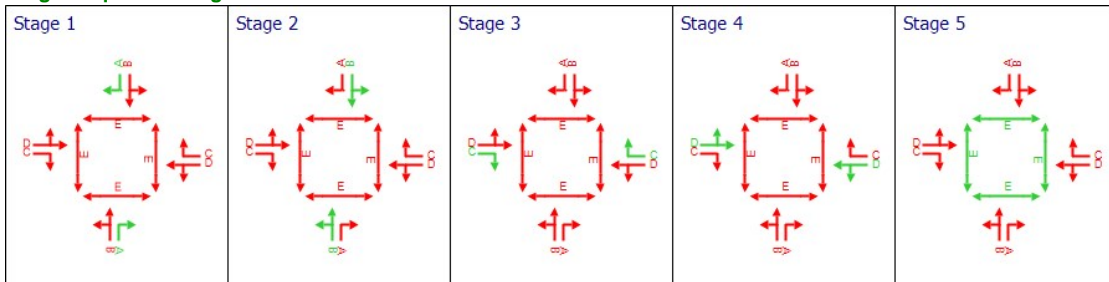

Resultant penalties

Time Segment	Controller stream	Phase min max penalty (£ per hr)	Intergreen broken penalty (£ per hr)	Stage constraint broken penalty (£ per hr)	Cost of controller stream penalties (£ per hr)
08:00-09:00	1	0.00	0.00	0.00	0.00

Traffic Stream Results

Traffic Stream Results: Vehicle summary

Time Segment	Arm	Traffic Stream	Degree of saturation (%)	Practical reserve capacity (%)	Calculated flow entering (Veh/hr)	Calculated sat flow (Veh/hr)	Actual green (s per cycle)	Mean Delay per Veh (s)	Mean max queue (Veh)	Utilised storage (%)	Weighted cost of delay (£ per hr)	Weighted cost of stops (£ per hr)	Performance Index (£ per hr)	
08:00-09:00	A	1	78	29	268	1800	22	63.30	9.70	278.75	66.92	3.60	70.51	
		2	19	414	70	1800	23	41.17	1.95	5.60	11.37	0.72	12.09	
	Ax	1	0	Unrestricted	312	Unrestricted	120	0.00	0.00	0.00	0.00	0.00	0.00	0.00
		2	0	Unrestricted	312	Unrestricted	120	0.00	0.00	0.00	0.00	0.00	0.00	0.00
	B	1	27	275	164	1800	40	29.68	3.97	11.40	19.20	1.47	20.67	
		2	39	157	35	1800	5	67.76	1.25	39.91	9.35	0.46	9.82	
	Bx	1	0	Unrestricted	728	Unrestricted	120	0.00	0.00	0.00	0.00	0.00	0.00	0.00
		2	0	Unrestricted	728	Unrestricted	120	0.00	0.00	0.00	0.00	0.00	0.00	0.00
	C	1	58	73	200	1800	22	51.21	6.45	18.54	40.40	2.39	42.79	
		2	78	28	281	1800	23	62.40	10.14	145.74	69.16	3.76	72.92	
	Cx	1	0	Unrestricted	236	Unrestricted	120	0.00	0.00	0.00	0.00	0.00	0.00	0.00
		2	0	Unrestricted	236	Unrestricted	120	0.00	0.00	0.00	0.00	0.00	0.00	0.00
	D	1	78	28	479	1800	40	45.43	15.57	44.76	85.84	5.76	91.61	
		2	38	165	34	1800	5	67.16	1.21	23.16	9.01	0.45	9.46	
Dx	1	0	Unrestricted	255	Unrestricted	120	0.00	0.00	0.00	0.00	0.00	0.00	0.00	
	2	0	Unrestricted	255	Unrestricted	120	0.00	0.00	0.00	0.00	0.00	0.00	0.00	
9	1	0	Unrestricted	338	Unrestricted	120	0.00	0.00	0.00	0.00	0.00	0.00	0.00	
10	1	0	Unrestricted	199	Unrestricted	120	0.00	0.00	0.00	0.00	0.00	0.00	0.00	
11	1	0	Unrestricted	481	Unrestricted	120	0.00	0.00	0.00	0.00	0.00	0.00	0.00	
12	1	0	Unrestricted	513	Unrestricted	120	0.00	0.00	0.00	0.00	0.00	0.00	0.00	

Traffic Stream Results: Flows and signals

Time Segment	Arm	Traffic Stream	Calculated flow entering (Veh/hr)	Calculated flow out (Veh/hr)	Flow discrepancy (Veh/hr)	Adjusted flow warning	Calculated sat flow (Veh/hr)	Calculated capacity (Veh/hr)	Degree of saturation (%)	DOS Threshold exceeded	Practical reserve capacity (%)	Mean modulus of error	Actual green (s per cycle)
08:00-09:00	A	1	268	268	0		1800	345	78		29	0.00	22
		2	70	70	0		1800	360	19		414	0.00	23
	Ax	1	312	312	0		Unrestricted	Unrestricted	0		Unrestricted	0.71	120
		2	312	312	0		Unrestricted	Unrestricted	0		Unrestricted	0.71	120
	B	1	164	164	0		1800	615	27		275	0.00	40
		2	35	35	0		1800	90	39		157	0.00	5
	Bx	1	728	728	0		Unrestricted	Unrestricted	0		Unrestricted	0.62	120
		2	728	728	0		Unrestricted	Unrestricted	0		Unrestricted	0.62	120
	C	1	200	200	0		1800	345	58		73	0.00	22
		2	281	281	0		1800	360	78		28	0.00	23
	Cx	1	236	236	0		Unrestricted	Unrestricted	0		Unrestricted	1.15	120
		2	236	236	0		Unrestricted	Unrestricted	0		Unrestricted	1.15	120
	D	1	479	479	0		1800	615	78		28	0.00	40
		2	34	34	0		1800	90	38		165	0.00	5
Dx	1	255	255	0		Unrestricted	Unrestricted	0		Unrestricted	0.79	120	
	2	255	255	0		Unrestricted	Unrestricted	0		Unrestricted	0.79	120	
9	1	338	338	0		Unrestricted	Unrestricted	0		Unrestricted	0.00	120	
10	1	199	199	0		Unrestricted	Unrestricted	0		Unrestricted	0.00	120	
11	1	481	481	0		Unrestricted	Unrestricted	0		Unrestricted	0.00	120	
12	1	513	513	0		Unrestricted	Unrestricted	0		Unrestricted	0.00	120	

Traffic Stream Results: Stops and delays

Time Segment	Arm	Traffic Stream	Mean Cruise Time per Veh (s)	Mean Delay per Veh (s)	Uniform delay (Veh-hr/hr)	Random plus oversat delay (Veh-hr/hr)	Weighted cost of delay (£ per hr)	Mean stops per Veh (%)	Uniform stops (Stops per hr)	Random stops (Stops per hr)	Weighted cost of stops (£ per hr)	
08:00-09:00	A	1	2.40	63.30	3.43	1.28	66.92	107.00	249.60	37.15	3.60	
		2	24.00	41.17	0.78	0.02	11.37	82.52	57.06	0.70	0.72	
	Ax	1	21.95	0.00	0.00	0.00	0.00	0.00	0.00	0.00	0.00	0.00
		1	24.00	29.68	1.30	0.05	19.20	71.56	115.92	1.45	1.47	
	B	2	2.16	67.76	0.54	0.12	9.35	105.83	33.49	3.55	0.46	
		1	21.41	0.00	0.00	0.00	0.00	0.00	0.00	0.00	0.00	0.00
	Cx	1	24.00	51.21	2.45	0.39	40.40	95.30	178.94	11.66	2.39	
		2	4.80	62.40	3.55	1.32	69.16	106.68	261.57	38.19	3.76	
	D	1	23.38	0.00	0.00	0.00	0.00	0.00	0.00	0.00	0.00	0.00
		1	24.00	45.43	4.71	1.33	85.84	95.98	420.66	39.09	5.76	
	Dx	2	3.60	67.16	0.52	0.11	9.01	105.38	32.53	3.30	0.45	
		1	21.24	0.00	0.00	0.00	0.00	0.00	0.00	0.00	0.00	0.00
	9	1	5.82	0.00	0.00	0.00	0.00	0.00	0.00	0.00	0.00	0.00
	10	1	3.78	0.00	0.00	0.00	0.00	0.00	0.00	0.00	0.00	0.00
11	1	4.44	0.00	0.00	0.00	0.00	0.00	0.00	0.00	0.00	0.00	
12	1	4.12	0.00	0.00	0.00	0.00	0.00	0.00	0.00	0.00	0.00	

Traffic Stream Results: Queues and blocking

Time Segment	Arm	Traffic Stream	Initial queue (Veh)	Mean max queue (Veh)	Max queue storage (Veh)	Utilised storage (%)	Average storage excess queue (Veh)	Average limit excess queue (Veh)	Excess queue penalty (£ per hr)	Wasted time starvation (s per cycle)	Wasted time blocking back (s per cycle)	Wasted time total (s per cycle)	Estimated blocking	
08:00-09:00	A	1	0.00	9.70	3.48	278.75	2.19	0.00	0.00	0.00	0.00	0.00		
		2	0.00	1.95	34.78	5.60	0.00	0.00	0.00	0.00	0.00	0.00	0.00	
	Ax	1	0.00	0.00	31.81	0.00	0.00	0.00	0.00	0.00	29.00	0.00	29.00	
		1	0.00	3.97	34.78	11.40	0.00	0.00	0.00	0.00	0.00	0.00	0.00	
	B	2	0.00	1.25	3.13	39.91	0.00	0.00	0.00	0.00	3.00	0.00	3.00	
		1	0.00	0.00	31.03	0.00	0.00	0.00	0.00	0.00	16.00	0.00	16.00	
	Cx	1	0.00	6.45	34.78	18.54	0.00	0.00	0.00	0.00	0.00	0.00	0.00	
		2	0.00	10.14	6.96	145.74	0.55	0.00	0.00	0.00	0.00	0.00	0.00	
	D	1	0.00	0.00	33.88	0.00	0.00	0.00	0.00	0.00	62.00	0.00	62.00	
		1	0.00	15.57	34.78	44.76	0.00	0.00	0.00	0.00	0.00	0.00	0.00	
	Dx	2	0.00	1.21	5.22	23.16	0.00	0.00	0.00	0.00	3.00	0.00	3.00	
		1	0.00	0.00	30.79	0.00	0.00	0.00	0.00	0.00	26.00	0.00	26.00	
	9	1	0.00	0.00	8.44	0.00	0.00	0.00	0.00	0.00	84.00	0.00	84.00	
	10	1	0.00	0.00	5.47	0.00	0.00	0.00	0.00	0.00	0.00	0.00	0.00	
11	1	0.00	0.00	6.44	0.00	0.00	0.00	0.00	0.00	41.00	0.00	41.00		
12	1	0.00	0.00	5.97	0.00	0.00	0.00	0.00	0.00	0.00	0.00	0.00		

Pedestrian Crossing Results

Pedestrian Crossings: Pedestrian summary

Time Segment	Crossing	Side	Degree of saturation (%)	Calculated Flow Entering (Ped/hr)	Calculated sat flow (Ped/hr)	Actual green (s per cycle)	Mean Delay Per Ped (s)	Mean max queue (Ped)	Weighted cost of delay (£ per hr)	Performance Index (£ per hr)
08:00-09:00	(ALL)	(ALL)	11	50	11000	5	55.58	1.60	10.96	10.96

Pedestrian Crossings: Flows and signals

Time Segment	Crossing	Side	Calculated flow entering (Ped/hr)	Calculated flow out (Ped/hr)	Flow discrepancy (Ped/hr)	Adjusted flow warning	Calculated sat flow (Ped/hr)	Calculated capacity (Ped/hr)	Degree of saturation (%)	DOS Threshold exceeded	Practical reserve capacity (%)	Mean modulus of error	Actual green (s per cycle)
08:00-09:00	(ALL)	(ALL)	50	50	0		11000	458	11		817	0.00	5

Pedestrian Crossings: Stops and delays

Time Segment	Crossing	Side	Mean Cruise Time per Ped (s)	Mean Delay per Ped (s)	Uniform delay (Ped-hr/hr)	Random plus oversat delay (Ped-hr/hr)	Weighted cost of delay (£ per hr)
08:00-09:00	1	1	5.67	55.58	0.77	0.00	10.96
		2	5.67	55.58	0.77	0.00	10.96
	2	1	6.33	55.58	0.77	0.00	10.96
		2	6.33	55.58	0.77	0.00	10.96
	3	1	6.33	55.58	0.77	0.00	10.96
		2	6.33	55.58	0.77	0.00	10.96
	4	1	5.67	55.58	0.77	0.00	10.96
		2	5.67	55.58	0.77	0.00	10.96

Pedestrian Crossings: Queues and blocking

Time Segment	Crossing	Side	Mean max queue (Ped)	Max queue storage (Ped)	Utilised storage (%)	Average storage excess queue (Ped)	Average limit excess queue (Ped)	Excess queue penalty (£ per hr)
08:00-09:00	(ALL)	(ALL)	1.60	10.00	15.97	0.00	0.00	0.00

Network Results

Network Results: Flows and signals

Time Segment	Calculated flow entering (Veh/hr)	Calculated flow out (Veh/hr)	Flow discrepancy (Veh/hr)	Adjusted flow warning	Degree of saturation (%)	DOS Threshold exceeded	Practical reserve capacity (%)	Actual green (s (per cycle))
08:00-09:00	4993	4993	0		78		28	1180

Network Results: Stops and delays

Time Segment	Mean Cruise Time per Veh (s)	Mean Delay per Veh (s)	Uniform delay (Veh-hr/hr)	Random plus oversat delay (Veh-hr/hr)	Weighted cost of delay (£ per hr)	Mean stops per Veh (%)	Uniform stops (Stops per hr)	Random stops (Stops per hr)	Weighted cost of stops (£ per hr)
08:00-09:00	13.39	20.26	23.46	4.63	398.94	29.74	1349.77	135.09	18.62

Network Results: Queues and blocking

Time Segment	Utilised storage (%)	Excess queue penalty (£ per hr)	Wasted time starvation (s (per cycle))	Wasted time blocking back (s (per cycle))	Wasted time total (s (per cycle))
08:00-09:00	278.75	0.00	139.00	125.00	264.00

Final Prediction Table

Traffic Stream Results

Arm	Traffic Stream	Name	Traffic node	SIGNALS		FLOWS		PERFORMANCE				PER PCU			QUEUES
				Controller stream	Phase	Calculated flow entering (Veh/hr)	Calculated sat flow (Veh/hr)	Actual green (s per cycle)	Wasted time total (s per cycle)	Degree of saturation (%)	Practical reserve capacity (%)	JourneyTime (s)	Mean Delay per Veh (s)	Mean stops per Veh (%)	Mean max queue (Veh)
A	1	(untitled)	1	1	D	268 <	1800	22	0.00	78	29	65.70	63.30	107.00	9.70 +
	2		1	1	C	70	1800	23	0.00	19	414	65.17	41.17	82.52	1.95
Ax	1	(untitled)				312	Unrestricted	120	29.00	0	Unrestricted	21.95	0.00	0.00	0.00
B	1	(untitled)	1	1	B	164	1800	40	0.00	27	275	53.68	29.68	71.56	3.97
	2		1	1	A	35	1800	5	3.00	39	157	69.92	67.76	105.83	1.25
Bx	1	(untitled)				728	Unrestricted	120	16.00	0	Unrestricted	21.41	0.00	0.00	0.00
C	1	(untitled)	1	1	D	200	1800	22	0.00	58	73	75.21	51.21	95.30	6.45
	2		1	1	C	281 <	1800	23	0.00	78	28	67.20	62.40	106.68	10.14 +
Cx	1	(untitled)				236	Unrestricted	120	62.00	0	Unrestricted	23.38	0.00	0.00	0.00
D	1	(untitled)	1	1	B	479	1800	40	0.00	78	28	69.43	45.43	95.98	15.57
	2		1	1	A	34	1800	5	3.00	38	165	70.76	67.16	105.38	1.21
Dx	1	(untitled)				255	Unrestricted	120	26.00	0	Unrestricted	21.24	0.00	0.00	0.00
9	1		1			338	Unrestricted	120	84.00	0	Unrestricted	5.82	0.00	0.00	0.00
10	1		1			199	Unrestricted	120	0.00	0	Unrestricted	3.78	0.00	0.00	0.00
11	1		1			481	Unrestricted	120	41.00	0	Unrestricted	4.44	0.00	0.00	0.00
12	1		1			513	Unrestricted	120	0.00	0	Unrestricted	4.12	0.00	0.00	0.00

Pedestrian Crossing Results

Pedestrian	Side	Name	Traffic node	SIGNALS		FLOWS		PERFORMANCE			PER PED		QUEUES	WEIGHTS	PEN
				Controller stream	Phase	Calculated Flow Entering (Ped/hr)	Calculated sat flow (Ped/hr)	Actual green (s per cycle)	Degree of saturation (%)	Practical reserve capacity (%)	JourneyTime (s)	Mean Delay per Ped (s)	Mean max queue (Ped)	Delay weighting (%)	Co tra pen (£ p
1	1	(untitled)	1	1	E	50	11000	5	11	817	61.25	55.58	1.60	100	0
	2	(untitled)	1	1	E	50	11000	5	11	817	61.25	55.58	1.60	100	0
2	1	(untitled)	1	1	E	50	11000	5	11	817	61.92	55.58	1.60	100	0
	2	(untitled)	1	1	E	50	11000	5	11	817	61.92	55.58	1.60	100	0
3	1	(untitled)	1	1	E	50	11000	5	11	817	61.92	55.58	1.60	100	0
	2	(untitled)	1	1	E	50	11000	5	11	817	61.92	55.58	1.60	100	0
4	1	(untitled)	1	1	E	50	11000	5	11	817	61.25	55.58	1.60	100	0
	2	(untitled)	1	1	E	50	11000	5	11	817	61.25	55.58	1.60	100	0

Network Results

	Distance travelled (PCU-km/hr)	Time spent (PCU-hr/hr)	Mean journey speed (kph)	Uniform delay (Veh-hr/hr)	Random plus oversat delay (Veh-hr/hr)	Weighted cost of delay (£ per hr)	Weighted cost of stops (£ per hr)	Excess queue penalty (£ per hr)	Performance Index (£ per hr)
Normal traffic	537.04	39.82	13.49	17.29	4.63	311.25	18.62	0.00	329.86
Bus	0.00	0.00	0.00	0.00	0.00	0.00	0.00	0.00	0.00
Tram	0.00	0.00	0.00	0.00	0.00	0.00	0.00	0.00	0.00
Pedestrians	3.40	6.84	0.50	6.18	0.00	87.70	0.00	0.00	87.70
TOTAL	540.44	46.66	11.58	23.46	4.63	398.94	18.62	0.00	417.56

- 1 < = adjusted flow warning (upstream links/traffic streams are over-saturated)
- 1 * = Traffic Stream - Normal, Bus or Tram Stop or Delay weighting has been set to a value other than 100%
- 1 ^ = Traffic Stream - Normal, Bus or Tram Stop or Delay Path weighting has been set to a value other than 100%
- 1 + = average link/traffic stream excess queue is greater than 0
- 1 **P.I. = PERFORMANCE INDEX**

A6 - DO SOMETHING 2029 D6 - DO SOMETHING 2029*

Summary

Data Errors and Warnings

No errors or warnings

Run Summary

Analysis set used	Run start time	Run finish time	Modelling start time (HH:mm)	Network Cycle Time (s)	Performance Index (£ per hr)	Total network delay (Veh-hr/hr)	Highest DOS (%)	Item with highest DOS	Number of oversaturated items	Percentage of oversaturated items (%)	Item with worst signalised PRC	Item with worst unsignalised PRC	Item with worst over PR
6	19/08/2020 12:04:20	19/08/2020 12:04:21	08:00	120	506.72	34.12	87.00	D/1	0	0	D/1	Dx/1	D/

Analysis Set Details

Name	Description	Demand set	Include in report	Locked
DO SOMETHING 2029		D6	✓	

Demand Set Details

Name	Description	Composite	Demand sets	Start time (HH:mm)	Locked
DO SOMETHING 2029				08:00	

Arms and Traffic Streams

Arms

Arm	Name	Description	Traffic node
A	(untitled)		1
Ax	(untitled)		
B	(untitled)		1
Bx	(untitled)		
C	(untitled)		1
Cx	(untitled)		
D	(untitled)		1
Dx	(untitled)		
9			1
10			1
11			1
12			1

Traffic Streams

Arm	Traffic Stream	Name	Description	Auto length	Length (m)	Has Saturation Flow	Saturation flow source	Saturation flow (PCU/hr)	Is signal controlled	Is give way	Traffic type	Allow Nearside Turn On Red
A	1	(untitled)			20.00	✓	Sum of lanes	1800	✓		Normal	
	2				200.00	✓	Sum of lanes	1800	✓		Normal	
Ax	1	(untitled)		✓	182.93						Normal	
B	1	(untitled)			200.00	✓	Sum of lanes	1800	✓		Normal	
	2				18.00	✓	Sum of lanes	1800	✓		Normal	
Bx	1	(untitled)		✓	178.44						Normal	
C	1	(untitled)			200.00	✓	Sum of lanes	1800	✓		Normal	
	2				40.00	✓	Sum of lanes	1800	✓		Normal	
Cx	1	(untitled)		✓	194.82						Normal	
D	1	(untitled)			200.00	✓	Sum of lanes	1800	✓		Normal	
	2				30.00	✓	Sum of lanes	1800	✓		Normal	
Dx	1	(untitled)		✓	177.04						Normal	
9	1			✓	48.53						Normal	
10	1			✓	31.46						Normal	
11	1			✓	37.01						Normal	
12	1			✓	34.36						Normal	

Lanes

Arm	Traffic Stream	Lane	Name	Description	Use RR67	Saturation flow (PCU/hr)
A	1	1	(untitled)			1800
	2	1	(untitled)			1800
Ax	1	1	(untitled)			
B	1	1	(untitled)			1800
	2	1	(untitled)			1800
Bx	1	1	(untitled)			
C	1	1	(untitled)			1800
	2	1	(untitled)			1800
Cx	1	1	(untitled)			
D	1	1	(untitled)			1800
	2	1	(untitled)			1800
Dx	1	1	(untitled)			
9	1	1	(untitled)			
10	1	1	(untitled)			
11	1	1	(untitled)			
12	1	1	(untitled)			

Modelling

Arm	Traffic Stream	Traffic model	Stop weighting multiplier (%)	Delay weighting multiplier (%)	Assignment Cost Weighting (%)	Exclude from results calculation	Max queue storage (PCU)	Has queue limit	Has degree of saturation limit
(ALL)	(ALL)	NetworkDefault	100	100	100		0.00		

Modelling - Advanced

Arm	Traffic Stream	Initial queue (PCU)	Type of Vehicle-in-Service	Vehicle-in-Service	Type of random parameter	Random parameter	Auto cycle time	Cycle time
(ALL)	(ALL)	0.00	NetworkDefault	Not-Included	NetworkDefault	0.50	✓	120

Normal traffic - Modelling

Arm	Traffic Stream	Stop weighting (%)	Delay weighting (%)
(ALL)	(ALL)	100	100

Normal traffic - Advanced

Arm	Traffic Stream	Dispersion type for Normal Traffic
(ALL)	(ALL)	NetworkDefault

Flows

Arm	Traffic Stream	Total Flow (Veh/hr)	Normal Flow (Veh/hr)
A	1	308	308
	2	76	76
Ax	1	344	344
B	1	179	179
	2	39	39
Bx	1	798	798
C	1	223	223
	2	311	311
Cx	1	277	277
D	1	522	522
	2	40	40
Dx	1	279	279
9	1	384	384
10	1	218	218
11	1	534	534
12	1	562	562

Signals

Arm	Traffic Stream	Controller stream	Phase	Second phase enabled
A	1	1	D	
	2	1	C	
B	1	1	B	
	2	1	A	
C	1	1	D	
	2	1	C	
D	1	1	B	
	2	1	A	

Pedestrian Crossings

Pedestrian Crossings

Crossing	Name	Description	Traffic node	Allow walk on red	Crossing type	Length (m)	Cruise time (seconds)	Cruise speed (kph)
1	(untitled)		1		Farside	7.00	4.67	5.40
2	(untitled)		1		Farside	8.00	5.33	5.40
3	(untitled)		1		Farside	8.00	5.33	5.40
4	(untitled)		1		Farside	7.00	4.67	5.40

Pedestrian Crossings - Signals

Crossing	Controller stream	Phase	Second phase enabled
(ALL)	1	E	

Pedestrian Crossings - Sides

Crossing	Side	Saturation flow (Ped/hr)
(ALL)	(ALL)	11000

Pedestrian Crossings - Modelling

Crossing	Side	Delay weighting (%)	Assignment Cost Weighting (%)	Exclude from results calculation	Max queue storage (Ped)	Has queue limit	Has degree of saturation limit
(ALL)	(ALL)	100	100		0.00		

Local OD Matrix - Local Matrix: 1

Local Matrix Options

OD Matrix	Name	Use for point to point table	Auto calculate	Allocation mode	Allow paths past exit locations	Allow looped paths on arms	Allow looped paths on traffic nodes	Copy flows	Matrix to copy flows from	Limit paths by length	Path length limit multiplier	Limit paths by number	Path number limit
1	(untitled)	✓	✓	Path Equalisation	✓		✓			✓	1.25		

Normal Input Flows (Veh/hr)

	To							
	1	2	3	4	5	6	7	8
From 1	0	30	193	311	0	0	0	0
From 2	40	0	112	410	0	0	0	0
From 3	231	76	0	77	0	0	0	0
From 4	6	173	39	0	0	0	0	0
From 5	0	0	0	0	0	0	0	0
From 6	0	0	0	0	0	0	0	0
From 7	0	0	0	0	0	0	0	0
From 8	0	0	0	0	0	0	0	0

Bus Input Flows not shown as they are blank.

Tram Input Flows not shown as they are blank.

Pedestrian Input Flows (Veh/hr)

	To							
	1	2	3	4	5	6	7	8
From 1	0	0	0	0	0	0	0	0
From 2	0	0	0	0	0	0	0	0
From 3	0	0	0	0	0	0	0	0
From 4	0	0	0	0	0	0	0	0
From 5	0	0	0	0	0	50	50	0
From 6	0	0	0	0	50	0	0	50
From 7	0	0	0	0	50	0	0	50
From 8	0	0	0	0	0	50	50	0

Locations

OD Matrix	Location	Name	Entries	Exits	Colour
1	1	(untitled)	11/1	Cx/1	#0000FF
	2	(untitled)	12/1	Dx/1	#FF0000
	3	(untitled)	9/1	Ax/1	#00FF00
	4	(untitled)	10/1	Bx/1	#FFFF00
	5	(untitled)	3:2E, 1:1E	3:2X, 1:1X	#FF00FF
	6	(untitled)	2:1E, 1:2E	2:1X, 1:2X	#008000
	7	(untitled)	4:2E, 3:1E	4:2X, 3:1X	#FFA500
	8	(untitled)	4:1E, 2:2E	4:1X, 2:2X	#00FFFF

Normal Paths and Flows

OD Matrix	Path	Description	From location	To location	Path items	Allocation type	Normal Calculated Flow (Veh/hr)
1	9		4	3	10/1, B/2, Ax/1	Normal	39
	10		3	4	9/1, A/1, Bx/1	Normal	77
	11		1	3	11/1, C/1, Ax/1	Normal	193
	12		1	4	11/1, C/2, Bx/1	Normal	311
	13		3	1	9/1, A/1, Cx/1	Normal	231
	14		4	1	10/1, B/1, Cx/1	Normal	6
	15		2	3	12/1, D/1, Ax/1	Normal	112
	16		2	4	12/1, D/1, Bx/1	Normal	410
	19		3	2	9/1, A/2, Dx/1	Normal	76
	20		4	2	10/1, B/1, Dx/1	Normal	173
	43		2	1	12/1, D/2, Cx/1	Normal	40
	44		1	2	11/1, C/1, Dx/1	Normal	30

Pedestrian Paths and Flows

OD Matrix	Path	Description	From location	To location	Path items	Allocation type	Pedestrian calculated flow (Ped/hr)
1	17		8	7	4:1E, 4:2X	Normal	50
	18		8	6	2:2E, 2:1X	Normal	50
	22		5	7	3:2E, 3:1X	Normal	50
	23		5	6	1:1E, 1:2X	Normal	50
	34		6	8	2:1E, 2:2X	Normal	50
	35		6	5	1:2E, 1:1X	Normal	50
	41		7	8	4:2E, 4:1X	Normal	50
	42		7	5	3:1E, 3:2X	Normal	50

Signal Timings

Network Default: 120s cycle time; 120 steps

Controller Stream 1

Controller Stream	Name	Description	Use sequence	Cycle time source	Cycle time (s)
1	(untitled)		1	NetworkDefault	120

Controller Stream 1 - Properties

Controller Stream	Manufacturer name	Type	Model number	(Telephone) Line Number	Site number	Grid reference	Gaining delay type
1	Unspecified						Relative

Controller Stream 1 - Optimisation

Controller Stream	Allow offset optimisation	Allow green split optimisation	Optimisation level	Auto redistribute	Enable stage constraint
1	✓	✓	Offsets And Green Splits	✓	

Phases

Controller Stream	Phase	Name	Minimum green (s)	Maximum green (s)	Relative start displacement (s)	Relative end displacement (s)	Type	Blackout Time (s)
1	A	(untitled)	5	70	0	0	Traffic	
	B	(untitled)	7	70	0	0	Traffic	
	C	(untitled)	7	70	0	0	Traffic	
	D	(untitled)	7	70	0	0	Traffic	
	E	(untitled)	5	5	0	0	Pedestrian	0

Library Stages

Controller Stream	Library Stage	Phases in stage	User stage minimum (s)
1	1	A	1
	2	B	1
	3	C	1
	4	D	1
	5	E	1

Stage Sequences

Controller Stream	Sequence	Name	Multiple cycling	Stage IDs	Stage ends
1	1	(untitled)	Single	1, 2, 3, 4, 5	114, 38, 66, 94, 104

Intergreen Matrix for Controller Stream 1

		To				
		A	B	C	D	E
From	A		5	5	5	5
	B	5		5	5	5
	C	5	5		5	5
	D	5	5	5		5
	E	5	5	5	5	

Banned Stage transitions for Controller Stream 1

		To				
		1	2	3	4	5
From	1					
	2					
	3					
	4					
	5					

Interstage Matrix for Controller Stream 1

		To				
		1	2	3	4	5
From	1	0	5	5	5	5
	2	5	0	5	5	5
	3	5	5	0	5	5
	4	5	5	5	0	5
	5	5	5	5	5	0

Resultant Stages

Controller Stream	Resultant Stage	Is base stage	Library Stage ID	Phases in this stage	Stage start (s)	Stage end (s)	Stage duration (s)	User stage minimum (s)	Stage minimum (s)
1	1	✓	1	A	109	114	5	1	5
	2	✓	2	B	119	38	39	1	7
	3	✓	3	C	43	66	23	1	7
	4	✓	4	D	71	94	23	1	7
	5	✓	5	E	99	104	5	1	5

Resultant Phase Green Periods

Controller Stream	Phase	Green period	Is base green period	Start time (s)	End time (s)	Duration (s)
1	A	1	✓	109	114	5
	B	1	✓	119	38	39
	C	1	✓	43	66	23
	D	1	✓	71	94	23
	E	1	✓	99	104	5

Traffic Stream Green Times

Arm	Traffic Stream	Traffic Node	Controller Stream	Phase	Green Period 1		
					Start	End	Duration
A	1	1	1	D	71	94	23
A	2	1	1	C	43	66	23
B	1	1	1	B	119	38	39
B	2	1	1	A	109	114	5
C	1	1	1	D	71	94	23
C	2	1	1	C	43	66	23
D	1	1	1	B	119	38	39
D	2	1	1	A	109	114	5

Phase Timings Diagram for Controller Stream 1

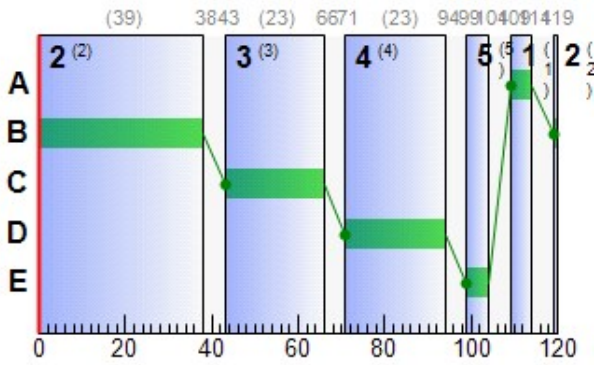

Stage Sequence Diagram for Controller Stream 1

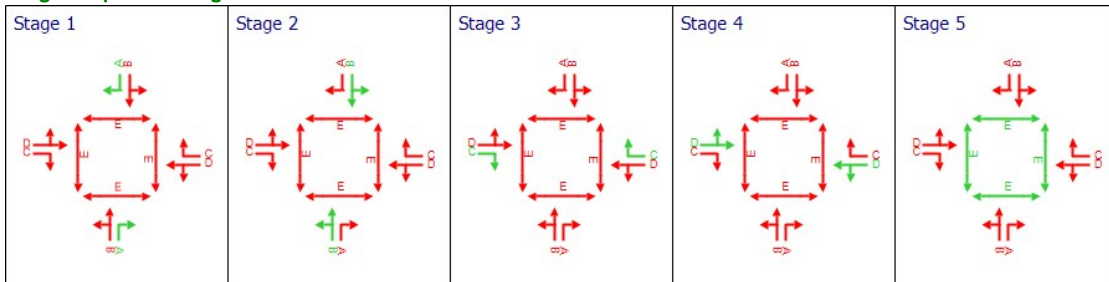

Resultant penalties

Time Segment	Controller stream	Phase min max penalty (£ per hr)	Intergreen broken penalty (£ per hr)	Stage constraint broken penalty (£ per hr)	Cost of controller stream penalties (£ per hr)
08:00-09:00	1	0.00	0.00	0.00	0.00

Traffic Stream Results

Traffic Stream Results: Vehicle summary

Time Segment	Arm	Traffic Stream	Degree of saturation (%)	Practical reserve capacity (%)	Calculated flow entering (Veh/hr)	Calculated sat flow (Veh/hr)	Actual green (s per cycle)	Mean Delay per Veh (s)	Mean max queue (Veh)	Utilised storage (%)	Weighted cost of delay (£ per hr)	Weighted cost of stops (£ per hr)	Performance Index (£ per hr)	
08:00-09:00	A	1	86	17	308	1800	23	72.78	12.10	347.93	88.42	4.46	92.88	
		2	21	374	76	1800	23	41.45	2.14	6.15	12.42	0.79	13.22	
	Ax	1	0	Unrestricted	344	Unrestricted	120	0.00	0.00	0.00	0.00	0.00	0.00	0.00
		2	0	Unrestricted	344	Unrestricted	120	0.00	0.00	0.00	0.00	0.00	0.00	0.00
	B	1	30	235	179	1800	39	30.89	4.44	12.76	21.81	1.65	23.46	
		2	43	131	39	1800	5	70.34	1.42	45.32	10.82	0.53	11.35	
	Bx	1	0	Unrestricted	798	Unrestricted	120	0.00	0.00	0.00	0.00	0.00	0.00	0.00
		2	0	Unrestricted	798	Unrestricted	120	0.00	0.00	0.00	0.00	0.00	0.00	0.00
	C	1	62	61	223	1800	23	51.85	7.25	20.84	45.60	2.69	48.30	
		2	86	16	311	1800	23	74.41	12.44	178.82	91.29	4.56	95.84	
	Cx	1	0	Unrestricted	277	Unrestricted	120	0.00	0.00	0.00	0.00	0.00	0.00	0.00
		2	0	Unrestricted	277	Unrestricted	120	0.00	0.00	0.00	0.00	0.00	0.00	0.00
	D	1	87	15	522	1800	39	55.97	18.91	54.36	115.24	6.98	122.23	
		2	44	125	40	1800	5	71.04	1.46	28.03	11.21	0.54	11.75	
Dx	1	0	Unrestricted	279	Unrestricted	120	0.00	0.00	0.00	0.00	0.00	0.00	0.00	
	2	0	Unrestricted	279	Unrestricted	120	0.00	0.00	0.00	0.00	0.00	0.00	0.00	
9	1	0	Unrestricted	384	Unrestricted	120	0.00	0.00	0.00	0.00	0.00	0.00	0.00	
10	1	0	Unrestricted	218	Unrestricted	120	0.00	0.00	0.00	0.00	0.00	0.00	0.00	
11	1	0	Unrestricted	534	Unrestricted	120	0.00	0.00	0.00	0.00	0.00	0.00	0.00	
12	1	0	Unrestricted	562	Unrestricted	120	0.00	0.00	0.00	0.00	0.00	0.00	0.00	

Traffic Stream Results: Flows and signals

Time Segment	Arm	Traffic Stream	Calculated flow entering (Veh/hr)	Calculated flow out (Veh/hr)	Flow discrepancy (Veh/hr)	Adjusted flow warning	Calculated sat flow (Veh/hr)	Calculated capacity (Veh/hr)	Degree of saturation (%)	DOS Threshold exceeded	Practical reserve capacity (%)	Mean modulus of error	Actual green (s per cycle)
08:00-09:00	A	1	308	308	0		1800	360	86		17	0.00	23
		2	76	76	0		1800	360	21		374	0.00	23
	Ax	1	344	344	0		Unrestricted	Unrestricted	0		Unrestricted	0.67	120
		2	344	344	0		Unrestricted	Unrestricted	0		Unrestricted	0.67	120
	B	1	179	179	0		1800	600	30		235	0.00	39
		2	39	39	0		1800	90	43		131	0.00	5
	Bx	1	798	798	0		Unrestricted	Unrestricted	0		Unrestricted	0.60	120
		2	798	798	0		Unrestricted	Unrestricted	0		Unrestricted	0.60	120
	C	1	223	223	0		1800	360	62		61	0.00	23
		2	311	311	0		1800	360	86		16	0.00	23
	Cx	1	277	277	0		Unrestricted	Unrestricted	0		Unrestricted	1.12	120
		2	277	277	0		Unrestricted	Unrestricted	0		Unrestricted	1.12	120
	D	1	522	522	0		1800	600	87		15	0.00	39
		2	40	40	0		1800	90	44		125	0.00	5
Dx	1	279	279	0		Unrestricted	Unrestricted	0		Unrestricted	0.79	120	
	2	279	279	0		Unrestricted	Unrestricted	0		Unrestricted	0.79	120	
9	1	384	384	0		Unrestricted	Unrestricted	0		Unrestricted	0.00	120	
10	1	218	218	0		Unrestricted	Unrestricted	0		Unrestricted	0.00	120	
11	1	534	534	0		Unrestricted	Unrestricted	0		Unrestricted	0.00	120	
12	1	562	562	0		Unrestricted	Unrestricted	0		Unrestricted	0.00	120	

Traffic Stream Results: Stops and delays

Time Segment	Arm	Traffic Stream	Mean Cruise Time per Veh (s)	Mean Delay per Veh (s)	Uniform delay (Veh-hr/hr)	Random plus oversat delay (Veh-hr/hr)	Weighted cost of delay (£ per hr)	Mean stops per Veh (%)	Uniform stops (Stops per hr)	Random stops (Stops per hr)	Weighted cost of stops (£ per hr)	
08:00-09:00	A	1	2.40	72.78	3.96	2.26	88.42	115.62	291.81	64.28	4.46	
		2	24.00	41.45	0.85	0.03	12.42	83.41	62.54	0.84	0.79	
	Ax	1	21.95	0.00	0.00	0.00	0.00	0.00	0.00	0.00	0.00	0.00
		2	24.00	30.89	1.47	0.06	21.81	73.40	129.49	1.89	1.65	
	B	1	24.00	30.89	1.47	0.06	21.81	73.40	129.49	1.89	1.65	
		2	2.16	70.34	0.60	0.16	10.82	107.76	37.32	4.71	0.53	
	Bx	1	21.41	0.00	0.00	0.00	0.00	0.00	0.00	0.00	0.00	0.00
		2	24.00	51.85	2.72	0.50	45.60	96.31	200.14	14.64	2.69	
	C	1	24.00	51.85	2.72	0.50	45.60	96.31	200.14	14.64	2.69	
		2	4.80	74.41	4.01	2.42	91.29	116.92	295.14	68.48	4.56	
	Cx	1	23.38	0.00	0.00	0.00	0.00	0.00	0.00	0.00	0.00	0.00
		2	24.00	55.97	5.45	2.67	115.24	106.71	479.94	77.08	6.98	
	D	1	24.00	55.97	5.45	2.67	115.24	106.71	479.94	77.08	6.98	
		2	3.60	71.04	0.62	0.17	11.21	108.28	38.27	5.04	0.54	
Dx	1	21.24	0.00	0.00	0.00	0.00	0.00	0.00	0.00	0.00	0.00	
	2	21.24	0.00	0.00	0.00	0.00	0.00	0.00	0.00	0.00	0.00	
9	1	5.82	0.00	0.00	0.00	0.00	0.00	0.00	0.00	0.00	0.00	
10	1	3.78	0.00	0.00	0.00	0.00	0.00	0.00	0.00	0.00	0.00	
11	1	4.44	0.00	0.00	0.00	0.00	0.00	0.00	0.00	0.00	0.00	
12	1	4.12	0.00	0.00	0.00	0.00	0.00	0.00	0.00	0.00	0.00	

Traffic Stream Results: Queues and blocking

Time Segment	Arm	Traffic Stream	Initial queue (Veh)	Mean max queue (Veh)	Max queue storage (Veh)	Utilised storage (%)	Average storage excess queue (Veh)	Average limit excess queue (Veh)	Excess queue penalty (£ per hr)	Wasted time starvation (s per cycle)	Wasted time blocking back (s per cycle)	Wasted time total (s per cycle)	Estimated blocking	
08:00-09:00	A	1	0.00	12.10	3.48	347.93	3.66	0.00	0.00	0.00	0.00	0.00		
		2	0.00	2.14	34.78	6.15	0.00	0.00	0.00	0.00	0.00	0.00	0.00	
	Ax	1	0.00	0.00	31.81	0.00	0.00	0.00	0.00	0.00	25.00	0.00	25.00	
		2	0.00	4.44	34.78	12.76	0.00	0.00	0.00	0.00	0.00	0.00	0.00	
	B	1	0.00	4.44	34.78	12.76	0.00	0.00	0.00	0.00	0.00	0.00	0.00	
		2	0.00	1.42	3.13	45.32	0.00	0.00	0.00	0.00	3.00	0.00	3.00	
	Bx	1	0.00	0.00	31.03	0.00	0.00	0.00	0.00	0.00	15.00	0.00	15.00	
		2	0.00	7.25	34.78	20.84	0.00	0.00	0.00	0.00	0.00	0.00	0.00	
	C	1	0.00	7.25	34.78	20.84	0.00	0.00	0.00	0.00	0.00	0.00	0.00	
		2	0.00	12.44	6.96	178.82	1.47	0.00	0.00	0.00	0.00	0.00	0.00	
	Cx	1	0.00	0.00	33.88	0.00	0.00	0.00	0.00	0.00	59.00	0.00	59.00	
		2	0.00	18.91	34.78	54.36	0.00	0.00	0.00	0.00	0.00	0.00	0.00	
	D	1	0.00	18.91	34.78	54.36	0.00	0.00	0.00	0.00	0.00	0.00	0.00	
		2	0.00	1.46	5.22	28.03	0.00	0.00	0.00	0.00	3.00	0.00	3.00	
Dx	1	0.00	0.00	30.79	0.00	0.00	0.00	0.00	0.00	24.00	0.00	24.00		
	2	0.00	0.00	8.44	0.00	0.00	0.00	0.00	0.00	0.00	101.00	101.00		
9	1	0.00	0.00	8.44	0.00	0.00	0.00	0.00	0.00	0.00	101.00	101.00		
10	1	0.00	0.00	5.47	0.00	0.00	0.00	0.00	0.00	0.00	0.00	0.00		
11	1	0.00	0.00	6.44	0.00	0.00	0.00	0.00	0.00	0.00	64.00	64.00		
12	1	0.00	0.00	5.97	0.00	0.00	0.00	0.00	0.00	0.00	0.00	0.00		

Pedestrian Crossing Results

Pedestrian Crossings: Pedestrian summary

Time Segment	Crossing	Side	Degree of saturation (%)	Calculated Flow Entering (Ped/hr)	Calculated sat flow (Ped/hr)	Actual green (s per cycle)	Mean Delay Per Ped (s)	Mean max queue (Ped)	Weighted cost of delay (£ per hr)	Performance Index (£ per hr)
08:00-09:00	(ALL)	(ALL)	11	50	11000	5	55.58	1.60	10.96	10.96

Pedestrian Crossings: Flows and signals

Time Segment	Crossing	Side	Calculated flow entering (Ped/hr)	Calculated flow out (Ped/hr)	Flow discrepancy (Ped/hr)	Adjusted flow warning	Calculated sat flow (Ped/hr)	Calculated capacity (Ped/hr)	Degree of saturation (%)	DOS Threshold exceeded	Practical reserve capacity (%)	Mean modulus of error	Actual green (s per cycle)
08:00-09:00	(ALL)	(ALL)	50	50	0		11000	458	11		817	0.00	5

Pedestrian Crossings: Stops and delays

Time Segment	Crossing	Side	Mean Cruise Time per Ped (s)	Mean Delay per Ped (s)	Uniform delay (Ped-hr/hr)	Random plus oversat delay (Ped-hr/hr)	Weighted cost of delay (£ per hr)
08:00-09:00	1	1	5.67	55.58	0.77	0.00	10.96
		2	5.67	55.58	0.77	0.00	10.96
	2	1	6.33	55.58	0.77	0.00	10.96
		2	6.33	55.58	0.77	0.00	10.96
	3	1	6.33	55.58	0.77	0.00	10.96
		2	6.33	55.58	0.77	0.00	10.96
	4	1	5.67	55.58	0.77	0.00	10.96
		2	5.67	55.58	0.77	0.00	10.96

Pedestrian Crossings: Queues and blocking

Time Segment	Crossing	Side	Mean max queue (Ped)	Max queue storage (Ped)	Utilised storage (%)	Average storage excess queue (Ped)	Average limit excess queue (Ped)	Excess queue penalty (£ per hr)
08:00-09:00	(ALL)	(ALL)	1.60	10.00	15.97	0.00	0.00	0.00

Network Results

Network Results: Flows and signals

Time Segment	Calculated flow entering (Veh/hr)	Calculated flow out (Veh/hr)	Flow discrepancy (Veh/hr)	Adjusted flow warning	Degree of saturation (%)	DOS Threshold exceeded	Practical reserve capacity (%)	Actual green (s (per cycle))
08:00-09:00	5494	5494	0		87		15	1180

Network Results: Stops and delays

Time Segment	Mean Cruise Time per Veh (s)	Mean Delay per Veh (s)	Uniform delay (Veh-hr/hr)	Random plus oversat delay (Veh-hr/hr)	Weighted cost of delay (£ per hr)	Mean stops per Veh (%)	Uniform stops (Stops per hr)	Random stops (Stops per hr)	Weighted cost of stops (£ per hr)
08:00-09:00	13.41	22.36	25.85	8.27	484.51	32.25	1534.65	236.96	22.21

Network Results: Queues and blocking

Time Segment	Utilised storage (%)	Excess queue penalty (£ per hr)	Wasted time starvation (s (per cycle))	Wasted time blocking back (s (per cycle))	Wasted time total (s (per cycle))
08:00-09:00	347.93	0.00	129.00	165.00	294.00

Final Prediction Table

Traffic Stream Results

Arm	Traffic Stream	Name	Traffic node	SIGNALS		FLOWS		PERFORMANCE				PER PCU			QUEUES
				Controller stream	Phase	Calculated flow entering (Veh/hr)	Calculated sat flow (Veh/hr)	Actual green (s per cycle)	Wasted time total (s per cycle)	Degree of saturation (%)	Practical reserve capacity (%)	JourneyTime (s)	Mean Delay per Veh (s)	Mean stops per Veh (%)	Mean max queue (Veh)
A	1	(untitled)	1	1	D	308 <	1800	23	0.00	86	17	75.18	72.78	115.62	12.10 +
	2		1	1	C	76	1800	23	0.00	21	374	65.45	41.45	83.41	2.14
Ax	1	(untitled)				344	Unrestricted	120	25.00	0	Unrestricted	21.95	0.00	0.00	0.00
B	1	(untitled)	1	1	B	179	1800	39	0.00	30	235	54.89	30.89	73.40	4.44
	2		1	1	A	39	1800	5	3.00	43	131	72.50	70.34	107.76	1.42
Bx	1	(untitled)				798	Unrestricted	120	15.00	0	Unrestricted	21.41	0.00	0.00	0.00
C	1	(untitled)	1	1	D	223	1800	23	0.00	62	61	75.85	51.85	96.31	7.25
	2		1	1	C	311 <	1800	23	0.00	86	16	79.21	74.41	116.92	12.44 +
Cx	1	(untitled)				277	Unrestricted	120	59.00	0	Unrestricted	23.38	0.00	0.00	0.00
D	1	(untitled)	1	1	B	522	1800	39	0.00	87	15	79.97	55.97	106.71	18.91
	2		1	1	A	40	1800	5	3.00	44	125	74.64	71.04	108.28	1.46
Dx	1	(untitled)				279	Unrestricted	120	24.00	0	Unrestricted	21.24	0.00	0.00	0.00
9	1		1			384	Unrestricted	120	101.00	0	Unrestricted	5.82	0.00	0.00	0.00
10	1		1			218	Unrestricted	120	0.00	0	Unrestricted	3.78	0.00	0.00	0.00
11	1		1			534	Unrestricted	120	64.00	0	Unrestricted	4.44	0.00	0.00	0.00
12	1		1			562	Unrestricted	120	0.00	0	Unrestricted	4.12	0.00	0.00	0.00

Pedestrian Crossing Results

Pedestrian	Side	Name	Traffic node	SIGNALS		FLOWS		PERFORMANCE			PER PED		QUEUES	WEIGHTS	PEN
				Controller stream	Phase	Calculated Flow Entering (Ped/hr)	Calculated sat flow (Ped/hr)	Actual green (s per cycle)	Degree of saturation (%)	Practical reserve capacity (%)	JourneyTime (s)	Mean Delay per Ped (s)	Mean max queue (Ped)	Delay weighting (%)	Co tra pen (£ p
1	1	(untitled)	1	1	E	50	11000	5	11	817	61.25	55.58	1.60	100	0
	2	(untitled)	1	1	E	50	11000	5	11	817	61.25	55.58	1.60	100	0
2	1	(untitled)	1	1	E	50	11000	5	11	817	61.92	55.58	1.60	100	0
	2	(untitled)	1	1	E	50	11000	5	11	817	61.92	55.58	1.60	100	0
3	1	(untitled)	1	1	E	50	11000	5	11	817	61.92	55.58	1.60	100	0
	2	(untitled)	1	1	E	50	11000	5	11	817	61.92	55.58	1.60	100	0
4	1	(untitled)	1	1	E	50	11000	5	11	817	61.25	55.58	1.60	100	0
	2	(untitled)	1	1	E	50	11000	5	11	817	61.25	55.58	1.60	100	0

Network Results

	Distance travelled (PCU-km/hr)	Time spent (PCU-hr/hr)	Mean journey speed (kph)	Uniform delay (Veh-hr/hr)	Random plus oversat delay (Veh-hr/hr)	Weighted cost of delay (£ per hr)	Weighted cost of stops (£ per hr)	Excess queue penalty (£ per hr)	Performance Index (£ per hr)
Normal traffic	593.75	47.74	12.44	19.67	8.27	396.81	22.21	0.00	419.03
Bus	0.00	0.00	0.00	0.00	0.00	0.00	0.00	0.00	0.00
Tram	0.00	0.00	0.00	0.00	0.00	0.00	0.00	0.00	0.00
Pedestrians	3.40	6.84	0.50	6.18	0.00	87.70	0.00	0.00	87.70
TOTAL	597.15	54.58	10.94	25.85	8.27	484.51	22.21	0.00	506.72

- 1 < = adjusted flow warning (upstream links/traffic streams are over-saturated)
- 1 * = Traffic Stream - Normal, Bus or Tram Stop or Delay weighting has been set to a value other than 100%
- 1 ^ = Traffic Stream - Normal, Bus or Tram Stop or Delay Path weighting has been set to a value other than 100%
- 1 + = average link/traffic stream excess queue is greater than 0
- 1 P.I. = PERFORMANCE INDEX

A7 - DO SOMETHING 2039 D7 - DO SOMETHING 2039*

Summary

Data Errors and Warnings

No errors or warnings

Run Summary

Analysis set used	Run start time	Run finish time	Modelling start time (HH:mm)	Network Cycle Time (s)	Performance Index (£ per hr)	Total network delay (Veh-hr/hr)	Highest DOS (%)	Item with highest DOS	Number of oversaturated items	Percentage of oversaturated items (%)	Item with worst signalised PRC	Item with worst unsignalised PRC	Item with worst over PR
7	19/08/2020 12:04:21	19/08/2020 12:04:23	08:00	120	622.62	42.02	95.65	C/2	0	0	C/2	Dx/1	C/

Analysis Set Details

Name	Description	Demand set	Include in report	Locked
DO SOMETHING 2039		D7	✓	

Demand Set Details

Name	Description	Composite	Demand sets	Start time (HH:mm)	Locked
DO SOMETHING 2039				08:00	

Arms and Traffic Streams

Arms

Arm	Name	Description	Traffic node
A	(untitled)		1
Ax	(untitled)		
B	(untitled)		1
Bx	(untitled)		
C	(untitled)		1
Cx	(untitled)		
D	(untitled)		1
Dx	(untitled)		
9			1
10			1
11			1
12			1

Traffic Streams

Arm	Traffic Stream	Name	Description	Auto length	Length (m)	Has Saturation Flow	Saturation flow source	Saturation flow (PCU/hr)	Is signal controlled	Is give way	Traffic type	Allow Nearside Turn On Red
A	1	(untitled)			20.00	✓	Sum of lanes	1800	✓		Normal	
	2				200.00	✓	Sum of lanes	1800	✓		Normal	
Ax	1	(untitled)		✓	182.93						Normal	
B	1	(untitled)			200.00	✓	Sum of lanes	1800	✓		Normal	
	2				18.00	✓	Sum of lanes	1800	✓		Normal	
Bx	1	(untitled)		✓	178.44						Normal	
C	1	(untitled)			200.00	✓	Sum of lanes	1800	✓		Normal	
	2				40.00	✓	Sum of lanes	1800	✓		Normal	
Cx	1	(untitled)		✓	194.82						Normal	
D	1	(untitled)			200.00	✓	Sum of lanes	1800	✓		Normal	
	2				30.00	✓	Sum of lanes	1800	✓		Normal	
Dx	1	(untitled)		✓	177.04						Normal	
9	1			✓	48.53						Normal	
10	1			✓	31.46						Normal	
11	1			✓	37.01						Normal	
12	1			✓	34.36						Normal	

Lanes

Arm	Traffic Stream	Lane	Name	Description	Use RR67	Saturation flow (PCU/hr)
A	1	1	(untitled)			1800
	2	1	(untitled)			1800
Ax	1	1	(untitled)			
B	1	1	(untitled)			1800
	2	1	(untitled)			1800
Bx	1	1	(untitled)			
C	1	1	(untitled)			1800
	2	1	(untitled)			1800
Cx	1	1	(untitled)			
D	1	1	(untitled)			1800
	2	1	(untitled)			1800
Dx	1	1	(untitled)			
9	1	1	(untitled)			
10	1	1	(untitled)			
11	1	1	(untitled)			
12	1	1	(untitled)			

Modelling

Arm	Traffic Stream	Traffic model	Stop weighting multiplier (%)	Delay weighting multiplier (%)	Assignment Cost Weighting (%)	Exclude from results calculation	Max queue storage (PCU)	Has queue limit	Has degree of saturation limit
(ALL)	(ALL)	NetworkDefault	100	100	100		0.00		

Modelling - Advanced

Arm	Traffic Stream	Initial queue (PCU)	Type of Vehicle-in-Service	Vehicle-in-Service	Type of random parameter	Random parameter	Auto cycle time	Cycle time
(ALL)	(ALL)	0.00	NetworkDefault	Not-Included	NetworkDefault	0.50	✓	120

Normal traffic - Modelling

Arm	Traffic Stream	Stop weighting (%)	Delay weighting (%)
(ALL)	(ALL)	100	100

Normal traffic - Advanced

Arm	Traffic Stream	Dispersion type for Normal Traffic
(ALL)	(ALL)	NetworkDefault

Flows

Arm	Traffic Stream	Total Flow (Veh/hr)	Normal Flow (Veh/hr)
A	1	329	329
	2	82	82
Ax	1	367	367
B	1	192	192
	2	41	41
Bx	1	854	854
C	1	237	237
	2	330	330
Cx	1	295	295
D	1	562	562
	2	43	43
Dx	1	300	300
9	1	411	411
10	1	233	233
11	1	567	567
12	1	605	605

Signals

Arm	Traffic Stream	Controller stream	Phase	Second phase enabled
A	1	1	D	
	2	1	C	
B	1	1	B	
	2	1	A	
C	1	1	D	
	2	1	C	
D	1	1	B	
	2	1	A	

Pedestrian Crossings

Pedestrian Crossings

Crossing	Name	Description	Traffic node	Allow walk on red	Crossing type	Length (m)	Cruise time (seconds)	Cruise speed (kph)
1	(untitled)		1		Farside	7.00	4.67	5.40
2	(untitled)		1		Farside	8.00	5.33	5.40
3	(untitled)		1		Farside	8.00	5.33	5.40
4	(untitled)		1		Farside	7.00	4.67	5.40

Pedestrian Crossings - Signals

Crossing	Controller stream	Phase	Second phase enabled
(ALL)	1	E	

Pedestrian Crossings - Sides

Crossing	Side	Saturation flow (Ped/hr)
(ALL)	(ALL)	11000

Pedestrian Crossings - Modelling

Crossing	Side	Delay weighting (%)	Assignment Cost Weighting (%)	Exclude from results calculation	Max queue storage (Ped)	Has queue limit	Has degree of saturation limit
(ALL)	(ALL)	100	100		0.00		

Local OD Matrix - Local Matrix: 1

Local Matrix Options

OD Matrix	Name	Use for point to point table	Auto calculate	Allocation mode	Allow paths past exit locations	Allow looped paths on arms	Allow looped paths on traffic nodes	Copy flows	Matrix to copy flows from	Limit paths by length	Path length limit multiplier	Limit paths by number	Path number limit
1	(untitled)	✓	✓	Path Equalisation	✓		✓			✓	1.25		

Normal Input Flows (Veh/hr)

	To							
	1	2	3	4	5	6	7	8
From 1	0	32	205	330	0	0	0	0
2	43	0	121	441	0	0	0	0
3	246	82	0	83	0	0	0	0
4	6	186	41	0	0	0	0	0
5	0	0	0	0	0	0	0	0
6	0	0	0	0	0	0	0	0
7	0	0	0	0	0	0	0	0
8	0	0	0	0	0	0	0	0

Bus Input Flows not shown as they are blank.

Tram Input Flows not shown as they are blank.

Pedestrian Input Flows (Veh/hr)

	To							
	1	2	3	4	5	6	7	8
From 1	0	0	0	0	0	0	0	0
2	0	0	0	0	0	0	0	0
3	0	0	0	0	0	0	0	0
4	0	0	0	0	0	0	0	0
5	0	0	0	0	0	50	50	0
6	0	0	0	0	50	0	0	50
7	0	0	0	0	50	0	0	50
8	0	0	0	0	0	50	50	0

Locations

OD Matrix	Location	Name	Entries	Exits	Colour
1	1	(untitled)	11/1	Cx/1	#0000FF
	2	(untitled)	12/1	Dx/1	#FF0000
	3	(untitled)	9/1	Ax/1	#00FF00
	4	(untitled)	10/1	Bx/1	#FFFF00
	5	(untitled)	3:2E, 1:1E	3:2X, 1:1X	#FF00FF
	6	(untitled)	2:1E, 1:2E	2:1X, 1:2X	#008000
	7	(untitled)	4:2E, 3:1E	4:2X, 3:1X	#FFA500
	8	(untitled)	4:1E, 2:2E	4:1X, 2:2X	#00FFFF

Normal Paths and Flows

OD Matrix	Path	Description	From location	To location	Path items	Allocation type	Normal Calculated Flow (Veh/hr)
1	9		4	3	10/1, B/2, Ax/1	Normal	41
	10		3	4	9/1, A/1, Bx/1	Normal	83
	11		1	3	11/1, C/1, Ax/1	Normal	205
	12		1	4	11/1, C/2, Bx/1	Normal	330
	13		3	1	9/1, A/1, Cx/1	Normal	246
	14		4	1	10/1, B/1, Cx/1	Normal	6
	15		2	3	12/1, D/1, Ax/1	Normal	121
	16		2	4	12/1, D/1, Bx/1	Normal	441
	19		3	2	9/1, A/2, Dx/1	Normal	82
	20		4	2	10/1, B/1, Dx/1	Normal	186
	43		2	1	12/1, D/2, Cx/1	Normal	43
	44		1	2	11/1, C/1, Dx/1	Normal	32

Pedestrian Paths and Flows

OD Matrix	Path	Description	From location	To location	Path items	Allocation type	Pedestrian calculated flow (Ped/hr)
1	17		8	7	4:1E, 4:2X	Normal	50
	18		8	6	2:2E, 2:1X	Normal	50
	22		5	7	3:2E, 3:1X	Normal	50
	23		5	6	1:1E, 1:2X	Normal	50
	34		6	8	2:1E, 2:2X	Normal	50
	35		6	5	1:2E, 1:1X	Normal	50
	41		7	8	4:2E, 4:1X	Normal	50
	42		7	5	3:1E, 3:2X	Normal	50

Signal Timings

Network Default: 120s cycle time; 120 steps

Controller Stream 1

Controller Stream	Name	Description	Use sequence	Cycle time source	Cycle time (s)
1	(untitled)		1	NetworkDefault	120

Controller Stream 1 - Properties

Controller Stream	Manufacturer name	Type	Model number	(Telephone) Line Number	Site number	Grid reference	Gaining delay type
1	Unspecified						Relative

Controller Stream 1 - Optimisation

Controller Stream	Allow offset optimisation	Allow green split optimisation	Optimisation level	Auto redistribute	Enable stage constraint
1	✓	✓	Offsets And Green Splits	✓	

Phases

Controller Stream	Phase	Name	Minimum green (s)	Maximum green (s)	Relative start displacement (s)	Relative end displacement (s)	Type	Blackout Time (s)
1	A	(untitled)	5	70	0	0	Traffic	
	B	(untitled)	7	70	0	0	Traffic	
	C	(untitled)	7	70	0	0	Traffic	
	D	(untitled)	7	70	0	0	Traffic	
	E	(untitled)	5	5	0	0	Pedestrian	0

Library Stages

Controller Stream	Library Stage	Phases in stage	User stage minimum (s)
1	1	A	1
	2	B	1
	3	C	1
	4	D	1
	5	E	1

Stage Sequences

Controller Stream	Sequence	Name	Multiple cycling	Stage IDs	Stage ends
1	1	(untitled)	Single	1, 2, 3, 4, 5	114, 39, 66, 94, 104

Intergreen Matrix for Controller Stream 1

		To				
		A	B	C	D	E
From	A		5	5	5	5
	B	5		5	5	5
	C	5	5		5	5
	D	5	5	5		5
	E	5	5	5	5	

Banned Stage transitions for Controller Stream 1

		To				
		1	2	3	4	5
From	1					
	2					
	3					
	4					
	5					

Interstage Matrix for Controller Stream 1

		To				
		1	2	3	4	5
From	1	0	5	5	5	5
	2	5	0	5	5	5
	3	5	5	0	5	5
	4	5	5	5	0	5
	5	5	5	5	5	0

Resultant Stages

Controller Stream	Resultant Stage	Is base stage	Library Stage ID	Phases in this stage	Stage start (s)	Stage end (s)	Stage duration (s)	User stage minimum (s)	Stage minimum (s)
1	1	✓	1	A	109	114	5	1	5
	2	✓	2	B	119	39	40	1	7
	3	✓	3	C	44	66	22	1	7
	4	✓	4	D	71	94	23	1	7
	5	✓	5	E	99	104	5	1	5

Resultant Phase Green Periods

Controller Stream	Phase	Green period	Is base green period	Start time (s)	End time (s)	Duration (s)
1	A	1	✓	109	114	5
	B	1	✓	119	39	40
	C	1	✓	44	66	22
	D	1	✓	71	94	23
	E	1	✓	99	104	5

Traffic Stream Green Times

Arm	Traffic Stream	Traffic Node	Controller Stream	Phase	Green Period 1		
					Start	End	Duration
A	1	1	1	D	71	94	23
A	2	1	1	C	44	66	22
B	1	1	1	B	119	39	40
B	2	1	1	A	109	114	5
C	1	1	1	D	71	94	23
C	2	1	1	C	44	66	22
D	1	1	1	B	119	39	40
D	2	1	1	A	109	114	5

Phase Timings Diagram for Controller Stream 1

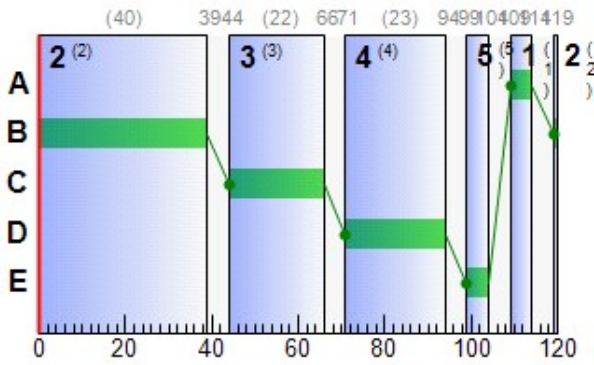

Stage Sequence Diagram for Controller Stream 1

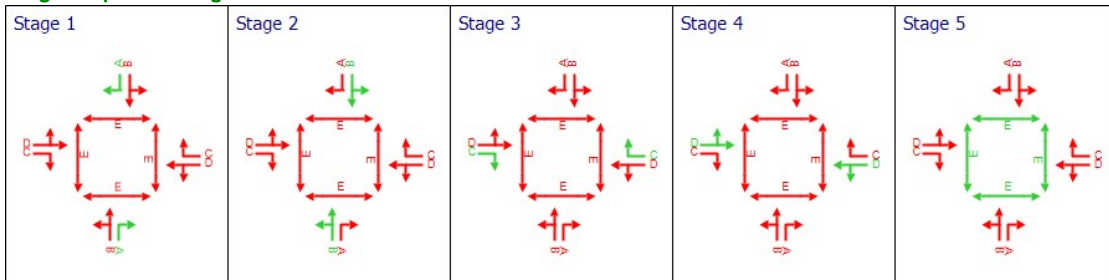

Resultant penalties

Time Segment	Controller stream	Phase min max penalty (£ per hr)	Intergreen broken penalty (£ per hr)	Stage constraint broken penalty (£ per hr)	Cost of controller stream penalties (£ per hr)
08:00-09:00	1	0.00	0.00	0.00	0.00

Traffic Stream Results

Traffic Stream Results: Vehicle summary

Time Segment	Arm	Traffic Stream	Degree of saturation (%)	Practical reserve capacity (%)	Calculated flow entering (Veh/hr)	Calculated sat flow (Veh/hr)	Actual green (s (per cycle))	Mean Delay per Veh (s)	Mean max queue (Veh)	Utilised storage (%)	Weighted cost of delay (£ per hr)	Weighted cost of stops (£ per hr)	Performance Index (£ per hr)	
08:00-09:00	A	1	91	9	329	1800	23	87.84	14.43	414.73	113.99	5.26	119.25	
		2	24	321	82	1800	22	42.72	2.34	6.72	13.82	0.87	14.69	
	Ax	1	0	Unrestricted	367	Unrestricted	120	0.00	0.00	0.00	0.00	0.00	0.00	0.00
		2	0	Unrestricted	367	Unrestricted	120	0.00	0.00	0.00	0.00	0.00	0.00	0.00
	B	1	31	220	192	1800	40	30.44	4.76	13.70	23.06	1.77	24.82	
		2	46	120	41	1800	5	71.76	1.51	48.14	11.61	0.56	12.16	
	Bx	1	0	Unrestricted	854	Unrestricted	120	0.00	0.00	0.00	0.00	0.00	0.00	0.00
		2	0	Unrestricted	854	Unrestricted	120	0.00	0.00	0.00	0.00	0.00	0.00	0.00
	C	1	66	52	237	1800	23	53.67	7.86	22.61	50.17	2.92	53.09	
		2	96	5	330	1800	22	109.26	16.43	236.20	142.22	5.89	148.11	
	Cx	1	0	Unrestricted	295	Unrestricted	120	0.00	0.00	0.00	0.00	0.00	0.00	0.00
		2	0	Unrestricted	295	Unrestricted	120	0.00	0.00	0.00	0.00	0.00	0.00	0.00
	D	1	91	9	562	1800	40	63.93	21.87	62.89	141.72	8.05	149.77	
		2	48	109	43	1800	5	73.28	1.60	30.63	12.43	0.59	13.02	
Dx	1	0	Unrestricted	300	Unrestricted	120	0.00	0.00	0.00	0.00	0.00	0.00	0.00	
	2	0	Unrestricted	300	Unrestricted	120	0.00	0.00	0.00	0.00	0.00	0.00	0.00	
9	1	0	Unrestricted	411	Unrestricted	120	0.00	0.00	0.00	0.00	0.00	0.00	0.00	
10	1	0	Unrestricted	233	Unrestricted	120	0.00	0.00	0.00	0.00	0.00	0.00	0.00	
11	1	0	Unrestricted	567	Unrestricted	120	0.00	0.00	0.00	0.00	0.00	0.00	0.00	
12	1	0	Unrestricted	605	Unrestricted	120	0.00	0.00	0.00	0.00	0.00	0.00	0.00	

Traffic Stream Results: Flows and signals

Time Segment	Arm	Traffic Stream	Calculated flow entering (Veh/hr)	Calculated flow out (Veh/hr)	Flow discrepancy (Veh/hr)	Adjusted flow warning	Calculated sat flow (Veh/hr)	Calculated capacity (Veh/hr)	Degree of saturation (%)	DOS Threshold exceeded	Practical reserve capacity (%)	Mean modulus of error	Actual green (s (per cycle))
08:00-09:00	A	1	329	329	0		1800	360	91		9	0.00	23
		2	82	82	0		1800	345	24		321	0.00	22
	Ax	1	367	367	0		Unrestricted	Unrestricted	0		Unrestricted	0.64	120
		2	367	367	0		Unrestricted	Unrestricted	0		Unrestricted	0.64	120
	B	1	192	192	0		1800	615	31		220	0.00	40
		2	41	41	0		1800	90	46		120	0.00	5
	Bx	1	854	854	0		Unrestricted	Unrestricted	0		Unrestricted	0.57	120
		2	854	854	0		Unrestricted	Unrestricted	0		Unrestricted	0.57	120
	C	1	237	237	0		1800	360	66		52	0.00	23
		2	330	330	0		1800	345	96		5	0.00	22
	Cx	1	295	295	0		Unrestricted	Unrestricted	0		Unrestricted	1.11	120
		2	295	295	0		Unrestricted	Unrestricted	0		Unrestricted	1.11	120
	D	1	562	562	0		1800	615	91		9	0.00	40
		2	43	43	0		1800	90	48		109	0.00	5
Dx	1	300	300	0		Unrestricted	Unrestricted	0		Unrestricted	0.78	120	
	2	300	300	0		Unrestricted	Unrestricted	0		Unrestricted	0.78	120	
9	1	411	411	0		Unrestricted	Unrestricted	0		Unrestricted	0.00	120	
10	1	233	233	0		Unrestricted	Unrestricted	0		Unrestricted	0.00	120	
11	1	567	567	0		Unrestricted	Unrestricted	0		Unrestricted	0.00	120	
12	1	605	605	0		Unrestricted	Unrestricted	0		Unrestricted	0.00	120	

Traffic Stream Results: Stops and delays

Time Segment	Arm	Traffic Stream	Mean Cruise Time per Veh (s)	Mean Delay per Veh (s)	Uniform delay (Veh-hr/hr)	Random plus oversat delay (Veh-hr/hr)	Weighted cost of delay (£ per hr)	Mean stops per Veh (%)	Uniform stops (Stops per hr)	Random stops (Stops per hr)	Weighted cost of stops (£ per hr)	
08:00-09:00	A	1	2.40	87.84	4.29	3.73	113.99	127.56	316.70	102.98	5.26	
		2	24.00	42.72	0.94	0.04	13.82	84.53	68.21	1.11	0.87	
	Ax	1	21.95	0.00	0.00	0.00	0.00	0.00	0.00	0.00	0.00	0.00
		2	24.00	30.44	1.55	0.07	23.06	73.33	138.68	2.12	1.77	
	B	1	24.00	30.44	1.55	0.07	23.06	73.33	138.68	2.12	1.77	
		2	2.16	71.76	0.63	0.19	11.61	108.82	39.23	5.39	0.56	
	Bx	1	21.41	0.00	0.00	0.00	0.00	0.00	0.00	0.00	0.00	0.00
		2	24.00	53.67	2.91	0.62	50.17	98.28	214.63	18.28	2.92	
	C	1	24.00	53.67	2.91	0.62	50.17	98.28	214.63	18.28	2.92	
		2	4.80	109.26	4.40	5.61	142.22	142.26	320.80	148.66	5.89	
	Cx	1	23.38	0.00	0.00	0.00	0.00	0.00	0.00	0.00	0.00	0.00
		2	24.00	63.93	5.90	4.08	141.72	114.26	526.23	115.91	8.05	
	D	1	24.00	63.93	5.90	4.08	141.72	114.26	526.23	115.91	8.05	
		2	3.60	73.28	0.66	0.21	12.43	109.96	41.14	6.14	0.59	
Dx	1	21.24	0.00	0.00	0.00	0.00	0.00	0.00	0.00	0.00	0.00	
	2	5.82	0.00	0.00	0.00	0.00	0.00	0.00	0.00	0.00	0.00	
9	1	5.82	0.00	0.00	0.00	0.00	0.00	0.00	0.00	0.00	0.00	
10	1	3.78	0.00	0.00	0.00	0.00	0.00	0.00	0.00	0.00	0.00	
11	1	4.44	0.00	0.00	0.00	0.00	0.00	0.00	0.00	0.00	0.00	
12	1	4.12	0.00	0.00	0.00	0.00	0.00	0.00	0.00	0.00	0.00	

Traffic Stream Results: Queues and blocking

Time Segment	Arm	Traffic Stream	queue (Veh)	max queue (Veh)	queue storage (Veh)	storage (%)	excess queue (Veh)	excess queue (Veh)	queue penalty (£ per hr)	starvation (s per cycle)	blocking back (s per cycle)	time total (s per cycle)	Estimated blocking
08:00-09:00	A	1	0.00	14.43	3.48	414.73	5.51	0.00	0.00	0.00	0.00	0.00	
		2	0.00	2.34	34.78	6.72	0.00	0.00	0.00	0.00	0.00	0.00	
	Ax	1	0.00	0.00	31.81	0.00	0.00	0.00	0.00	23.00	0.00	23.00	
		2	0.00	4.76	34.78	13.70	0.00	0.00	0.00	0.00	0.00	0.00	
	B	1	0.00	4.76	34.78	13.70	0.00	0.00	0.00	0.00	0.00	0.00	
		2	0.00	1.51	3.13	48.14	0.00	0.00	0.00	0.00	3.00	0.00	3.00
	Bx	1	0.00	0.00	31.03	0.00	0.00	0.00	0.00	0.00	13.00	0.00	13.00
		2	0.00	7.86	34.78	22.61	0.00	0.00	0.00	0.00	0.00	0.00	0.00
	C	1	0.00	7.86	34.78	22.61	0.00	0.00	0.00	0.00	0.00	0.00	0.00
		2	0.00	16.43	6.96	236.20	4.12	0.00	0.00	0.00	0.00	0.00	0.00
	Cx	1	0.00	0.00	33.88	0.00	0.00	0.00	0.00	0.00	59.00	0.00	59.00
		2	0.00	21.87	34.78	62.89	0.00	0.00	0.00	0.00	0.00	0.00	0.00
	D	1	0.00	1.60	5.22	30.63	0.00	0.00	0.00	0.00	3.00	0.00	3.00
		2	0.00	0.00	30.79	0.00	0.00	0.00	0.00	0.00	23.00	0.00	23.00
Dx	1	0.00	0.00	30.79	0.00	0.00	0.00	0.00	0.00	23.00	0.00	23.00	
	2	0.00	0.00	8.44	0.00	0.00	0.00	0.00	0.00	0.00	120.00	120.00	
9	1	0.00	0.00	8.44	0.00	0.00	0.00	0.00	0.00	0.00	120.00	120.00	
10	1	0.00	0.00	5.47	0.00	0.00	0.00	0.00	0.00	0.00	0.00	0.00	
11	1	0.00	0.00	6.44	0.00	0.00	0.00	0.00	0.00	0.00	104.00	104.00	
12	1	0.00	0.00	5.97	0.00	0.00	0.00	0.00	0.00	0.00	0.00	0.00	

Pedestrian Crossing Results

Pedestrian Crossings: Pedestrian summary

Time Segment	Crossing	Side	Degree of saturation (%)	Calculated Flow Entering (Ped/hr)	Calculated sat flow (Ped/hr)	Actual green (s per cycle)	Mean Delay Per Ped (s)	Mean max queue (Ped)	Weighted cost of delay (£ per hr)	Performance Index (£ per hr)
08:00-09:00	(ALL)	(ALL)	11	50	11000	5	55.58	1.60	10.96	10.96

Pedestrian Crossings: Flows and signals

Time Segment	Crossing	Side	Calculated flow entering (Ped/hr)	Calculated flow out (Ped/hr)	Flow discrepancy (Ped/hr)	Adjusted flow warning	Calculated sat flow (Ped/hr)	Calculated capacity (Ped/hr)	Degree of saturation (%)	DOS Threshold exceeded	Practical reserve capacity (%)	Mean modulus of error	Actual green (s per cycle)
08:00-09:00	(ALL)	(ALL)	50	50	0		11000	458	11		817	0.00	5

Pedestrian Crossings: Stops and delays

Time Segment	Crossing	Side	Mean Cruise Time per Ped (s)	Mean Delay per Ped (s)	Uniform delay (Ped-hr/hr)	Random plus oversat delay (Ped-hr/hr)	Weighted cost of delay (£ per hr)
08:00-09:00	1	1	5.67	55.58	0.77	0.00	10.96
		2	5.67	55.58	0.77	0.00	10.96
	2	1	6.33	55.58	0.77	0.00	10.96
		2	6.33	55.58	0.77	0.00	10.96
	3	1	6.33	55.58	0.77	0.00	10.96
		2	6.33	55.58	0.77	0.00	10.96
	4	1	5.67	55.58	0.77	0.00	10.96
		2	5.67	55.58	0.77	0.00	10.96

Pedestrian Crossings: Queues and blocking

Time Segment	Crossing	Side	Mean max queue (Ped)	Max queue storage (Ped)	Utilised storage (%)	Average storage excess queue (Ped)	Average limit excess queue (Ped)	Excess queue penalty (£ per hr)
08:00-09:00	(ALL)	(ALL)	1.60	10.00	15.97	0.00	0.00	0.00

Network Results

Network Results: Flows and signals

Time Segment	Calculated flow entering (Veh/hr)	Calculated flow out (Veh/hr)	Flow discrepancy (Veh/hr)	Adjusted flow warning	Degree of saturation (%)	DOS Threshold exceeded	Practical reserve capacity (%)	Actual green (s (per cycle))
08:00-09:00	5848	5848	0		96		5	1180

Network Results: Stops and delays

Time Segment	Mean Cruise Time per Veh (s)	Mean Delay per Veh (s)	Uniform delay (Veh-hr/hr)	Random plus oversat delay (Veh-hr/hr)	Weighted cost of delay (£ per hr)	Mean stops per Veh (%)	Uniform stops (Stops per hr)	Random stops (Stops per hr)	Weighted cost of stops (£ per hr)
08:00-09:00	13.45	25.87	27.47	14.55	596.71	35.33	1665.62	400.58	25.91

Network Results: Queues and blocking

Time Segment	Utilised storage (%)	Excess queue penalty (£ per hr)	Wasted time starvation (s (per cycle))	Wasted time blocking back (s (per cycle))	Wasted time total (s (per cycle))
08:00-09:00	414.73	0.00	124.00	224.00	348.00

Final Prediction Table

Traffic Stream Results

Arm	Traffic Stream	Name	Traffic node	SIGNALS		FLOWS		PERFORMANCE				PER PCU			QUEUES
				Controller stream	Phase	Calculated flow entering (Veh/hr)	Calculated sat flow (Veh/hr)	Actual green (s per cycle)	Wasted time total (s per cycle)	Degree of saturation (%)	Practical reserve capacity (%)	JourneyTime (s)	Mean Delay per Veh (s)	Mean stops per Veh (%)	Mean max queue (Veh)
A	1	(untitled)	1	1	D	329 <	1800	23	0.00	91	9	90.24	87.84	127.56	14.43 +
	2		1	1	C	82	1800	22	0.00	24	321	66.72	42.72	84.53	2.34
Ax	1	(untitled)				367	Unrestricted	120	23.00	0	Unrestricted	21.95	0.00	0.00	0.00
B	1	(untitled)	1	1	B	192	1800	40	0.00	31	220	54.44	30.44	73.33	4.76
	2		1	1	A	41	1800	5	3.00	46	120	73.92	71.76	108.82	1.51
Bx	1	(untitled)				854	Unrestricted	120	13.00	0	Unrestricted	21.41	0.00	0.00	0.00
C	1	(untitled)	1	1	D	237	1800	23	0.00	66	52	77.67	53.67	98.28	7.86
	2		1	1	C	330 <	1800	22	0.00	96	5	114.06	109.26	142.26	16.43 +
Cx	1	(untitled)				295	Unrestricted	120	59.00	0	Unrestricted	23.38	0.00	0.00	0.00
D	1	(untitled)	1	1	B	562	1800	40	0.00	91	9	87.93	63.93	114.26	21.87
	2		1	1	A	43	1800	5	3.00	48	109	76.88	73.28	109.96	1.60
Dx	1	(untitled)				300	Unrestricted	120	23.00	0	Unrestricted	21.24	0.00	0.00	0.00
9	1		1			411	Unrestricted	120	120.00	0	Unrestricted	5.82	0.00	0.00	0.00
10	1		1			233	Unrestricted	120	0.00	0	Unrestricted	3.78	0.00	0.00	0.00
11	1		1			567	Unrestricted	120	104.00	0	Unrestricted	4.44	0.00	0.00	0.00
12	1		1			605	Unrestricted	120	0.00	0	Unrestricted	4.12	0.00	0.00	0.00

Pedestrian Crossing Results

Pedestrian	Side	Name	Traffic node	SIGNALS		FLOWS		PERFORMANCE			PER PED		QUEUES	WEIGHTS	PEN
				Controller stream	Phase	Calculated Flow Entering (Ped/hr)	Calculated sat flow (Ped/hr)	Actual green (s per cycle)	Degree of saturation (%)	Practical reserve capacity (%)	JourneyTime (s)	Mean Delay per Ped (s)	Mean max queue (Ped)	Delay weighting (%)	Co tra pen (£ p
1	1	(untitled)	1	1	E	50	11000	5	11	817	61.25	55.58	1.60	100	0
	2	(untitled)	1	1	E	50	11000	5	11	817	61.25	55.58	1.60	100	0
2	1	(untitled)	1	1	E	50	11000	5	11	817	61.92	55.58	1.60	100	0
	2	(untitled)	1	1	E	50	11000	5	11	817	61.92	55.58	1.60	100	0
3	1	(untitled)	1	1	E	50	11000	5	11	817	61.92	55.58	1.60	100	0
	2	(untitled)	1	1	E	50	11000	5	11	817	61.92	55.58	1.60	100	0
4	1	(untitled)	1	1	E	50	11000	5	11	817	61.25	55.58	1.60	100	0
	2	(untitled)	1	1	E	50	11000	5	11	817	61.25	55.58	1.60	100	0

Network Results

	Distance travelled (PCU-km/hr)	Time spent (PCU-hr/hr)	Mean journey speed (kph)	Uniform delay (Veh-hr/hr)	Random plus oversat delay (Veh-hr/hr)	Weighted cost of delay (£ per hr)	Weighted cost of stops (£ per hr)	Excess queue penalty (£ per hr)	Performance Index (£ per hr)
Normal traffic	635.56	57.03	11.14	21.29	14.55	509.01	25.91	0.00	534.92
Bus	0.00	0.00	0.00	0.00	0.00	0.00	0.00	0.00	0.00
Tram	0.00	0.00	0.00	0.00	0.00	0.00	0.00	0.00	0.00
Pedestrians	3.40	6.84	0.50	6.18	0.00	87.70	0.00	0.00	87.70
TOTAL	638.96	63.87	10.00	27.47	14.55	596.71	25.91	0.00	622.62

- 1 < = adjusted flow warning (upstream links/traffic streams are over-saturated)
- 1 * = Traffic Stream - Normal, Bus or Tram Stop or Delay weighting has been set to a value other than 100%
- 1 ^ = Traffic Stream - Normal, Bus or Tram Stop or Delay Path weighting has been set to a value other than 100%
- 1 + = average link/traffic stream excess queue is greater than 0
- 1 P.I. = PERFORMANCE INDEX



TRANSYT 15
Version: 15.5.2.7994 © Copyright TRL Limited, 2018
For sales and distribution information, program advice and maintenance, contact TRL: +44 (0)1344 379777 software@trl.co.uk www.trisoftware.co.uk
The users of this computer program for the solution of an engineering problem are in no way relieved of their responsibility for the correctness of the solution

Filename: Junction 1 - PM.t15

Path: M:\Projects\12\12-081A - Dunshaughlin Phase 2 - Civils\Design\Traffic\Modelling AUGUST 2020\Junction 1

Report generation date: 19/08/2020 12:07:06

- »A1 - DO NOTHING 2020 : D1 - DO NOTHING 2020* :
- »A2 - DO NOTHING 2024 : D2 - DO NOTHING 2024* :
- »A3 - DO NOTHING 2029 : D3 - DO NOTHING 2029* :
- »A4 - DO NOTHING 2039 : D4 - DO NOTHING 2039* :
- »A5 - DO SOMETHING 2024 : D5 - DO SOMETHING 2024* :
- »A6 - DO SOMETHING 2029 : D6 - DO SOMETHING 2029* :
- »A7 - DO SOMETHING 2039 : D7 - DO SOMETHING 2039* :

File summary

File description

File title	(untitled)
Location	
Site number	
UTCRegion	
Driving side	Left
Date	06/12/2011
Version	
Status	(new file)
Identifier	
Client	
Jobnumber	
Enumerator	DOMAINf.silva
Description	

Model and Results

Enable controller offsets	Enable fuel consumption	Enable quick flares	Display journey time results	Display level of service results	Display blocking and starvation results	Display end of red and green queue results	Display excess queue results	Display separate uniform and random results	Display unweighted results	Display TRANSYT 12 style timings	Display effective greens in results	Display Red-With-Amber	Display End-Of-Green Amber
			✓		✓		✓	✓					

Units

Cost units	Speed units	Distance units	Fuel economy units	Fuel rate units	Mass units	Traffic units input	Traffic units results	Flow units	Average delay units	Total delay units	Rate of delay units
£	kph	m	mpg	l/h	kg	Veh	Veh	perHour	s	-Hour	perHour

Sorting

Show names instead of IDs	Sorting direction	Sorting type	Ignore prefixes when sorting	Analysis/demand set sorting	Link grouping	Source grouping	Colour Analysis/Demand Sets
	Ascending	Numerical		ID	Normal	Normal	✓

A1 - DO NOTHING 2020 D1 - DO NOTHING 2020*

Summary

Data Errors and Warnings

No errors or warnings

Run Summary

Analysis set used	Run start time	Run finish time	Modelling start time (HH:mm)	Network Cycle Time (s)	Performance Index (£ per hr)	Total network delay (Veh-hr/hr)	Highest DOS (%)	Item with highest DOS	Number of oversaturated items	Percentage of oversaturated items (%)	Item with worst signalised PRC	Item with worst unsignalised PRC	Item with worst over PR
1	19/08/2020 12:06:27	19/08/2020 12:06:28	17:00	120	358.56	24.15	73.09	A/1	0	0	A/1	Dx/1	A/

Analysis Set Details

Name	Description	Demand set	Include in report	Locked
DO NOTHING 2020		D1	✓	

Demand Set Details

Name	Description	Composite	Demand sets	Start time (HH:mm)	Locked
DO NOTHING 2020				17:00	

Arms and Traffic Streams

Arms

Arm	Name	Description	Traffic node
A	(untitled)		1
Ax	(untitled)		
B	(untitled)		1
Bx	(untitled)		
C	(untitled)		1
Cx	(untitled)		
D	(untitled)		1
Dx	(untitled)		
9			1
10			1
11			1
12			1

Traffic Streams

Arm	Traffic Stream	Name	Description	Auto length	Length (m)	Has Saturation Flow	Saturation flow source	Saturation flow (PCU/hr)	Is signal controlled	Is give way	Traffic type	Allow Nearside Turn On Red
A	1	(untitled)			20.00	✓	Sum of lanes	1800	✓		Normal	
	2				200.00	✓	Sum of lanes	1800	✓		Normal	
Ax	1	(untitled)		✓	182.93						Normal	
B	1	(untitled)			200.00	✓	Sum of lanes	1800	✓		Normal	
	2				18.00	✓	Sum of lanes	1800	✓		Normal	
Bx	1	(untitled)		✓	178.44						Normal	
C	1	(untitled)			200.00	✓	Sum of lanes	1800	✓		Normal	
	2				40.00	✓	Sum of lanes	1800	✓		Normal	
Cx	1	(untitled)		✓	194.82						Normal	
D	1	(untitled)			200.00	✓	Sum of lanes	1800	✓		Normal	
	2				30.00	✓	Sum of lanes	1800	✓		Normal	
Dx	1	(untitled)		✓	177.04						Normal	
9	1			✓	48.53						Normal	
10	1			✓	31.46						Normal	
11	1			✓	37.01						Normal	
12	1			✓	34.36						Normal	

Lanes

Arm	Traffic Stream	Lane	Name	Description	Use RR67	Saturation flow (PCU/hr)
A	1	1	(untitled)			1800
	2	1	(untitled)			1800
Ax	1	1	(untitled)			
B	1	1	(untitled)			1800
	2	1	(untitled)			1800
Bx	1	1	(untitled)			
C	1	1	(untitled)			1800
	2	1	(untitled)			1800
Cx	1	1	(untitled)			
D	1	1	(untitled)			1800
	2	1	(untitled)			1800
Dx	1	1	(untitled)			
9	1	1	(untitled)			
10	1	1	(untitled)			
11	1	1	(untitled)			
12	1	1	(untitled)			

Modelling

Arm	Traffic Stream	Traffic model	Stop weighting multiplier (%)	Delay weighting multiplier (%)	Assignment Cost Weighting (%)	Exclude from results calculation	Max queue storage (PCU)	Has queue limit	Has degree of saturation limit
(ALL)	(ALL)	NetworkDefault	100	100	100		0.00		

Modelling - Advanced

Arm	Traffic Stream	Initial queue (PCU)	Type of Vehicle-in-Service	Vehicle-in-Service	Type of random parameter	Random parameter	Auto cycle time	Cycle time
(ALL)	(ALL)	0.00	NetworkDefault	Not-Included	NetworkDefault	0.50	✓	120

Normal traffic - Modelling

Arm	Traffic Stream	Stop weighting (%)	Delay weighting (%)
(ALL)	(ALL)	100	100

Normal traffic - Advanced

Arm	Traffic Stream	Dispersion type for Normal Traffic
(ALL)	(ALL)	NetworkDefault

Flows

Arm	Traffic Stream	Total Flow (Veh/hr)	Normal Flow (Veh/hr)
A	1	296	296
	2	93	93
Ax	1	232	232
B	1	337	337
	2	85	85
Bx	1	457	457
C	1	112	112
	2	187	187
Cx	1	233	233
D	1	228	228
	2	28	28
Dx	1	444	444
9	1	389	389
10	1	422	422
11	1	299	299
12	1	256	256

Signals

Arm	Traffic Stream	Controller stream	Phase	Second phase enabled
A	1	1	D	
	2	1	C	
B	1	1	B	
	2	1	A	
C	1	1	D	
	2	1	C	
D	1	1	B	
	2	1	A	

Pedestrian Crossings

Pedestrian Crossings

Crossing	Name	Description	Traffic node	Allow walk on red	Crossing type	Length (m)	Cruise time (seconds)	Cruise speed (kph)
1	(untitled)		1		Farside	7.00	4.67	5.40
2	(untitled)		1		Farside	8.00	5.33	5.40
3	(untitled)		1		Farside	8.00	5.33	5.40
4	(untitled)		1		Farside	7.00	4.67	5.40

Pedestrian Crossings - Signals

Crossing	Controller stream	Phase	Second phase enabled
(ALL)	1	E	

Pedestrian Crossings - Sides

Crossing	Side	Saturation flow (Ped/hr)
(ALL)	(ALL)	11000

Pedestrian Crossings - Modelling

Crossing	Side	Delay weighting (%)	Assignment Cost Weighting (%)	Exclude from results calculation	Max queue storage (Ped)	Has queue limit	Has degree of saturation limit
(ALL)	(ALL)	100	100		0.00		

Local OD Matrix - Local Matrix: 1

Local Matrix Options

OD Matrix	Name	Use for point to point table	Auto calculate	Allocation mode	Allow paths past exit locations	Allow looped paths on arms	Allow looped paths on traffic nodes	Copy flows	Matrix to copy flows from	Limit paths by length	Path length limit multiplier	Limit paths by number	Path number limit
1	(untitled)	✓	✓	Path Equalisation	✓		✓			✓	1.25		

Normal Input Flows (Veh/hr)

	To							
	1	2	3	4	5	6	7	8
From 1	0	16	96	187	0	0	0	0
From 2	28	0	51	177	0	0	0	0
From 3	203	93	0	93	0	0	0	0
From 4	2	335	85	0	0	0	0	0
From 5	0	0	0	0	0	0	0	0
From 6	0	0	0	0	0	0	0	0
From 7	0	0	0	0	0	0	0	0
From 8	0	0	0	0	0	0	0	0

Bus Input Flows not shown as they are blank.

Tram Input Flows not shown as they are blank.

Pedestrian Input Flows (Veh/hr)

	To							
	1	2	3	4	5	6	7	8
From 1	0	0	0	0	0	0	0	0
From 2	0	0	0	0	0	0	0	0
From 3	0	0	0	0	0	0	0	0
From 4	0	0	0	0	0	0	0	0
From 5	0	0	0	0	0	50	50	0
From 6	0	0	0	0	50	0	0	50
From 7	0	0	0	0	50	0	0	50
From 8	0	0	0	0	0	50	50	0

Locations

OD Matrix	Location	Name	Entries	Exits	Colour
1	1	(untitled)	11/1	Cx/1	#0000FF
	2	(untitled)	12/1	Dx/1	#FF0000
	3	(untitled)	9/1	Ax/1	#00FF00
	4	(untitled)	10/1	Bx/1	#FFFF00
	5	(untitled)	3:2E, 1:1E	3:2X, 1:1X	#FF00FF
	6	(untitled)	2:1E, 1:2E	2:1X, 1:2X	#008000
	7	(untitled)	4:2E, 3:1E	4:2X, 3:1X	#FFA500
	8	(untitled)	4:1E, 2:2E	4:1X, 2:2X	#00FFFF

Normal Paths and Flows

OD Matrix	Path	Description	From location	To location	Path items	Allocation type	Normal Calculated Flow (Veh/hr)
1	9		4	3	10/1, B/2, Ax/1	Normal	85
	10		3	4	9/1, A/1, Bx/1	Normal	93
	11		1	3	11/1, C/1, Ax/1	Normal	96
	12		1	4	11/1, C/2, Bx/1	Normal	187
	13		3	1	9/1, A/1, Cx/1	Normal	203
	14		4	1	10/1, B/1, Cx/1	Normal	2
	15		2	3	12/1, D/1, Ax/1	Normal	51
	16		2	4	12/1, D/1, Bx/1	Normal	177
	19		3	2	9/1, A/2, Dx/1	Normal	93
	20		4	2	10/1, B/1, Dx/1	Normal	335
	43		2	1	12/1, D/2, Cx/1	Normal	28
	44		1	2	11/1, C/1, Dx/1	Normal	16

Pedestrian Paths and Flows

OD Matrix	Path	Description	From location	To location	Path items	Allocation type	Pedestrian calculated flow (Ped/hr)
1	17		8	7	4:1E, 4:2X	Normal	50
	18		8	6	2:2E, 2:1X	Normal	50
	22		5	7	3:2E, 3:1X	Normal	50
	23		5	6	1:1E, 1:2X	Normal	50
	34		6	8	2:1E, 2:2X	Normal	50
	35		6	5	1:2E, 1:1X	Normal	50
	41		7	8	4:2E, 4:1X	Normal	50
	42		7	5	3:1E, 3:2X	Normal	50

Signal Timings

Network Default: 120s cycle time; 120 steps

Controller Stream 1

Controller Stream	Name	Description	Use sequence	Cycle time source	Cycle time (s)
1	(untitled)		1	NetworkDefault	120

Controller Stream 1 - Properties

Controller Stream	Manufacturer name	Type	Model number	(Telephone) Line Number	Site number	Grid reference	Gaining delay type
1	Unspecified						Relative

Controller Stream 1 - Optimisation

Controller Stream	Allow offset optimisation	Allow green split optimisation	Optimisation level	Auto redistribute	Enable stage constraint
1	✓	✓	Offsets And Green Splits	✓	

Phases

Controller Stream	Phase	Name	Minimum green (s)	Maximum green (s)	Relative start displacement (s)	Relative end displacement (s)	Type	Blackout Time (s)
1	A	(untitled)	7	70	0	0	Traffic	
	B	(untitled)	7	70	0	0	Traffic	
	C	(untitled)	7	70	0	0	Traffic	
	D	(untitled)	7	70	0	0	Traffic	
	E	(untitled)	5	5	0	0	Pedestrian	0

Library Stages

Controller Stream	Library Stage	Phases in stage	User stage minimum (s)
1	1	A	1
	2	B	1
	3	C	1
	4	D	1
	5	E	1

Stage Sequences

Controller Stream	Sequence	Name	Multiple cycling	Stage IDs	Stage ends
1	1	(untitled)	Single	1, 2, 3, 4, 5	0, 43, 65, 96, 106

Intergreen Matrix for Controller Stream 1

		To				
		A	B	C	D	E
From	A		5	5	5	5
	B	5		5	5	5
	C	5	5		5	5
	D	5	5	5		5
	E	5	5	5	5	

Banned Stage transitions for Controller Stream 1

		To				
		1	2	3	4	5
From	1					
	2					
	3					
	4					
	5					

Interstage Matrix for Controller Stream 1

		To				
		1	2	3	4	5
From	1	0	5	5	5	5
	2	5	0	5	5	5
	3	5	5	0	5	5
	4	5	5	5	0	5
	5	5	5	5	5	0

Resultant Stages

Controller Stream	Resultant Stage	Is base stage	Library Stage ID	Phases in this stage	Stage start (s)	Stage end (s)	Stage duration (s)	User stage minimum (s)	Stage minimum (s)
1	1	✓	1	A	111	0	9	1	7
	2	✓	2	B	5	43	38	1	7
	3	✓	3	C	48	65	17	1	7
	4	✓	4	D	70	96	26	1	7
	5	✓	5	E	101	106	5	1	5

Resultant Phase Green Periods

Controller Stream	Phase	Green period	Is base green period	Start time (s)	End time (s)	Duration (s)
1	A	1	✓	111	0	9
	B	1	✓	5	43	38
	C	1	✓	48	65	17
	D	1	✓	70	96	26
	E	1	✓	101	106	5

Traffic Stream Green Times

Arm	Traffic Stream	Traffic Node	Controller Stream	Phase	Green Period 1		
					Start	End	Duration
A	1	1	1	D	70	96	26
A	2	1	1	C	48	65	17
B	1	1	1	B	5	43	38
B	2	1	1	A	111	0	9
C	1	1	1	D	70	96	26
C	2	1	1	C	48	65	17
D	1	1	1	B	5	43	38
D	2	1	1	A	111	0	9

Phase Timings Diagram for Controller Stream 1

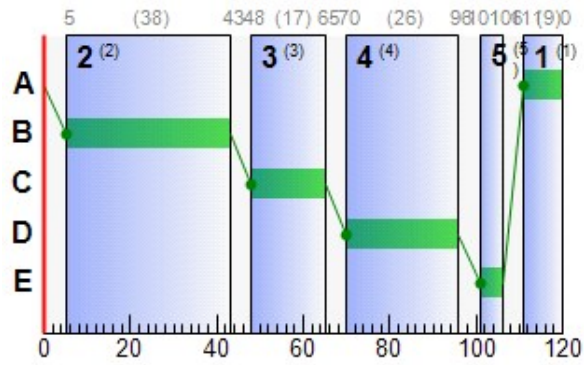

Stage Sequence Diagram for Controller Stream 1

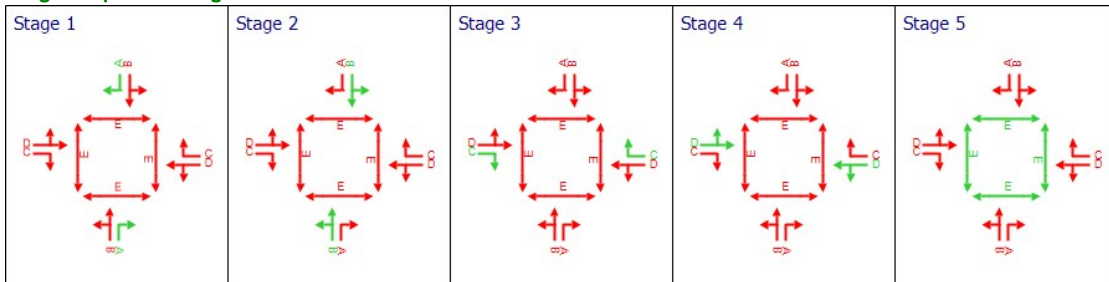

Resultant penalties

Time Segment	Controller stream	Phase min max penalty (£ per hr)	Intergreen broken penalty (£ per hr)	Stage constraint broken penalty (£ per hr)	Cost of controller stream penalties (£ per hr)
17:00-18:00	1	0.00	0.00	0.00	0.00

Traffic Stream Results

Traffic Stream Results: Vehicle summary

Time Segment	Arm	Traffic Stream	Degree of saturation (%)	Practical reserve capacity (%)	Calculated flow entering (Veh/hr)	Calculated sat flow (Veh/hr)	Actual green (s per cycle)	Mean Delay per Veh (s)	Mean max queue (Veh)	Utilised storage (%)	Weighted cost of delay (£ per hr)	Weighted cost of stops (£ per hr)	Performance Index (£ per hr)	
17:00-18:00	A	1	73	37	296	1800	26	54.84	10.09	290.06	64.03	3.74	67.77	
		2	34	190	93	1800	17	49.22	2.85	8.21	18.05	1.06	19.12	
	Ax	1	0	Unrestricted	232	Unrestricted	120	0.00	0.00	0.00	0.00	0.00	0.00	0.00
		2	0	Unrestricted	232	Unrestricted	120	0.00	0.00	0.00	0.00	0.00	0.00	0.00
	B	1	58	74	337	1800	38	37.79	9.66	27.76	50.23	3.58	53.81	
		2	57	76	85	1800	9	68.19	3.08	98.25	22.86	1.14	24.01	
	Bx	1	0	Unrestricted	457	Unrestricted	120	0.00	0.00	0.00	0.00	0.00	0.00	0.00
		2	0	Unrestricted	457	Unrestricted	120	0.00	0.00	0.00	0.00	0.00	0.00	0.00
	C	1	28	262	112	1800	26	40.13	3.13	9.01	17.73	1.16	18.89	
		2	69	44	187	1800	17	62.90	6.62	95.22	46.39	2.46	48.85	
	Cx	1	0	Unrestricted	233	Unrestricted	120	0.00	0.00	0.00	0.00	0.00	0.00	0.00
		2	0	Unrestricted	233	Unrestricted	120	0.00	0.00	0.00	0.00	0.00	0.00	0.00
	D	1	39	157	228	1800	38	33.27	5.95	17.11	29.92	2.21	32.13	
		2	19	436	28	1800	9	54.01	0.88	16.96	5.97	0.33	6.29	
Dx	1	0	Unrestricted	444	Unrestricted	120	0.00	0.00	0.00	0.00	0.00	0.00	0.00	
	2	0	Unrestricted	444	Unrestricted	120	0.00	0.00	0.00	0.00	0.00	0.00	0.00	
9	1	0	Unrestricted	389	Unrestricted	120	0.00	0.00	0.00	0.00	0.00	0.00	0.00	
10	1	0	Unrestricted	422	Unrestricted	120	0.00	0.00	0.00	0.00	0.00	0.00	0.00	
11	1	0	Unrestricted	299	Unrestricted	120	0.00	0.00	0.00	0.00	0.00	0.00	0.00	
12	1	0	Unrestricted	256	Unrestricted	120	0.00	0.00	0.00	0.00	0.00	0.00	0.00	

Traffic Stream Results: Flows and signals

Time Segment	Arm	Traffic Stream	Calculated flow entering (Veh/hr)	Calculated flow out (Veh/hr)	Flow discrepancy (Veh/hr)	Adjusted flow warning	Calculated sat flow (Veh/hr)	Calculated capacity (Veh/hr)	Degree of saturation (%)	DOS Threshold exceeded	Practical reserve capacity (%)	Mean modulus of error	Actual green (s per cycle)
17:00-18:00	A	1	296	296	0		1800	405	73		37	0.00	26
		2	93	93	0		1800	270	34		190	0.00	17
	Ax	1	232	232	0		Unrestricted	Unrestricted	0		Unrestricted	0.86	120
		2	232	232	0		Unrestricted	Unrestricted	0		Unrestricted	0.86	120
	B	1	337	337	0		1800	585	58		74	0.00	38
		2	85	85	0		1800	150	57		76	0.00	9
	Bx	1	457	457	0		Unrestricted	Unrestricted	0		Unrestricted	0.67	120
		2	457	457	0		Unrestricted	Unrestricted	0		Unrestricted	0.67	120
	C	1	112	112	0		1800	405	28		262	0.00	26
		2	187	187	0		1800	270	69		44	0.00	17
	Cx	1	233	233	0		Unrestricted	Unrestricted	0		Unrestricted	1.15	120
		2	233	233	0		Unrestricted	Unrestricted	0		Unrestricted	1.15	120
	D	1	228	228	0		1800	585	39		157	0.00	38
		2	28	28	0		1800	150	19		436	0.00	9
Dx	1	444	444	0		Unrestricted	Unrestricted	0		Unrestricted	0.92	120	
	2	444	444	0		Unrestricted	Unrestricted	0		Unrestricted	0.92	120	
9	1	389	389	0		Unrestricted	Unrestricted	0		Unrestricted	0.00	120	
10	1	422	422	0		Unrestricted	Unrestricted	0		Unrestricted	0.00	120	
11	1	299	299	0		Unrestricted	Unrestricted	0		Unrestricted	0.00	120	
12	1	256	256	0		Unrestricted	Unrestricted	0		Unrestricted	0.00	120	

Traffic Stream Results: Stops and delays

Time Segment	Arm	Traffic Stream	Mean Cruise Time per Veh (s)	Mean Delay per Veh (s)	Uniform delay (Veh-hr/hr)	Random plus oversat delay (Veh-hr/hr)	Weighted cost of delay (£ per hr)	Mean stops per Veh (%)	Uniform stops (Stops per hr)	Random stops (Stops per hr)	Weighted cost of stops (£ per hr)	
17:00-18:00	A	1	2.40	54.84	3.55	0.96	64.03	100.71	269.92	28.18	3.74	
		2	24.00	49.22	1.18	0.09	18.05	91.06	82.01	2.68	1.06	
	Ax	1	21.95	0.00	0.00	0.00	0.00	0.00	0.00	0.00	0.00	0.00
		2	24.00	37.79	3.15	0.39	50.23	84.76	274.09	11.55	3.58	
	B	1	2.16	68.19	1.25	0.36	22.86	107.17	80.62	10.47	1.14	
		2	21.41	0.00	0.00	0.00	0.00	0.00	0.00	0.00	0.00	
	Bx	1	24.00	40.13	1.20	0.05	17.73	82.73	91.08	1.58	1.16	
		2	4.80	62.90	2.51	0.75	46.39	104.90	174.22	21.95	2.46	
	C	1	23.38	0.00	0.00	0.00	0.00	0.00	0.00	0.00	0.00	
		2	24.00	33.27	1.98	0.12	29.92	77.25	172.43	3.71	2.21	
	Cx	1	3.60	54.01	0.40	0.02	5.97	93.79	25.62	0.64	0.33	
		2	21.24	0.00	0.00	0.00	0.00	0.00	0.00	0.00	0.00	
	D	1	5.82	0.00	0.00	0.00	0.00	0.00	0.00	0.00	0.00	
		2	3.78	0.00	0.00	0.00	0.00	0.00	0.00	0.00	0.00	
Dx	1	4.44	0.00	0.00	0.00	0.00	0.00	0.00	0.00	0.00		
	2	4.12	0.00	0.00	0.00	0.00	0.00	0.00	0.00	0.00		
9	1											
	2											
10	1											
	2											
11	1											
	2											
12	1											
	2											

Traffic Stream Results: Queues and blocking

Time Segment	Arm	Traffic Stream	Initial queue (Veh)	Mean max queue (Veh)	Max queue storage (Veh)	Utilised storage (%)	Average storage excess queue (Veh)	Average limit excess queue (Veh)	Excess queue penalty (£ per hr)	Wasted time starvation (s per cycle)	Wasted time blocking back (s per cycle)	Wasted time total (s per cycle)	Estimated blocking	
17:00-18:00	A	1	0.00	10.09	3.48	290.06	2.24	0.00	0.00	0.00	0.00	0.00		
		2	0.00	2.85	34.78	8.21	0.00	0.00	0.00	0.00	0.00	0.00	0.00	
	Ax	1	0.00	0.00	31.81	0.00	0.00	0.00	0.00	0.00	39.00	0.00	39.00	
		2	0.00	9.66	34.78	27.76	0.00	0.00	0.00	0.00	0.00	0.00	0.00	
	B	1	0.00	3.08	3.13	98.25	0.00	0.00	0.00	0.00	0.00	0.00	0.00	
		2	0.00	0.00	31.03	0.00	0.00	0.00	0.00	0.00	20.00	0.00	20.00	
	Bx	1	0.00	3.13	34.78	9.01	0.00	0.00	0.00	0.00	0.00	0.00	0.00	
		2	0.00	6.62	6.96	95.22	0.00	0.00	0.00	0.00	0.00	0.00	0.00	
	C	1	0.00	0.00	33.88	0.00	0.00	0.00	0.00	0.00	62.00	0.00	62.00	
		2	0.00	5.95	34.78	17.11	0.00	0.00	0.00	0.00	0.00	0.00	0.00	
	Cx	1	0.00	0.88	5.22	16.96	0.00	0.00	0.00	0.00	8.00	0.00	8.00	
		2	0.00	0.00	30.79	0.00	0.00	0.00	0.00	0.00	40.00	0.00	40.00	
	D	1	0.00	0.00	8.44	0.00	0.00	0.00	0.00	0.00	0.00	81.00	81.00	
		2	0.00	0.00	5.47	0.00	0.00	0.00	0.00	0.00	0.00	0.00	0.00	
Dx	1	0.00	0.00	6.44	0.00	0.00	0.00	0.00	0.00	0.00	0.00	0.00		
	2	0.00	0.00	5.97	0.00	0.00	0.00	0.00	0.00	0.00	0.00	0.00		
9	1													
	2													
10	1													
	2													
11	1													
	2													
12	1													
	2													

Pedestrian Crossing Results

Pedestrian Crossings: Pedestrian summary

Time Segment	Crossing	Side	Degree of saturation (%)	Calculated Flow Entering (Ped/hr)	Calculated sat flow (Ped/hr)	Actual green (s per cycle)	Mean Delay Per Ped (s)	Mean max queue (Ped)	Weighted cost of delay (£ per hr)	Performance Index (£ per hr)
17:00-18:00	(ALL)	(ALL)	11	50	11000	5	55.58	1.60	10.96	10.96

Pedestrian Crossings: Flows and signals

Time Segment	Crossing	Side	Calculated flow entering (Ped/hr)	Calculated flow out (Ped/hr)	Flow discrepancy (Ped/hr)	Adjusted flow warning	Calculated sat flow (Ped/hr)	Calculated capacity (Ped/hr)	Degree of saturation (%)	DOS Threshold exceeded	Practical reserve capacity (%)	Mean modulus of error	Actual green (s per cycle)
17:00-18:00	(ALL)	(ALL)	50	50	0		11000	458	11		817	0.00	5

Pedestrian Crossings: Stops and delays

Time Segment	Crossing	Side	Mean Cruise Time per Ped (s)	Mean Delay per Ped (s)	Uniform delay (Ped-hr/hr)	Random plus oversat delay (Ped-hr/hr)	Weighted cost of delay (£ per hr)
17:00-18:00	1	1	5.67	55.58	0.77	0.00	10.96
		2	5.67	55.58	0.77	0.00	10.96
	2	1	6.33	55.58	0.77	0.00	10.96
		2	6.33	55.58	0.77	0.00	10.96
	3	1	6.33	55.58	0.77	0.00	10.96
		2	6.33	55.58	0.77	0.00	10.96
	4	1	5.67	55.58	0.77	0.00	10.96
		2	5.67	55.58	0.77	0.00	10.96

Pedestrian Crossings: Queues and blocking

Time Segment	Crossing	Side	Mean max queue (Ped)	Max queue storage (Ped)	Utilised storage (%)	Average storage excess queue (Ped)	Average limit excess queue (Ped)	Excess queue penalty (£ per hr)
17:00-18:00	(ALL)	(ALL)	1.60	10.00	15.97	0.00	0.00	0.00

Network Results

Network Results: Flows and signals

Time Segment	Calculated flow entering (Veh/hr)	Calculated flow out (Veh/hr)	Flow discrepancy (Veh/hr)	Adjusted flow warning	Degree of saturation (%)	DOS Threshold exceeded	Practical reserve capacity (%)	Actual green (s (per cycle))
17:00-18:00	4498	4498	0		73		37	1180

Network Results: Stops and delays

Time Segment	Mean Cruise Time per Veh (s)	Mean Delay per Veh (s)	Uniform delay (Veh-hr/hr)	Random plus oversat delay (Veh-hr/hr)	Weighted cost of delay (£ per hr)	Mean stops per Veh (%)	Uniform stops (Stops per hr)	Random stops (Stops per hr)	Weighted cost of stops (£ per hr)
17:00-18:00	13.07	19.33	21.39	2.75	342.88	27.81	1170.00	80.76	15.68

Network Results: Queues and blocking

Time Segment	Utilised storage (%)	Excess queue penalty (£ per hr)	Wasted time starvation (s (per cycle))	Wasted time blocking back (s (per cycle))	Wasted time total (s (per cycle))
17:00-18:00	290.06	0.00	169.00	81.00	250.00

Final Prediction Table

Traffic Stream Results

Arm	Traffic Stream	Name	Traffic node	SIGNALS		FLOWS		PERFORMANCE				PER PCU			QUEUES
				Controller stream	Phase	Calculated flow entering (Veh/hr)	Calculated sat flow (Veh/hr)	Actual green (s per cycle)	Wasted time total (s per cycle)	Degree of saturation (%)	Practical reserve capacity (%)	JourneyTime (s)	Mean Delay per Veh (s)	Mean stops per Veh (%)	Mean max queue (Veh)
A	1	(untitled)	1	1	D	296 <	1800	26	0.00	73	37	57.24	54.84	100.71	10.09 +
	2		1	1	C	93	1800	17	0.00	34	190	73.22	49.22	91.06	2.85
Ax	1	(untitled)				232	Unrestricted	120	39.00	0	Unrestricted	21.95	0.00	0.00	0.00
B	1	(untitled)	1	1	B	337	1800	38	0.00	58	74	61.79	37.79	84.76	9.66
	2		1	1	A	85	1800	9	0.00	57	76	70.35	68.19	107.17	3.08
Bx	1	(untitled)				457	Unrestricted	120	20.00	0	Unrestricted	21.41	0.00	0.00	0.00
C	1	(untitled)	1	1	D	112	1800	26	0.00	28	262	64.13	40.13	82.73	3.13
	2		1	1	C	187	1800	17	0.00	69	44	67.70	62.90	104.90	6.62
Cx	1	(untitled)				233	Unrestricted	120	62.00	0	Unrestricted	23.38	0.00	0.00	0.00
D	1	(untitled)	1	1	B	228	1800	38	0.00	39	157	57.27	33.27	77.25	5.95
	2		1	1	A	28	1800	9	8.00	19	436	57.61	54.01	93.79	0.88
Dx	1	(untitled)				444	Unrestricted	120	40.00	0	Unrestricted	21.24	0.00	0.00	0.00
9	1		1			389	Unrestricted	120	81.00	0	Unrestricted	5.82	0.00	0.00	0.00
10	1		1			422	Unrestricted	120	0.00	0	Unrestricted	3.78	0.00	0.00	0.00
11	1		1			299	Unrestricted	120	0.00	0	Unrestricted	4.44	0.00	0.00	0.00
12	1		1			256	Unrestricted	120	0.00	0	Unrestricted	4.12	0.00	0.00	0.00

Pedestrian Crossing Results

Pedestrian	Side	Name	Traffic node	SIGNALS		FLOWS		PERFORMANCE			PER PED		QUEUES	WEIGHTS	PEN
				Controller stream	Phase	Calculated Flow Entering (Ped/hr)	Calculated sat flow (Ped/hr)	Actual green (s per cycle)	Degree of saturation (%)	Practical reserve capacity (%)	JourneyTime (s)	Mean Delay per Ped (s)	Mean max queue (Ped)	Delay weighting (%)	Co tra pen (£ p
1	1	(untitled)	1	1	E	50	11000	5	11	817	61.25	55.58	1.60	100	0
	2	(untitled)	1	1	E	50	11000	5	11	817	61.25	55.58	1.60	100	0
2	1	(untitled)	1	1	E	50	11000	5	11	817	61.92	55.58	1.60	100	0
	2	(untitled)	1	1	E	50	11000	5	11	817	61.92	55.58	1.60	100	0
3	1	(untitled)	1	1	E	50	11000	5	11	817	61.92	55.58	1.60	100	0
	2	(untitled)	1	1	E	50	11000	5	11	817	61.92	55.58	1.60	100	0
4	1	(untitled)	1	1	E	50	11000	5	11	817	61.25	55.58	1.60	100	0
	2	(untitled)	1	1	E	50	11000	5	11	817	61.25	55.58	1.60	100	0

Network Results

	Distance travelled (PCU-km/hr)	Time spent (PCU-hr/hr)	Mean journey speed (kph)	Uniform delay (Veh-hr/hr)	Random plus oversat delay (Veh-hr/hr)	Weighted cost of delay (£ per hr)	Weighted cost of stops (£ per hr)	Excess queue penalty (£ per hr)	Performance Index (£ per hr)
Normal traffic	469.77	33.63	13.97	15.22	2.75	255.18	15.68	0.00	270.87
Bus	0.00	0.00	0.00	0.00	0.00	0.00	0.00	0.00	0.00
Tram	0.00	0.00	0.00	0.00	0.00	0.00	0.00	0.00	0.00
Pedestrians	3.40	6.84	0.50	6.18	0.00	87.70	0.00	0.00	87.70
TOTAL	473.17	40.47	11.69	21.39	2.75	342.88	15.68	0.00	358.56

- 1 < = adjusted flow warning (upstream links/traffic streams are over-saturated)
- 1 * = Traffic Stream - Normal, Bus or Tram Stop or Delay weighting has been set to a value other than 100%
- 1 ^ = Traffic Stream - Normal, Bus or Tram Stop or Delay Path weighting has been set to a value other than 100%
- 1 + = average link/traffic stream excess queue is greater than 0
- 1 P.I. = PERFORMANCE INDEX

A2 - DO NOTHING 2024 D2 - DO NOTHING 2024*

Summary

Data Errors and Warnings

No errors or warnings

Run Summary

Analysis set used	Run start time	Run finish time	Modelling start time (HH:mm)	Network Cycle Time (s)	Performance Index (£ per hr)	Total network delay (Veh-hr/hr)	Highest DOS (%)	Item with highest DOS	Number of oversaturated items	Percentage of oversaturated items (%)	Item with worst signalised PRC	Item with worst unsignalised PRC	Item with worst over PR
2	19/08/2020 12:06:29	19/08/2020 12:06:30	17:00	120	400.05	26.93	77.78	C/2	0	0	C/2	Dx/1	C/

Analysis Set Details

Name	Description	Demand set	Include in report	Locked
DO NOTHING 2024		D2	✓	

Demand Set Details

Name	Description	Composite	Demand sets	Start time (HH:mm)	Locked
DO NOTHING 2024				17:00	

Arms and Traffic Streams

Arms

Arm	Name	Description	Traffic node
A	(untitled)		1
Ax	(untitled)		
B	(untitled)		1
Bx	(untitled)		
C	(untitled)		1
Cx	(untitled)		
D	(untitled)		1
Dx	(untitled)		
9			1
10			1
11			1
12			1

Traffic Streams

Arm	Traffic Stream	Name	Description	Auto length	Length (m)	Has Saturation Flow	Saturation flow source	Saturation flow (PCU/hr)	Is signal controlled	Is give way	Traffic type	Allow Nearside Turn On Red
A	1	(untitled)			20.00	✓	Sum of lanes	1800	✓		Normal	
	2				200.00	✓	Sum of lanes	1800	✓		Normal	
Ax	1	(untitled)		✓	182.93						Normal	
B	1	(untitled)			200.00	✓	Sum of lanes	1800	✓		Normal	
	2				18.00	✓	Sum of lanes	1800	✓		Normal	
Bx	1	(untitled)		✓	178.44						Normal	
C	1	(untitled)			200.00	✓	Sum of lanes	1800	✓		Normal	
	2				40.00	✓	Sum of lanes	1800	✓		Normal	
Cx	1	(untitled)		✓	194.82						Normal	
D	1	(untitled)			200.00	✓	Sum of lanes	1800	✓		Normal	
	2				30.00	✓	Sum of lanes	1800	✓		Normal	
Dx	1	(untitled)		✓	177.04						Normal	
9	1			✓	48.53						Normal	
10	1			✓	31.46						Normal	
11	1			✓	37.01						Normal	
12	1			✓	34.36						Normal	

Lanes

Arm	Traffic Stream	Lane	Name	Description	Use RR67	Saturation flow (PCU/hr)
A	1	1	(untitled)			1800
	2	1	(untitled)			1800
Ax	1	1	(untitled)			
B	1	1	(untitled)			1800
	2	1	(untitled)			1800
Bx	1	1	(untitled)			
C	1	1	(untitled)			1800
	2	1	(untitled)			1800
Cx	1	1	(untitled)			
D	1	1	(untitled)			1800
	2	1	(untitled)			1800
Dx	1	1	(untitled)			
9	1	1	(untitled)			
10	1	1	(untitled)			
11	1	1	(untitled)			
12	1	1	(untitled)			

Modelling

Arm	Traffic Stream	Traffic model	Stop weighting multiplier (%)	Delay weighting multiplier (%)	Assignment Cost Weighting (%)	Exclude from results calculation	Max queue storage (PCU)	Has queue limit	Has degree of saturation limit
(ALL)	(ALL)	NetworkDefault	100	100	100		0.00		

Modelling - Advanced

Arm	Traffic Stream	Initial queue (PCU)	Type of Vehicle-in-Service	Vehicle-in-Service	Type of random parameter	Random parameter	Auto cycle time	Cycle time
(ALL)	(ALL)	0.00	NetworkDefault	Not-Included	NetworkDefault	0.50	✓	120

Normal traffic - Modelling

Arm	Traffic Stream	Stop weighting (%)	Delay weighting (%)
(ALL)	(ALL)	100	100

Normal traffic - Advanced

Arm	Traffic Stream	Dispersion type for Normal Traffic
(ALL)	(ALL)	NetworkDefault

Flows

Arm	Traffic Stream	Total Flow (Veh/hr)	Normal Flow (Veh/hr)
A	1	325	325
	2	100	100
Ax	1	254	254
B	1	361	361
	2	91	91
Bx	1	500	500
C	1	126	126
	2	210	210
Cx	1	258	258
D	1	245	245
	2	31	31
Dx	1	477	477
9	1	425	425
10	1	452	452
11	1	336	336
12	1	276	276

Signals

Arm	Traffic Stream	Controller stream	Phase	Second phase enabled
A	1	1	D	
	2	1	C	
B	1	1	B	
	2	1	A	
C	1	1	D	
	2	1	C	
D	1	1	B	
	2	1	A	

Pedestrian Crossings

Pedestrian Crossings

Crossing	Name	Description	Traffic node	Allow walk on red	Crossing type	Length (m)	Cruise time (seconds)	Cruise speed (kph)
1	(untitled)		1		Farside	7.00	4.67	5.40
2	(untitled)		1		Farside	8.00	5.33	5.40
3	(untitled)		1		Farside	8.00	5.33	5.40
4	(untitled)		1		Farside	7.00	4.67	5.40

Pedestrian Crossings - Signals

Crossing	Controller stream	Phase	Second phase enabled
(ALL)	1	E	

Pedestrian Crossings - Sides

Crossing	Side	Saturation flow (Ped/hr)
(ALL)	(ALL)	11000

Pedestrian Crossings - Modelling

Crossing	Side	Delay weighting (%)	Assignment Cost Weighting (%)	Exclude from results calculation	Max queue storage (Ped)	Has queue limit	Has degree of saturation limit
(ALL)	(ALL)	100	100		0.00		

Local OD Matrix - Local Matrix: 1

Local Matrix Options

OD Matrix	Name	Use for point to point table	Auto calculate	Allocation mode	Allow paths past exit locations	Allow looped paths on arms	Allow looped paths on traffic nodes	Copy flows	Matrix to copy flows from	Limit paths by length	Path length limit multiplier	Limit paths by number	Path number limit
1	(untitled)	✓	✓	Path Equalisation	✓		✓			✓	1.25		

Normal Input Flows (Veh/hr)

	To							
	1	2	3	4	5	6	7	8
From 1	0	18	108	210	0	0	0	0
From 2	31	0	55	190	0	0	0	0
From 3	225	100	0	100	0	0	0	0
From 4	2	359	91	0	0	0	0	0
From 5	0	0	0	0	0	0	0	0
From 6	0	0	0	0	0	0	0	0
From 7	0	0	0	0	0	0	0	0
From 8	0	0	0	0	0	0	0	0

Bus Input Flows not shown as they are blank.

Tram Input Flows not shown as they are blank.

Pedestrian Input Flows (Veh/hr)

	To							
	1	2	3	4	5	6	7	8
From 1	0	0	0	0	0	0	0	0
From 2	0	0	0	0	0	0	0	0
From 3	0	0	0	0	0	0	0	0
From 4	0	0	0	0	0	0	0	0
From 5	0	0	0	0	0	50	50	0
From 6	0	0	0	0	50	0	0	50
From 7	0	0	0	0	50	0	0	50
From 8	0	0	0	0	0	50	50	0

Locations

OD Matrix	Location	Name	Entries	Exits	Colour
1	1	(untitled)	11/1	Cx/1	#0000FF
	2	(untitled)	12/1	Dx/1	#FF0000
	3	(untitled)	9/1	Ax/1	#00FF00
	4	(untitled)	10/1	Bx/1	#FFFF00
	5	(untitled)	3:2E, 1:1E	3:2X, 1:1X	#FF00FF
	6	(untitled)	2:1E, 1:2E	2:1X, 1:2X	#008000
	7	(untitled)	4:2E, 3:1E	4:2X, 3:1X	#FFA500
	8	(untitled)	4:1E, 2:2E	4:1X, 2:2X	#00FFFF

Normal Paths and Flows

OD Matrix	Path	Description	From location	To location	Path items	Allocation type	Normal Calculated Flow (Veh/hr)
1	9		4	3	10/1, B/2, Ax/1	Normal	91
	10		3	4	9/1, A/1, Bx/1	Normal	100
	11		1	3	11/1, C/1, Ax/1	Normal	108
	12		1	4	11/1, C/2, Bx/1	Normal	210
	13		3	1	9/1, A/1, Cx/1	Normal	225
	14		4	1	10/1, B/1, Cx/1	Normal	2
	15		2	3	12/1, D/1, Ax/1	Normal	55
	16		2	4	12/1, D/1, Bx/1	Normal	190
	19		3	2	9/1, A/2, Dx/1	Normal	100
	20		4	2	10/1, B/1, Dx/1	Normal	359
	43		2	1	12/1, D/2, Cx/1	Normal	31
	44		1	2	11/1, C/1, Dx/1	Normal	18

Pedestrian Paths and Flows

OD Matrix	Path	Description	From location	To location	Path items	Allocation type	Pedestrian calculated flow (Ped/hr)
1	17		8	7	4:1E, 4:2X	Normal	50
	18		8	6	2:2E, 2:1X	Normal	50
	22		5	7	3:2E, 3:1X	Normal	50
	23		5	6	1:1E, 1:2X	Normal	50
	34		6	8	2:1E, 2:2X	Normal	50
	35		6	5	1:2E, 1:1X	Normal	50
	41		7	8	4:2E, 4:1X	Normal	50
	42		7	5	3:1E, 3:2X	Normal	50

Signal Timings

Network Default: 120s cycle time; 120 steps

Controller Stream 1

Controller Stream	Name	Description	Use sequence	Cycle time source	Cycle time (s)
1	(untitled)		1	NetworkDefault	120

Controller Stream 1 - Properties

Controller Stream	Manufacturer name	Type	Model number	(Telephone) Line Number	Site number	Grid reference	Gaining delay type
1	Unspecified						Relative

Controller Stream 1 - Optimisation

Controller Stream	Allow offset optimisation	Allow green split optimisation	Optimisation level	Auto redistribute	Enable stage constraint
1	✓	✓	Offsets And Green Splits	✓	

Phases

Controller Stream	Phase	Name	Minimum green (s)	Maximum green (s)	Relative start displacement (s)	Relative end displacement (s)	Type	Blackout Time (s)
1	A	(untitled)	7	70	0	0	Traffic	
	B	(untitled)	7	70	0	0	Traffic	
	C	(untitled)	7	70	0	0	Traffic	
	D	(untitled)	7	70	0	0	Traffic	
	E	(untitled)	5	5	0	0	Pedestrian	0

Library Stages

Controller Stream	Library Stage	Phases in stage	User stage minimum (s)
1	1	A	1
	2	B	1
	3	C	1
	4	D	1
	5	E	1

Stage Sequences

Controller Stream	Sequence	Name	Multiple cycling	Stage IDs	Stage ends
1	1	(untitled)	Single	1, 2, 3, 4, 5	0, 42, 64, 96, 106

Intergreen Matrix for Controller Stream 1

		To				
		A	B	C	D	E
From	A		5	5	5	5
	B	5		5	5	5
	C	5	5		5	5
	D	5	5	5		5
	E	5	5	5	5	

Banned Stage transitions for Controller Stream 1

		To				
		1	2	3	4	5
From	1					
	2					
	3					
	4					
	5					

Interstage Matrix for Controller Stream 1

		To				
		1	2	3	4	5
From	1	0	5	5	5	5
	2	5	0	5	5	5
	3	5	5	0	5	5
	4	5	5	5	0	5
	5	5	5	5	5	0

Resultant Stages

Controller Stream	Resultant Stage	Is base stage	Library Stage ID	Phases in this stage	Stage start (s)	Stage end (s)	Stage duration (s)	User stage minimum (s)	Stage minimum (s)
1	1	✓	1	A	111	0	9	1	7
	2	✓	2	B	5	42	37	1	7
	3	✓	3	C	47	64	17	1	7
	4	✓	4	D	69	96	27	1	7
	5	✓	5	E	101	106	5	1	5

Resultant Phase Green Periods

Controller Stream	Phase	Green period	Is base green period	Start time (s)	End time (s)	Duration (s)
1	A	1	✓	111	0	9
	B	1	✓	5	42	37
	C	1	✓	47	64	17
	D	1	✓	69	96	27
	E	1	✓	101	106	5

Traffic Stream Green Times

Arm	Traffic Stream	Traffic Node	Controller Stream	Phase	Green Period 1		
					Start	End	Duration
A	1	1	1	D	69	96	27
A	2	1	1	C	47	64	17
B	1	1	1	B	5	42	37
B	2	1	1	A	111	0	9
C	1	1	1	D	69	96	27
C	2	1	1	C	47	64	17
D	1	1	1	B	5	42	37
D	2	1	1	A	111	0	9

Phase Timings Diagram for Controller Stream 1

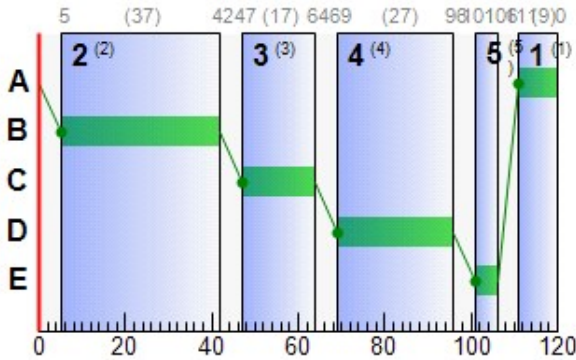

Stage Sequence Diagram for Controller Stream 1

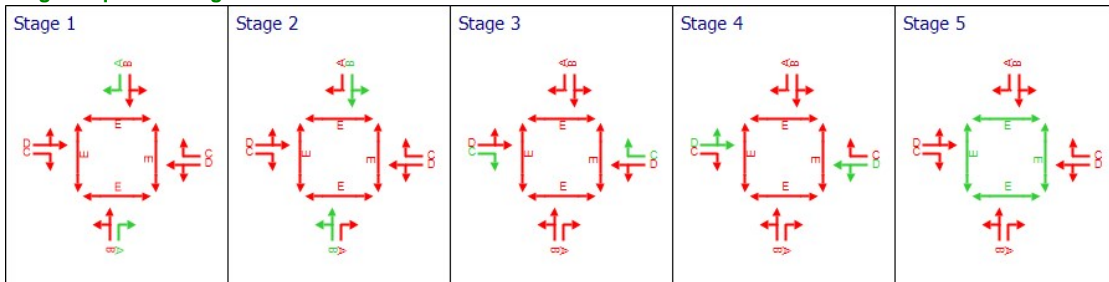

Resultant penalties

Time Segment	Controller stream	Phase min max penalty (£ per hr)	Intergreen broken penalty (£ per hr)	Stage constraint broken penalty (£ per hr)	Cost of controller stream penalties (£ per hr)
17:00-18:00	1	0.00	0.00	0.00	0.00

Traffic Stream Results

Traffic Stream Results: Vehicle summary

Time Segment	Arm	Traffic Stream	Degree of saturation (%)	Practical reserve capacity (%)	Calculated flow entering (Veh/hr)	Calculated sat flow (Veh/hr)	Actual green (s per cycle)	Mean Delay per Veh (s)	Mean max queue (Veh)	Utilised storage (%)	Weighted cost of delay (£ per hr)	Weighted cost of stops (£ per hr)	Performance Index (£ per hr)	
17:00-18:00	A	1	77	29	325	1800	27	57.10	11.38	327.18	73.20	4.21	77.41	
		2	37	170	100	1800	17	49.80	3.08	8.86	19.64	1.15	20.79	
	Ax	1	0	Unrestricted	254	Unrestricted	120	0.00	0.00	0.00	0.00	0.00	0.00	0.00
		2	0	Unrestricted	254	Unrestricted	120	0.00	0.00	0.00	0.00	0.00	0.00	0.00
	B	1	63	58	361	1800	37	40.44	10.77	30.96	57.59	3.99	61.58	
		2	61	65	91	1800	9	70.98	3.36	107.29	25.48	1.25	26.72	
	Bx	1	0	Unrestricted	500	Unrestricted	120	0.00	0.00	0.00	0.00	0.00	0.00	0.00
		2	0	Unrestricted	500	Unrestricted	120	0.00	0.00	0.00	0.00	0.00	0.00	0.00
	C	1	30	233	126	1800	27	39.76	3.49	10.05	19.76	1.30	21.06	
		2	78	29	210	1800	17	70.93	7.98	114.75	58.75	2.95	61.70	
	Cx	1	0	Unrestricted	258	Unrestricted	120	0.00	0.00	0.00	0.00	0.00	0.00	0.00
		2	0	Unrestricted	258	Unrestricted	120	0.00	0.00	0.00	0.00	0.00	0.00	0.00
	D	1	43	133	245	1800	37	34.80	6.56	18.86	33.63	2.44	36.07	
		2	21	384	31	1800	9	54.43	0.98	18.83	6.66	0.37	7.02	
Dx	1	0	Unrestricted	477	Unrestricted	120	0.00	0.00	0.00	0.00	0.00	0.00	0.00	
	2	0	Unrestricted	477	Unrestricted	120	0.00	0.00	0.00	0.00	0.00	0.00	0.00	
9	1	0	Unrestricted	425	Unrestricted	120	0.00	0.00	0.00	0.00	0.00	0.00	0.00	
10	1	0	Unrestricted	452	Unrestricted	120	0.00	0.00	0.00	0.00	0.00	0.00	0.00	
11	1	0	Unrestricted	336	Unrestricted	120	0.00	0.00	0.00	0.00	0.00	0.00	0.00	
12	1	0	Unrestricted	276	Unrestricted	120	0.00	0.00	0.00	0.00	0.00	0.00	0.00	

Traffic Stream Results: Flows and signals

Time Segment	Arm	Traffic Stream	Calculated flow entering (Veh/hr)	Calculated flow out (Veh/hr)	Flow discrepancy (Veh/hr)	Adjusted flow warning	Calculated sat flow (Veh/hr)	Calculated capacity (Veh/hr)	Degree of saturation (%)	DOS Threshold exceeded	Practical reserve capacity (%)	Mean modulus of error	Actual green (s per cycle)
17:00-18:00	A	1	325	325	0		1800	420	77		29	0.00	27
		2	100	100	0		1800	270	37		170	0.00	17
	Ax	1	254	254	0		Unrestricted	Unrestricted	0		Unrestricted	0.84	120
		2	254	254	0		Unrestricted	Unrestricted	0		Unrestricted	0.84	120
	B	1	361	361	0		1800	570	63		58	0.00	37
		2	91	91	0		1800	150	61		65	0.00	9
	Bx	1	500	500	0		Unrestricted	Unrestricted	0		Unrestricted	0.65	120
		2	500	500	0		Unrestricted	Unrestricted	0		Unrestricted	0.65	120
	C	1	126	126	0		1800	420	30		233	0.00	27
		2	210	210	0		1800	270	78		29	0.00	17
	Cx	1	258	258	0		Unrestricted	Unrestricted	0		Unrestricted	1.13	120
		2	258	258	0		Unrestricted	Unrestricted	0		Unrestricted	1.13	120
	D	1	245	245	0		1800	570	43		133	0.00	37
		2	31	31	0		1800	150	21		384	0.00	9
Dx	1	477	477	0		Unrestricted	Unrestricted	0		Unrestricted	0.93	120	
	2	477	477	0		Unrestricted	Unrestricted	0		Unrestricted	0.93	120	
9	1	425	425	0		Unrestricted	Unrestricted	0		Unrestricted	0.00	120	
10	1	452	452	0		Unrestricted	Unrestricted	0		Unrestricted	0.00	120	
11	1	336	336	0		Unrestricted	Unrestricted	0		Unrestricted	0.00	120	
12	1	276	276	0		Unrestricted	Unrestricted	0		Unrestricted	0.00	120	

Traffic Stream Results: Stops and delays

Time Segment	Arm	Traffic Stream	Mean Cruise Time per Veh (s)	Mean Delay per Veh (s)	Uniform delay (Veh-hr/hr)	Random plus oversat delay (Veh-hr/hr)	Weighted cost of delay (£ per hr)	Mean stops per Veh (%)	Uniform stops (Stops per hr)	Random stops (Stops per hr)	Weighted cost of stops (£ per hr)	
17:00-18:00	A	1	2.40	57.10	3.89	1.27	73.20	103.34	298.88	36.98	4.21	
		2	24.00	49.80	1.28	0.11	19.64	91.40	88.18	3.22	1.15	
	Ax	1	21.95	0.00	0.00	0.00	0.00	0.00	0.00	0.00	0.00	0.00
		2	24.00	40.44	3.51	0.54	57.59	88.21	302.41	16.05	3.99	3.99
	B	1	24.00	40.44	3.51	0.54	57.59	88.21	302.41	16.05	3.99	3.99
		2	2.16	70.98	1.34	0.45	25.48	109.20	86.31	13.06	1.25	1.25
	Bx	1	21.41	0.00	0.00	0.00	0.00	0.00	0.00	0.00	0.00	0.00
		2	24.00	39.76	1.33	0.06	19.76	82.20	101.66	1.92	1.30	1.30
	C	1	24.00	39.76	1.33	0.06	19.76	82.20	101.66	1.92	1.30	1.30
		2	4.80	70.93	2.86	1.27	58.75	112.12	198.92	36.54	2.95	2.95
	Cx	1	23.38	0.00	0.00	0.00	0.00	0.00	0.00	0.00	0.00	0.00
		2	24.00	34.80	2.21	0.16	33.63	79.28	189.41	4.82	2.44	2.44
	D	1	24.00	34.80	2.21	0.16	33.63	79.28	189.41	4.82	2.44	2.44
		2	3.60	54.43	0.44	0.03	6.66	94.09	28.37	0.80	0.37	0.37
Dx	1	21.24	0.00	0.00	0.00	0.00	0.00	0.00	0.00	0.00	0.00	
	2	5.82	0.00	0.00	0.00	0.00	0.00	0.00	0.00	0.00	0.00	
9	1	5.82	0.00	0.00	0.00	0.00	0.00	0.00	0.00	0.00	0.00	
10	1	3.78	0.00	0.00	0.00	0.00	0.00	0.00	0.00	0.00	0.00	
11	1	4.44	0.00	0.00	0.00	0.00	0.00	0.00	0.00	0.00	0.00	
12	1	4.12	0.00	0.00	0.00	0.00	0.00	0.00	0.00	0.00	0.00	

Traffic Stream Results: Queues and blocking

Time Segment	Arm	Traffic Stream	Initial queue (Veh)	Mean max queue (Veh)	Max queue storage (Veh)	Utilised storage (%)	Average storage excess queue (Veh)	Average limit excess queue (Veh)	Excess queue penalty (£ per hr)	Wasted time starvation (s per cycle)	Wasted time blocking back (s per cycle)	Wasted time total (s per cycle)	Estimated blocking	
17:00-18:00	A	1	0.00	11.38	3.48	327.18	2.91	0.00	0.00	0.00	0.00	0.00		
		2	0.00	3.08	34.78	8.86	0.00	0.00	0.00	0.00	0.00	0.00		
	Ax	1	0.00	0.00	31.81	0.00	0.00	0.00	0.00	0.00	35.00	0.00	35.00	
		2	0.00	10.77	34.78	30.96	0.00	0.00	0.00	0.00	0.00	0.00	0.00	
	B	1	0.00	10.77	34.78	30.96	0.00	0.00	0.00	0.00	0.00	0.00	0.00	
		2	0.00	3.36	3.13	107.29	0.01	0.00	0.00	0.00	0.00	0.00	0.00	
	Bx	1	0.00	0.00	31.03	0.00	0.00	0.00	0.00	0.00	20.00	0.00	20.00	
		2	0.00	3.49	34.78	10.05	0.00	0.00	0.00	0.00	0.00	0.00	0.00	
	C	1	0.00	3.49	34.78	10.05	0.00	0.00	0.00	0.00	0.00	0.00	0.00	
		2	0.00	7.98	6.96	114.75	0.08	0.00	0.00	0.00	0.00	0.00	0.00	
	Cx	1	0.00	0.00	33.88	0.00	0.00	0.00	0.00	0.00	60.00	0.00	60.00	
		2	0.00	6.56	34.78	18.86	0.00	0.00	0.00	0.00	0.00	0.00	0.00	
	D	1	0.00	6.56	34.78	18.86	0.00	0.00	0.00	0.00	0.00	0.00	0.00	
		2	0.00	0.98	5.22	18.83	0.00	0.00	0.00	0.00	8.00	0.00	8.00	
Dx	1	0.00	0.00	30.79	0.00	0.00	0.00	0.00	0.00	40.00	0.00	40.00		
	2	0.00	0.00	8.44	0.00	0.00	0.00	0.00	0.00	0.00	88.00	88.00		
9	1	0.00	0.00	8.44	0.00	0.00	0.00	0.00	0.00	0.00	88.00	88.00		
10	1	0.00	0.00	5.47	0.00	0.00	0.00	0.00	0.00	0.00	10.00	10.00		
11	1	0.00	0.00	6.44	0.00	0.00	0.00	0.00	0.00	0.00	18.00	18.00		
12	1	0.00	0.00	5.97	0.00	0.00	0.00	0.00	0.00	0.00	0.00	0.00		

Pedestrian Crossing Results

Pedestrian Crossings: Pedestrian summary

Time Segment	Crossing	Side	Degree of saturation (%)	Calculated Flow Entering (Ped/hr)	Calculated sat flow (Ped/hr)	Actual green (s per cycle)	Mean Delay Per Ped (s)	Mean max queue (Ped)	Weighted cost of delay (£ per hr)	Performance Index (£ per hr)
17:00-18:00	(ALL)	(ALL)	11	50	11000	5	55.58	1.60	10.96	10.96

Pedestrian Crossings: Flows and signals

Time Segment	Crossing	Side	Calculated flow entering (Ped/hr)	Calculated flow out (Ped/hr)	Flow discrepancy (Ped/hr)	Adjusted flow warning	Calculated sat flow (Ped/hr)	Calculated capacity (Ped/hr)	Degree of saturation (%)	DOS Threshold exceeded	Practical reserve capacity (%)	Mean modulus of error	Actual green (s per cycle)
17:00-18:00	(ALL)	(ALL)	50	50	0		11000	458	11		817	0.00	5

Pedestrian Crossings: Stops and delays

Time Segment	Crossing	Side	Mean Cruise Time per Ped (s)	Mean Delay per Ped (s)	Uniform delay (Ped-hr/hr)	Random plus oversat delay (Ped-hr/hr)	Weighted cost of delay (£ per hr)
17:00-18:00	1	1	5.67	55.58	0.77	0.00	10.96
		2	5.67	55.58	0.77	0.00	10.96
	2	1	6.33	55.58	0.77	0.00	10.96
		2	6.33	55.58	0.77	0.00	10.96
	3	1	6.33	55.58	0.77	0.00	10.96
		2	6.33	55.58	0.77	0.00	10.96
	4	1	5.67	55.58	0.77	0.00	10.96
		2	5.67	55.58	0.77	0.00	10.96

Pedestrian Crossings: Queues and blocking

Time Segment	Crossing	Side	Mean max queue (Ped)	Max queue storage (Ped)	Utilised storage (%)	Average storage excess queue (Ped)	Average limit excess queue (Ped)	Excess queue penalty (£ per hr)
17:00-18:00	(ALL)	(ALL)	1.60	10.00	15.97	0.00	0.00	0.00

Network Results

Network Results: Flows and signals

Time Segment	Calculated flow entering (Veh/hr)	Calculated flow out (Veh/hr)	Flow discrepancy (Veh/hr)	Adjusted flow warning	Degree of saturation (%)	DOS Threshold exceeded	Practical reserve capacity (%)	Actual green (s (per cycle))
17:00-18:00	4867	4867	0		78		29	1180

Network Results: Stops and delays

Time Segment	Mean Cruise Time per Veh (s)	Mean Delay per Veh (s)	Uniform delay (Veh-hr/hr)	Random plus oversat delay (Veh-hr/hr)	Weighted cost of delay (£ per hr)	Mean stops per Veh (%)	Uniform stops (Stops per hr)	Random stops (Stops per hr)	Weighted cost of stops (£ per hr)
17:00-18:00	13.09	19.92	23.03	3.90	382.41	28.92	1294.14	113.38	17.65

Network Results: Queues and blocking

Time Segment	Utilised storage (%)	Excess queue penalty (£ per hr)	Wasted time starvation (s (per cycle))	Wasted time blocking back (s (per cycle))	Wasted time total (s (per cycle))
17:00-18:00	327.18	0.00	163.00	116.00	279.00

Final Prediction Table

Traffic Stream Results

Arm	Traffic Stream	Name	Traffic node	SIGNALS		FLOWS		PERFORMANCE				PER PCU			QUEUES
				Controller stream	Phase	Calculated flow entering (Veh/hr)	Calculated sat flow (Veh/hr)	Actual green (s per cycle)	Wasted time total (s per cycle)	Degree of saturation (%)	Practical reserve capacity (%)	JourneyTime (s)	Mean Delay per Veh (s)	Mean stops per Veh (%)	Mean max queue (Veh)
A	1	(untitled)	1	1	D	325 <	1800	27	0.00	77	29	59.50	57.10	103.34	11.38 +
	2		1	1	C	100	1800	17	0.00	37	170	73.80	49.80	91.40	3.08
Ax	1	(untitled)				254	Unrestricted	120	35.00	0	Unrestricted	21.95	0.00	0.00	0.00
B	1	(untitled)	1	1	B	361	1800	37	0.00	63	58	64.44	40.44	88.21	10.77
	2		1	1	A	91 <	1800	9	0.00	61	65	73.14	70.98	109.20	3.36 +
Bx	1	(untitled)				500	Unrestricted	120	20.00	0	Unrestricted	21.41	0.00	0.00	0.00
C	1	(untitled)	1	1	D	126	1800	27	0.00	30	233	63.76	39.76	82.20	3.49
	2		1	1	C	210 <	1800	17	0.00	78	29	75.73	70.93	112.12	7.98 +
Cx	1	(untitled)				258	Unrestricted	120	60.00	0	Unrestricted	23.38	0.00	0.00	0.00
D	1	(untitled)	1	1	B	245	1800	37	0.00	43	133	58.80	34.80	79.28	6.56
	2		1	1	A	31	1800	9	8.00	21	384	58.03	54.43	94.09	0.98
Dx	1	(untitled)				477	Unrestricted	120	40.00	0	Unrestricted	21.24	0.00	0.00	0.00
9	1		1			425	Unrestricted	120	88.00	0	Unrestricted	5.82	0.00	0.00	0.00
10	1		1			452	Unrestricted	120	10.00	0	Unrestricted	3.78	0.00	0.00	0.00
11	1		1			336	Unrestricted	120	18.00	0	Unrestricted	4.44	0.00	0.00	0.00
12	1		1			276	Unrestricted	120	0.00	0	Unrestricted	4.12	0.00	0.00	0.00

Pedestrian Crossing Results

Pedestrian	Side	Name	Traffic node	SIGNALS		FLOWS		PERFORMANCE			PER PED		QUEUES	WEIGHTS	PEN
				Controller stream	Phase	Calculated Flow Entering (Ped/hr)	Calculated sat flow (Ped/hr)	Actual green (s per cycle)	Degree of saturation (%)	Practical reserve capacity (%)	JourneyTime (s)	Mean Delay per Ped (s)	Mean max queue (Ped)	Delay weighting (%)	Co tra pen (£ p
1	1	(untitled)	1	1	E	50	11000	5	11	817	61.25	55.58	1.60	100	0
	2	(untitled)	1	1	E	50	11000	5	11	817	61.25	55.58	1.60	100	0
2	1	(untitled)	1	1	E	50	11000	5	11	817	61.92	55.58	1.60	100	0
	2	(untitled)	1	1	E	50	11000	5	11	817	61.92	55.58	1.60	100	0
3	1	(untitled)	1	1	E	50	11000	5	11	817	61.92	55.58	1.60	100	0
	2	(untitled)	1	1	E	50	11000	5	11	817	61.92	55.58	1.60	100	0
4	1	(untitled)	1	1	E	50	11000	5	11	817	61.25	55.58	1.60	100	0
	2	(untitled)	1	1	E	50	11000	5	11	817	61.25	55.58	1.60	100	0

Network Results

	Distance travelled (PCU-km/hr)	Time spent (PCU-hr/hr)	Mean journey speed (kph)	Uniform delay (Veh-hr/hr)	Random plus oversat delay (Veh-hr/hr)	Weighted cost of delay (£ per hr)	Weighted cost of stops (£ per hr)	Excess queue penalty (£ per hr)	Performance Index (£ per hr)
Normal traffic	511.02	37.79	13.52	16.86	3.90	294.71	17.65	0.00	312.36
Bus	0.00	0.00	0.00	0.00	0.00	0.00	0.00	0.00	0.00
Tram	0.00	0.00	0.00	0.00	0.00	0.00	0.00	0.00	0.00
Pedestrians	3.40	6.84	0.50	6.18	0.00	87.70	0.00	0.00	87.70
TOTAL	514.42	44.63	11.53	23.03	3.90	382.41	17.65	0.00	400.05

- 1 < = adjusted flow warning (upstream links/traffic streams are over-saturated)
- 1 * = Traffic Stream - Normal, Bus or Tram Stop or Delay weighting has been set to a value other than 100%
- 1 ^ = Traffic Stream - Normal, Bus or Tram Stop or Delay Path weighting has been set to a value other than 100%
- 1 + = average link/traffic stream excess queue is greater than 0
- 1 P.I. = PERFORMANCE INDEX

A3 - DO NOTHING 2029 D3 - DO NOTHING 2029*

Summary

Data Errors and Warnings

No errors or warnings

Run Summary

Analysis set used	Run start time	Run finish time	Modelling start time (HH:mm)	Network Cycle Time (s)	Performance Index (£ per hr)	Total network delay (Veh-hr/hr)	Highest DOS (%)	Item with highest DOS	Number of oversaturated items	Percentage of oversaturated items (%)	Item with worst signalised PRC	Item with worst unsignalised PRC	Item with worst over PR
3	19/08/2020 12:06:30	19/08/2020 12:06:31	17:00	120	486.43	32.75	87.14	A/1	0	0	A/1	Dx/1	A/

Analysis Set Details

Name	Description	Demand set	Include in report	Locked
DO NOTHING 2029		D3	✓	

Demand Set Details

Name	Description	Composite	Demand sets	Start time (HH:mm)	Locked
DO NOTHING 2029				17:00	

Arms and Traffic Streams

Arms

Arm	Name	Description	Traffic node
A	(untitled)		1
Ax	(untitled)		
B	(untitled)		1
Bx	(untitled)		
C	(untitled)		1
Cx	(untitled)		
D	(untitled)		1
Dx	(untitled)		
9			1
10			1
11			1
12			1

Traffic Streams

Arm	Traffic Stream	Name	Description	Auto length	Length (m)	Has Saturation Flow	Saturation flow source	Saturation flow (PCU/hr)	Is signal controlled	Is give way	Traffic type	Allow Nearside Turn On Red
A	1	(untitled)			20.00	✓	Sum of lanes	1800	✓		Normal	
	2				200.00	✓	Sum of lanes	1800	✓		Normal	
Ax	1	(untitled)		✓	182.93						Normal	
B	1	(untitled)			200.00	✓	Sum of lanes	1800	✓		Normal	
	2				18.00	✓	Sum of lanes	1800	✓		Normal	
Bx	1	(untitled)		✓	178.44						Normal	
C	1	(untitled)			200.00	✓	Sum of lanes	1800	✓		Normal	
	2				40.00	✓	Sum of lanes	1800	✓		Normal	
Cx	1	(untitled)		✓	194.82						Normal	
D	1	(untitled)			200.00	✓	Sum of lanes	1800	✓		Normal	
	2				30.00	✓	Sum of lanes	1800	✓		Normal	
Dx	1	(untitled)		✓	177.04						Normal	
9	1			✓	48.53						Normal	
10	1			✓	31.46						Normal	
11	1			✓	37.01						Normal	
12	1			✓	34.36						Normal	

Lanes

Arm	Traffic Stream	Lane	Name	Description	Use RR67	Saturation flow (PCU/hr)
A	1	1	(untitled)			1800
	2	1	(untitled)			1800
Ax	1	1	(untitled)			
B	1	1	(untitled)			1800
	2	1	(untitled)			1800
Bx	1	1	(untitled)			
C	1	1	(untitled)			1800
	2	1	(untitled)			1800
Cx	1	1	(untitled)			
D	1	1	(untitled)			1800
	2	1	(untitled)			1800
Dx	1	1	(untitled)			
9	1	1	(untitled)			
10	1	1	(untitled)			
11	1	1	(untitled)			
12	1	1	(untitled)			

Modelling

Arm	Traffic Stream	Traffic model	Stop weighting multiplier (%)	Delay weighting multiplier (%)	Assignment Cost Weighting (%)	Exclude from results calculation	Max queue storage (PCU)	Has queue limit	Has degree of saturation limit
(ALL)	(ALL)	NetworkDefault	100	100	100		0.00		

Modelling - Advanced

Arm	Traffic Stream	Initial queue (PCU)	Type of Vehicle-in-Service	Vehicle-in-Service	Type of random parameter	Random parameter	Auto cycle time	Cycle time
(ALL)	(ALL)	0.00	NetworkDefault	Not-Included	NetworkDefault	0.50	✓	120

Normal traffic - Modelling

Arm	Traffic Stream	Stop weighting (%)	Delay weighting (%)
(ALL)	(ALL)	100	100

Normal traffic - Advanced

Arm	Traffic Stream	Dispersion type for Normal Traffic
(ALL)	(ALL)	NetworkDefault

Flows

Arm	Traffic Stream	Total Flow (Veh/hr)	Normal Flow (Veh/hr)
A	1	366	366
	2	109	109
Ax	1	295	295
B	1	393	393
	2	99	99
Bx	1	580	580
C	1	157	157
	2	264	264
Cx	1	294	294
D	1	267	267
	2	35	35
Dx	1	521	521
9	1	475	475
10	1	492	492
11	1	421	421
12	1	302	302

Signals

Arm	Traffic Stream	Controller stream	Phase	Second phase enabled
A	1	1	D	
	2	1	C	
B	1	1	B	
	2	1	A	
C	1	1	D	
	2	1	C	
D	1	1	B	
	2	1	A	

Pedestrian Crossings

Pedestrian Crossings

Crossing	Name	Description	Traffic node	Allow walk on red	Crossing type	Length (m)	Cruise time (seconds)	Cruise speed (kph)
1	(untitled)		1		Farside	7.00	4.67	5.40
2	(untitled)		1		Farside	8.00	5.33	5.40
3	(untitled)		1		Farside	8.00	5.33	5.40
4	(untitled)		1		Farside	7.00	4.67	5.40

Pedestrian Crossings - Signals

Crossing	Controller stream	Phase	Second phase enabled
(ALL)	1	E	

Pedestrian Crossings - Sides

Crossing	Side	Saturation flow (Ped/hr)
(ALL)	(ALL)	11000

Pedestrian Crossings - Modelling

Crossing	Side	Delay weighting (%)	Assignment Cost Weighting (%)	Exclude from results calculation	Max queue storage (Ped)	Has queue limit	Has degree of saturation limit
(ALL)	(ALL)	100	100		0.00		

Local OD Matrix - Local Matrix: 1

Local Matrix Options

OD Matrix	Name	Use for point to point table	Auto calculate	Allocation mode	Allow paths past exit locations	Allow looped paths on arms	Allow looped paths on traffic nodes	Copy flows	Matrix to copy flows from	Limit paths by length	Path length limit multiplier	Limit paths by number	Path number limit
1	(untitled)	✓	✓	Path Equalisation	✓		✓			✓	1.25		

Normal Input Flows (Veh/hr)

	To							
	1	2	3	4	5	6	7	8
From 1	0	21	136	264	0	0	0	0
From 2	35	0	60	207	0	0	0	0
From 3	257	109	0	109	0	0	0	0
From 4	2	391	99	0	0	0	0	0
From 5	0	0	0	0	0	0	0	0
From 6	0	0	0	0	0	0	0	0
From 7	0	0	0	0	0	0	0	0
From 8	0	0	0	0	0	0	0	0

Bus Input Flows not shown as they are blank.

Tram Input Flows not shown as they are blank.

Pedestrian Input Flows (Veh/hr)

	To							
	1	2	3	4	5	6	7	8
From 1	0	0	0	0	0	0	0	0
From 2	0	0	0	0	0	0	0	0
From 3	0	0	0	0	0	0	0	0
From 4	0	0	0	0	0	0	0	0
From 5	0	0	0	0	0	50	50	0
From 6	0	0	0	0	50	0	0	50
From 7	0	0	0	0	50	0	0	50
From 8	0	0	0	0	0	50	50	0

Locations

OD Matrix	Location	Name	Entries	Exits	Colour
1	1	(untitled)	11/1	Cx/1	#0000FF
	2	(untitled)	12/1	Dx/1	#FF0000
	3	(untitled)	9/1	Ax/1	#00FF00
	4	(untitled)	10/1	Bx/1	#FFFF00
	5	(untitled)	3:2E, 1:1E	3:2X, 1:1X	#FF00FF
	6	(untitled)	2:1E, 1:2E	2:1X, 1:2X	#008000
	7	(untitled)	4:2E, 3:1E	4:2X, 3:1X	#FFA500
	8	(untitled)	4:1E, 2:2E	4:1X, 2:2X	#00FFFF

Normal Paths and Flows

OD Matrix	Path	Description	From location	To location	Path items	Allocation type	Normal Calculated Flow (Veh/hr)
1	9		4	3	10/1, B/2, Ax/1	Normal	99
	10		3	4	9/1, A/1, Bx/1	Normal	109
	11		1	3	11/1, C/1, Ax/1	Normal	136
	12		1	4	11/1, C/2, Bx/1	Normal	264
	13		3	1	9/1, A/1, Cx/1	Normal	257
	14		4	1	10/1, B/1, Cx/1	Normal	2
	15		2	3	12/1, D/1, Ax/1	Normal	60
	16		2	4	12/1, D/1, Bx/1	Normal	207
	19		3	2	9/1, A/2, Dx/1	Normal	109
	20		4	2	10/1, B/1, Dx/1	Normal	391
	43		2	1	12/1, D/2, Cx/1	Normal	35
	44		1	2	11/1, C/1, Dx/1	Normal	21

Pedestrian Paths and Flows

OD Matrix	Path	Description	From location	To location	Path items	Allocation type	Pedestrian calculated flow (Ped/hr)
1	17		8	7	4:1E, 4:2X	Normal	50
	18		8	6	2:2E, 2:1X	Normal	50
	22		5	7	3:2E, 3:1X	Normal	50
	23		5	6	1:1E, 1:2X	Normal	50
	34		6	8	2:1E, 2:2X	Normal	50
	35		6	5	1:2E, 1:1X	Normal	50
	41		7	8	4:2E, 4:1X	Normal	50
	42		7	5	3:1E, 3:2X	Normal	50

Signal Timings

Network Default: 120s cycle time; 120 steps

Controller Stream 1

Controller Stream	Name	Description	Use sequence	Cycle time source	Cycle time (s)
1	(untitled)		1	NetworkDefault	120

Controller Stream 1 - Properties

Controller Stream	Manufacturer name	Type	Model number	(Telephone) Line Number	Site number	Grid reference	Gaining delay type
1	Unspecified						Relative

Controller Stream 1 - Optimisation

Controller Stream	Allow offset optimisation	Allow green split optimisation	Optimisation level	Auto redistribute	Enable stage constraint
1	✓	✓	Offsets And Green Splits	✓	

Phases

Controller Stream	Phase	Name	Minimum green (s)	Maximum green (s)	Relative start displacement (s)	Relative end displacement (s)	Type	Blackout Time (s)
1	A	(untitled)	7	70	0	0	Traffic	
	B	(untitled)	7	70	0	0	Traffic	
	C	(untitled)	7	70	0	0	Traffic	
	D	(untitled)	7	70	0	0	Traffic	
	E	(untitled)	5	5	0	0	Pedestrian	0

Library Stages

Controller Stream	Library Stage	Phases in stage	User stage minimum (s)
1	1	A	1
	2	B	1
	3	C	1
	4	D	1
	5	E	1

Stage Sequences

Controller Stream	Sequence	Name	Multiple cycling	Stage IDs	Stage ends
1	1	(untitled)	Single	1, 2, 3, 4, 5	0, 39, 64, 96, 106

Intergreen Matrix for Controller Stream 1

		To				
		A	B	C	D	E
From	A		5	5	5	5
	B	5		5	5	5
	C	5	5		5	5
	D	5	5	5		5
	E	5	5	5	5	

Banned Stage transitions for Controller Stream 1

		To				
		1	2	3	4	5
From	1					
	2					
	3					
	4					
	5					

Interstage Matrix for Controller Stream 1

		To				
		1	2	3	4	5
From	1	0	5	5	5	5
	2	5	0	5	5	5
	3	5	5	0	5	5
	4	5	5	5	0	5
	5	5	5	5	5	0

Resultant Stages

Controller Stream	Resultant Stage	Is base stage	Library Stage ID	Phases in this stage	Stage start (s)	Stage end (s)	Stage duration (s)	User stage minimum (s)	Stage minimum (s)
1	1	✓	1	A	111	0	9	1	7
	2	✓	2	B	5	39	34	1	7
	3	✓	3	C	44	64	20	1	7
	4	✓	4	D	69	96	27	1	7
	5	✓	5	E	101	106	5	1	5

Resultant Phase Green Periods

Controller Stream	Phase	Green period	Is base green period	Start time (s)	End time (s)	Duration (s)
1	A	1	✓	111	0	9
	B	1	✓	5	39	34
	C	1	✓	44	64	20
	D	1	✓	69	96	27
	E	1	✓	101	106	5

Traffic Stream Green Times

Arm	Traffic Stream	Traffic Node	Controller Stream	Phase	Green Period 1		
					Start	End	Duration
A	1	1	1	D	69	96	27
A	2	1	1	C	44	64	20
B	1	1	1	B	5	39	34
B	2	1	1	A	111	0	9
C	1	1	1	D	69	96	27
C	2	1	1	C	44	64	20
D	1	1	1	B	5	39	34
D	2	1	1	A	111	0	9

Phase Timings Diagram for Controller Stream 1

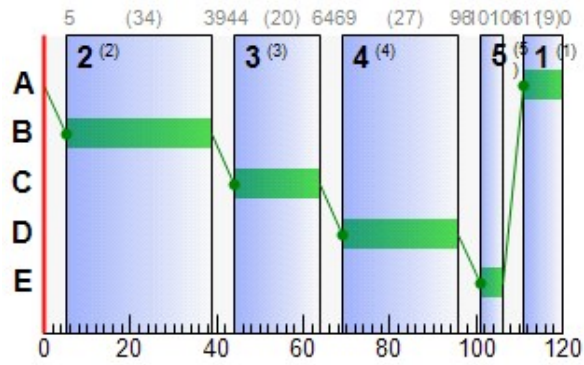

Stage Sequence Diagram for Controller Stream 1

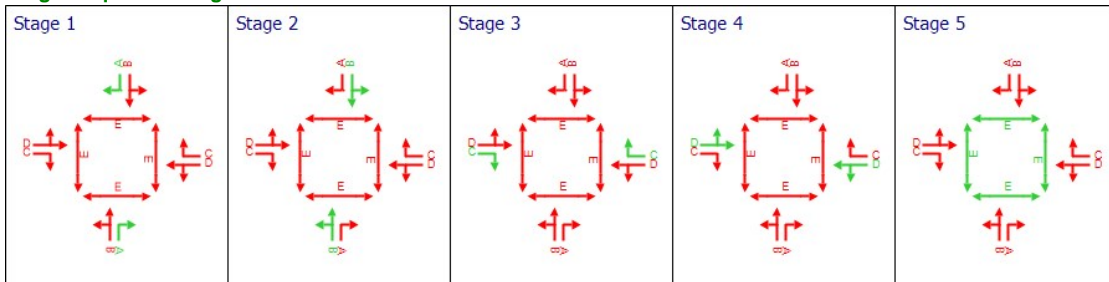

Resultant penalties

Time Segment	Controller stream	Phase min max penalty (£ per hr)	Intergreen broken penalty (£ per hr)	Stage constraint broken penalty (£ per hr)	Cost of controller stream penalties (£ per hr)
17:00-18:00	1	0.00	0.00	0.00	0.00

Traffic Stream Results

Traffic Stream Results: Vehicle summary

Time Segment	Arm	Traffic Stream	Degree of saturation (%)	Practical reserve capacity (%)	Calculated flow entering (Veh/hr)	Calculated sat flow (Veh/hr)	Actual green (s per cycle)	Mean Delay per Veh (s)	Mean max queue (Veh)	Utilised storage (%)	Weighted cost of delay (£ per hr)	Weighted cost of stops (£ per hr)	Performance Index (£ per hr)	
17:00-18:00	A	1	87	15	366	1800	27	70.00	14.31	411.34	101.06	5.27	106.33	
		2	35	189	109	1800	20	46.50	3.27	9.40	19.99	1.22	21.21	
	Ax	1	0	Unrestricted	295	Unrestricted	120	0.00	0.00	0.00	0.00	0.00	0.00	0.00
		2	0	Unrestricted	295	Unrestricted	120	0.00	0.00	0.00	0.00	0.00	0.00	0.00
	B	1	75	34	393	1800	34	48.45	12.87	37.01	75.10	4.78	79.88	
		2	66	52	99	1800	9	75.56	3.80	121.40	29.51	1.41	30.91	
	Bx	1	0	Unrestricted	580	Unrestricted	120	0.00	0.00	0.00	0.00	0.00	0.00	0.00
		2	0	Unrestricted	580	Unrestricted	120	0.00	0.00	0.00	0.00	0.00	0.00	0.00
	C	1	37	168	157	1800	27	41.19	4.47	12.86	25.51	1.66	27.17	
		2	84	19	264	1800	20	74.52	10.39	149.34	77.60	3.84	81.44	
	Cx	1	0	Unrestricted	294	Unrestricted	120	0.00	0.00	0.00	0.00	0.00	0.00	0.00
		2	0	Unrestricted	294	Unrestricted	120	0.00	0.00	0.00	0.00	0.00	0.00	0.00
	D	1	51	97	267	1800	34	38.88	7.60	21.86	40.95	2.82	43.77	
		2	23	329	35	1800	9	55.08	1.12	21.55	7.60	0.42	8.02	
Dx	1	0	Unrestricted	521	Unrestricted	120	0.00	0.00	0.00	0.00	0.00	0.00	0.00	
	2	0	Unrestricted	521	Unrestricted	120	0.00	0.00	0.00	0.00	0.00	0.00	0.00	
9	1	0	Unrestricted	475	Unrestricted	120	0.00	0.00	0.00	0.00	0.00	0.00	0.00	
10	1	0	Unrestricted	492	Unrestricted	120	0.00	0.00	0.00	0.00	0.00	0.00	0.00	
11	1	0	Unrestricted	421	Unrestricted	120	0.00	0.00	0.00	0.00	0.00	0.00	0.00	
12	1	0	Unrestricted	302	Unrestricted	120	0.00	0.00	0.00	0.00	0.00	0.00	0.00	

Traffic Stream Results: Flows and signals

Time Segment	Arm	Traffic Stream	Calculated flow entering (Veh/hr)	Calculated flow out (Veh/hr)	Flow discrepancy (Veh/hr)	Adjusted flow warning	Calculated sat flow (Veh/hr)	Calculated capacity (Veh/hr)	Degree of saturation (%)	DOS Threshold exceeded	Practical reserve capacity (%)	Mean modulus of error	Actual green (s per cycle)
17:00-18:00	A	1	366	366	0		1800	420	87		15	0.00	27
		2	109	109	0		1800	315	35		189	0.00	20
	Ax	1	295	295	0		Unrestricted	Unrestricted	0		Unrestricted	0.82	120
		2	295	295	0		Unrestricted	Unrestricted	0		Unrestricted	0.82	120
	B	1	393	393	0		1800	525	75		34	0.00	34
		2	99	99	0		1800	150	66		52	0.00	9
	Bx	1	580	580	0		Unrestricted	Unrestricted	0		Unrestricted	0.62	120
		2	580	580	0		Unrestricted	Unrestricted	0		Unrestricted	0.62	120
	C	1	157	157	0		1800	420	37		168	0.00	27
		2	264	264	0		1800	315	84		19	0.00	20
	Cx	1	294	294	0		Unrestricted	Unrestricted	0		Unrestricted	1.11	120
		2	294	294	0		Unrestricted	Unrestricted	0		Unrestricted	1.11	120
	D	1	267	267	0		1800	525	51		97	0.00	34
		2	35	35	0		1800	150	23		329	0.00	9
Dx	1	521	521	0		Unrestricted	Unrestricted	0		Unrestricted	0.95	120	
	2	521	521	0		Unrestricted	Unrestricted	0		Unrestricted	0.95	120	
9	1	475	475	0		Unrestricted	Unrestricted	0		Unrestricted	0.00	120	
10	1	492	492	0		Unrestricted	Unrestricted	0		Unrestricted	0.00	120	
11	1	421	421	0		Unrestricted	Unrestricted	0		Unrestricted	0.00	120	
12	1	302	302	0		Unrestricted	Unrestricted	0		Unrestricted	0.00	120	

Traffic Stream Results: Stops and delays

Time Segment	Arm	Traffic Stream	Mean Cruise Time per Veh (s)	Mean Delay per Veh (s)	Uniform delay (Veh-hr/hr)	Random plus oversat delay (Veh-hr/hr)	Weighted cost of delay (£ per hr)	Mean stops per Veh (%)	Uniform stops (Stops per hr)	Random stops (Stops per hr)	Weighted cost of stops (£ per hr)	
17:00-18:00	A	1	2.40	70.00	4.50	2.62	101.06	114.89	346.07	74.42	5.27	
		2	24.00	46.50	1.32	0.09	19.99	88.97	94.26	2.72	1.22	
	Ax	1	21.95	0.00	0.00	0.00	0.00	0.00	0.00	0.00	0.00	0.00
		1	24.00	48.45	4.20	1.08	75.10	96.91	348.99	31.86	4.78	
	B	2	2.16	75.56	1.47	0.61	29.51	113.33	94.71	17.49	1.41	
		1	21.41	0.00	0.00	0.00	0.00	0.00	0.00	0.00	0.00	0.00
	Cx	1	24.00	41.19	1.69	0.11	25.51	84.46	129.28	3.32	1.66	
		2	4.80	74.52	3.51	1.96	77.60	115.89	250.41	55.52	3.84	
	D	1	23.38	0.00	0.00	0.00	0.00	0.00	0.00	0.00	0.00	0.00
		1	24.00	38.88	2.62	0.26	40.95	84.36	217.44	7.79	2.82	
	Dx	2	3.60	55.08	0.50	0.04	7.60	95.35	32.32	1.05	0.42	
		1	21.24	0.00	0.00	0.00	0.00	0.00	0.00	0.00	0.00	0.00
	9	1	5.82	0.00	0.00	0.00	0.00	0.00	0.00	0.00	0.00	0.00
	10	1	3.78	0.00	0.00	0.00	0.00	0.00	0.00	0.00	0.00	0.00
11	1	4.44	0.00	0.00	0.00	0.00	0.00	0.00	0.00	0.00	0.00	
12	1	4.12	0.00	0.00	0.00	0.00	0.00	0.00	0.00	0.00	0.00	

Traffic Stream Results: Queues and blocking

Time Segment	Arm	Traffic Stream	Initial queue (Veh)	Mean max queue (Veh)	Max queue storage (Veh)	Utilised storage (%)	Average storage excess queue (Veh)	Average limit excess queue (Veh)	Excess queue penalty (£ per hr)	Wasted time starvation (s per cycle)	Wasted time blocking back (s per cycle)	Wasted time total (s per cycle)	Estimated blocking	
17:00-18:00	A	1	0.00	14.31	3.48	411.34	4.85	0.00	0.00	0.00	0.00	0.00		
		2	0.00	3.27	34.78	9.40	0.00	0.00	0.00	0.00	0.00	0.00	0.00	
	Ax	1	0.00	0.00	31.81	0.00	0.00	0.00	0.00	0.00	35.00	0.00	35.00	
		1	0.00	12.87	34.78	37.01	0.00	0.00	0.00	0.00	0.00	0.00	0.00	
	B	2	0.00	3.80	3.13	121.40	0.07	0.00	0.00	0.00	0.00	0.00	0.00	
		1	0.00	0.00	31.03	0.00	0.00	0.00	0.00	0.00	18.00	0.00	18.00	
	Cx	1	0.00	4.47	34.78	12.86	0.00	0.00	0.00	0.00	0.00	0.00	0.00	
		2	0.00	10.39	6.96	149.34	0.68	0.00	0.00	0.00	0.00	0.00	0.00	
	D	1	0.00	0.00	33.88	0.00	0.00	0.00	0.00	0.00	59.00	0.00	59.00	
		1	0.00	7.60	34.78	21.86	0.00	0.00	0.00	0.00	0.00	0.00	0.00	
	Dx	2	0.00	1.12	5.22	21.55	0.00	0.00	0.00	0.00	7.00	0.00	7.00	
		1	0.00	0.00	30.79	0.00	0.00	0.00	0.00	0.00	38.00	0.00	38.00	
	9	1	0.00	0.00	8.44	0.00	0.00	0.00	0.00	0.00	107.00	0.00	107.00	
	10	1	0.00	0.00	5.47	0.00	0.00	0.00	0.00	0.00	25.00	0.00	25.00	
11	1	0.00	0.00	6.44	0.00	0.00	0.00	0.00	0.00	47.00	0.00	47.00		
12	1	0.00	0.00	5.97	0.00	0.00	0.00	0.00	0.00	0.00	0.00	0.00		

Pedestrian Crossing Results

Pedestrian Crossings: Pedestrian summary

Time Segment	Crossing	Side	Degree of saturation (%)	Calculated Flow Entering (Ped/hr)	Calculated sat flow (Ped/hr)	Actual green (s per cycle)	Mean Delay Per Ped (s)	Mean max queue (Ped)	Weighted cost of delay (£ per hr)	Performance Index (£ per hr)
17:00-18:00	(ALL)	(ALL)	11	50	11000	5	55.58	1.60	10.96	10.96

Pedestrian Crossings: Flows and signals

Time Segment	Crossing	Side	Calculated flow entering (Ped/hr)	Calculated flow out (Ped/hr)	Flow discrepancy (Ped/hr)	Adjusted flow warning	Calculated sat flow (Ped/hr)	Calculated capacity (Ped/hr)	Degree of saturation (%)	DOS Threshold exceeded	Practical reserve capacity (%)	Mean modulus of error	Actual green (s per cycle)
17:00-18:00	(ALL)	(ALL)	50	50	0		11000	458	11		817	0.00	5

Pedestrian Crossings: Stops and delays

Time Segment	Crossing	Side	Mean Cruise Time per Ped (s)	Mean Delay per Ped (s)	Uniform delay (Ped-hr/hr)	Random plus oversat delay (Ped-hr/hr)	Weighted cost of delay (£ per hr)
17:00-18:00	1	1	5.67	55.58	0.77	0.00	10.96
		2	5.67	55.58	0.77	0.00	10.96
	2	1	6.33	55.58	0.77	0.00	10.96
		2	6.33	55.58	0.77	0.00	10.96
	3	1	6.33	55.58	0.77	0.00	10.96
		2	6.33	55.58	0.77	0.00	10.96
	4	1	5.67	55.58	0.77	0.00	10.96
		2	5.67	55.58	0.77	0.00	10.96

Pedestrian Crossings: Queues and blocking

Time Segment	Crossing	Side	Mean max queue (Ped)	Max queue storage (Ped)	Utilised storage (%)	Average storage excess queue (Ped)	Average limit excess queue (Ped)	Excess queue penalty (£ per hr)
17:00-18:00	(ALL)	(ALL)	1.60	10.00	15.97	0.00	0.00	0.00

Network Results

Network Results: Flows and signals

Time Segment	Calculated flow entering (Veh/hr)	Calculated flow out (Veh/hr)	Flow discrepancy (Veh/hr)	Adjusted flow warning	Degree of saturation (%)	DOS Threshold exceeded	Practical reserve capacity (%)	Actual green (s (per cycle))
17:00-18:00	5470	5470	0		87		15	1180

Network Results: Stops and delays

Time Segment	Mean Cruise Time per Veh (s)	Mean Delay per Veh (s)	Uniform delay (Veh-hr/hr)	Random plus oversat delay (Veh-hr/hr)	Weighted cost of delay (£ per hr)	Mean stops per Veh (%)	Uniform stops (Stops per hr)	Random stops (Stops per hr)	Weighted cost of stops (£ per hr)
17:00-18:00	13.10	21.55	25.98	6.77	465.02	31.22	1513.48	194.17	21.41

Network Results: Queues and blocking

Time Segment	Utilised storage (%)	Excess queue penalty (£ per hr)	Wasted time starvation (s (per cycle))	Wasted time blocking back (s (per cycle))	Wasted time total (s (per cycle))
17:00-18:00	411.34	0.00	157.00	179.00	336.00

Final Prediction Table

Traffic Stream Results

Arm	Traffic Stream	Name	Traffic node	SIGNALS		FLOWS		PERFORMANCE				PER PCU			QUEUES
				Controller stream	Phase	Calculated flow entering (Veh/hr)	Calculated sat flow (Veh/hr)	Actual green (s per cycle)	Wasted time total (s per cycle)	Degree of saturation (%)	Practical reserve capacity (%)	JourneyTime (s)	Mean Delay per Veh (s)	Mean stops per Veh (%)	Mean max queue (Veh)
A	1	(untitled)	1	1	D	366 <	1800	27	0.00	87	15	72.40	70.00	114.89	14.31 +
	2		1	1	C	109	1800	20	0.00	35	189	70.50	46.50	88.97	3.27
Ax	1	(untitled)				295	Unrestricted	120	35.00	0	Unrestricted	21.95	0.00	0.00	0.00
B	1	(untitled)	1	1	B	393	1800	34	0.00	75	34	72.45	48.45	96.91	12.87
	2		1	1	A	99 <	1800	9	0.00	66	52	77.72	75.56	113.33	3.80 +
Bx	1	(untitled)				580	Unrestricted	120	18.00	0	Unrestricted	21.41	0.00	0.00	0.00
C	1	(untitled)	1	1	D	157	1800	27	0.00	37	168	65.19	41.19	84.46	4.47
	2		1	1	C	264 <	1800	20	0.00	84	19	79.32	74.52	115.89	10.39 +
Cx	1	(untitled)				294	Unrestricted	120	59.00	0	Unrestricted	23.38	0.00	0.00	0.00
D	1	(untitled)	1	1	B	267	1800	34	0.00	51	97	62.88	38.88	84.36	7.60
	2		1	1	A	35	1800	9	7.00	23	329	58.68	55.08	95.35	1.12
Dx	1	(untitled)				521	Unrestricted	120	38.00	0	Unrestricted	21.24	0.00	0.00	0.00
9	1		1			475	Unrestricted	120	107.00	0	Unrestricted	5.82	0.00	0.00	0.00
10	1		1			492	Unrestricted	120	25.00	0	Unrestricted	3.78	0.00	0.00	0.00
11	1		1			421	Unrestricted	120	47.00	0	Unrestricted	4.44	0.00	0.00	0.00
12	1		1			302	Unrestricted	120	0.00	0	Unrestricted	4.12	0.00	0.00	0.00

Pedestrian Crossing Results

Pedestrian	Side	Name	Traffic node	SIGNALS		FLOWS		PERFORMANCE			PER PED		QUEUES	WEIGHTS	PEN
				Controller stream	Phase	Calculated Flow Entering (Ped/hr)	Calculated sat flow (Ped/hr)	Actual green (s per cycle)	Degree of saturation (%)	Practical reserve capacity (%)	JourneyTime (s)	Mean Delay per Ped (s)	Mean max queue (Ped)	Delay weighting (%)	Co tra pen (£ p
1	1	(untitled)	1	1	E	50	11000	5	11	817	61.25	55.58	1.60	100	0
	2	(untitled)	1	1	E	50	11000	5	11	817	61.25	55.58	1.60	100	0
2	1	(untitled)	1	1	E	50	11000	5	11	817	61.92	55.58	1.60	100	0
	2	(untitled)	1	1	E	50	11000	5	11	817	61.92	55.58	1.60	100	0
3	1	(untitled)	1	1	E	50	11000	5	11	817	61.92	55.58	1.60	100	0
	2	(untitled)	1	1	E	50	11000	5	11	817	61.92	55.58	1.60	100	0
4	1	(untitled)	1	1	E	50	11000	5	11	817	61.25	55.58	1.60	100	0
	2	(untitled)	1	1	E	50	11000	5	11	817	61.25	55.58	1.60	100	0

Network Results

	Distance travelled (PCU-km/hr)	Time spent (PCU-hr/hr)	Mean journey speed (kph)	Uniform delay (Veh-hr/hr)	Random plus oversat delay (Veh-hr/hr)	Weighted cost of delay (£ per hr)	Weighted cost of stops (£ per hr)	Excess queue penalty (£ per hr)	Performance Index (£ per hr)
Normal traffic	577.37	45.82	12.60	19.81	6.77	377.32	21.41	0.00	398.73
Bus	0.00	0.00	0.00	0.00	0.00	0.00	0.00	0.00	0.00
Tram	0.00	0.00	0.00	0.00	0.00	0.00	0.00	0.00	0.00
Pedestrians	3.40	6.84	0.50	6.18	0.00	87.70	0.00	0.00	87.70
TOTAL	580.77	52.66	11.03	25.98	6.77	465.02	21.41	0.00	486.43

- 1 < = adjusted flow warning (upstream links/traffic streams are over-saturated)
- 1 * = Traffic Stream - Normal, Bus or Tram Stop or Delay weighting has been set to a value other than 100%
- 1 ^ = Traffic Stream - Normal, Bus or Tram Stop or Delay Path weighting has been set to a value other than 100%
- 1 + = average link/traffic stream excess queue is greater than 0
- 1 P.I. = PERFORMANCE INDEX

A4 - DO NOTHING 2039

D4 - DO NOTHING 2039*

Summary

Data Errors and Warnings

No errors or warnings

Run Summary

Analysis set used	Run start time	Run finish time	Modelling start time (HH:mm)	Network Cycle Time (s)	Performance Index (£ per hr)	Total network delay (Veh-hr/hr)	Highest DOS (%)	Item with highest DOS	Number of oversaturated items	Percentage of oversaturated items (%)	Item with worst signalised PRC	Item with worst unsignalised PRC	Item with worst over PR
4	19/08/2020 12:06:31	19/08/2020 12:06:32	17:00	120	570.03	38.42	93.33	A/1	0	0	A/1	Dx/1	A/

Analysis Set Details

Name	Description	Demand set	Include in report	Locked
DO NOTHING 2039		D4	✓	

Demand Set Details

Name	Description	Composite	Demand sets	Start time (HH:mm)	Locked
DO NOTHING 2039				17:00	

Arms and Traffic Streams

Arms

Arm	Name	Description	Traffic node
A	(untitled)		1
Ax	(untitled)		
B	(untitled)		1
Bx	(untitled)		
C	(untitled)		1
Cx	(untitled)		
D	(untitled)		1
Dx	(untitled)		
9			1
10			1
11			1
12			1

Traffic Streams

Arm	Traffic Stream	Name	Description	Auto length	Length (m)	Has Saturation Flow	Saturation flow source	Saturation flow (PCU/hr)	Is signal controlled	Is give way	Traffic type	Allow Nearside Turn On Red
A	1	(untitled)			20.00	✓	Sum of lanes	1800	✓		Normal	
	2				200.00	✓	Sum of lanes	1800	✓		Normal	
Ax	1	(untitled)		✓	182.93						Normal	
B	1	(untitled)			200.00	✓	Sum of lanes	1800	✓		Normal	
	2				18.00	✓	Sum of lanes	1800	✓		Normal	
Bx	1	(untitled)		✓	178.44						Normal	
C	1	(untitled)			200.00	✓	Sum of lanes	1800	✓		Normal	
	2				40.00	✓	Sum of lanes	1800	✓		Normal	
Cx	1	(untitled)		✓	194.82						Normal	
D	1	(untitled)			200.00	✓	Sum of lanes	1800	✓		Normal	
	2				30.00	✓	Sum of lanes	1800	✓		Normal	
Dx	1	(untitled)		✓	177.04						Normal	
9	1			✓	48.53						Normal	
10	1			✓	31.46						Normal	
11	1			✓	37.01						Normal	
12	1			✓	34.36						Normal	

Lanes

Arm	Traffic Stream	Lane	Name	Description	Use RR67	Saturation flow (PCU/hr)
A	1	1	(untitled)			1800
	2	1	(untitled)			1800
Ax	1	1	(untitled)			
B	1	1	(untitled)			1800
	2	1	(untitled)			1800
Bx	1	1	(untitled)			
C	1	1	(untitled)			1800
	2	1	(untitled)			1800
Cx	1	1	(untitled)			
D	1	1	(untitled)			1800
	2	1	(untitled)			1800
Dx	1	1	(untitled)			
9	1	1	(untitled)			
10	1	1	(untitled)			
11	1	1	(untitled)			
12	1	1	(untitled)			

Modelling

Arm	Traffic Stream	Traffic model	Stop weighting multiplier (%)	Delay weighting multiplier (%)	Assignment Cost Weighting (%)	Exclude from results calculation	Max queue storage (PCU)	Has queue limit	Has degree of saturation limit
(ALL)	(ALL)	NetworkDefault	100	100	100		0.00		

Modelling - Advanced

Arm	Traffic Stream	Initial queue (PCU)	Type of Vehicle-in-Service	Vehicle-in-Service	Type of random parameter	Random parameter	Auto cycle time	Cycle time
(ALL)	(ALL)	0.00	NetworkDefault	Not-Included	NetworkDefault	0.50	✓	120

Normal traffic - Modelling

Arm	Traffic Stream	Stop weighting (%)	Delay weighting (%)
(ALL)	(ALL)	100	100

Normal traffic - Advanced

Arm	Traffic Stream	Dispersion type for Normal Traffic
(ALL)	(ALL)	NetworkDefault

Flows

Arm	Traffic Stream	Total Flow (Veh/hr)	Normal Flow (Veh/hr)
A	1	392	392
	2	117	117
Ax	1	316	316
B	1	424	424
	2	107	107
Bx	1	620	620
C	1	168	168
	2	281	281
Cx	1	315	315
D	1	286	286
	2	37	37
Dx	1	561	561
9	1	509	509
10	1	531	531
11	1	449	449
12	1	323	323

Signals

Arm	Traffic Stream	Controller stream	Phase	Second phase enabled
A	1	1	D	
	2	1	C	
B	1	1	B	
	2	1	A	
C	1	1	D	
	2	1	C	
D	1	1	B	
	2	1	A	

Pedestrian Crossings

Pedestrian Crossings

Crossing	Name	Description	Traffic node	Allow walk on red	Crossing type	Length (m)	Cruise time (seconds)	Cruise speed (kph)
1	(untitled)		1		Farside	7.00	4.67	5.40
2	(untitled)		1		Farside	8.00	5.33	5.40
3	(untitled)		1		Farside	8.00	5.33	5.40
4	(untitled)		1		Farside	7.00	4.67	5.40

Pedestrian Crossings - Signals

Crossing	Controller stream	Phase	Second phase enabled
(ALL)	1	E	

Pedestrian Crossings - Sides

Crossing	Side	Saturation flow (Ped/hr)
(ALL)	(ALL)	11000

Pedestrian Crossings - Modelling

Crossing	Side	Delay weighting (%)	Assignment Cost Weighting (%)	Exclude from results calculation	Max queue storage (Ped)	Has queue limit	Has degree of saturation limit
(ALL)	(ALL)	100	100		0.00		

Local OD Matrix - Local Matrix: 1

Local Matrix Options

OD Matrix	Name	Use for point to point table	Auto calculate	Allocation mode	Allow paths past exit locations	Allow looped paths on arms	Allow looped paths on traffic nodes	Copy flows	Matrix to copy flows from	Limit paths by length	Path length limit multiplier	Limit paths by number	Path number limit
1	(untitled)	✓	✓	Path Equalisation	✓		✓			✓	1.25		

Normal Input Flows (Veh/hr)

	To							
	1	2	3	4	5	6	7	8
From 1	0	23	145	281	0	0	0	0
From 2	37	0	64	222	0	0	0	0
From 3	275	117	0	117	0	0	0	0
From 4	3	421	107	0	0	0	0	0
From 5	0	0	0	0	0	0	0	0
From 6	0	0	0	0	0	0	0	0
From 7	0	0	0	0	0	0	0	0
From 8	0	0	0	0	0	0	0	0

Bus Input Flows not shown as they are blank.

Pedestrian Input Flows (Veh/hr)

	To							
	1	2	3	4	5	6	7	8
From 1	0	0	0	0	0	0	0	0
From 2	0	0	0	0	0	0	0	0
From 3	0	0	0	0	0	0	0	0
From 4	0	0	0	0	0	0	0	0
From 5	0	0	0	0	0	50	50	0
From 6	0	0	0	0	50	0	0	50
From 7	0	0	0	0	50	0	0	50
From 8	0	0	0	0	0	50	50	0

Locations

OD Matrix	Location	Name	Entries	Exits	Colour
1	1	(untitled)	11/1	Cx/1	#0000FF
	2	(untitled)	12/1	Dx/1	#FF0000
	3	(untitled)	9/1	Ax/1	#00FF00
	4	(untitled)	10/1	Bx/1	#FFFF00
	5	(untitled)	3:2E, 1:1E	3:2X, 1:1X	#FF00FF
	6	(untitled)	2:1E, 1:2E	2:1X, 1:2X	#008000
	7	(untitled)	4:2E, 3:1E	4:2X, 3:1X	#FFA500
	8	(untitled)	4:1E, 2:2E	4:1X, 2:2X	#00FFFF

Normal Paths and Flows

OD Matrix	Path	Description	From location	To location	Path items	Allocation type	Normal Calculated Flow (Veh/hr)
1	9		4	3	10/1, B/2, Ax/1	Normal	107
	10		3	4	9/1, A/1, Bx/1	Normal	117
	11		1	3	11/1, C/1, Ax/1	Normal	145
	12		1	4	11/1, C/2, Bx/1	Normal	281
	13		3	1	9/1, A/1, Cx/1	Normal	275
	14		4	1	10/1, B/1, Cx/1	Normal	3
	15		2	3	12/1, D/1, Ax/1	Normal	64
	16		2	4	12/1, D/1, Bx/1	Normal	222
	19		3	2	9/1, A/2, Dx/1	Normal	117
	20		4	2	10/1, B/1, Dx/1	Normal	421
	43		2	1	12/1, D/2, Cx/1	Normal	37
	44		1	2	11/1, C/1, Dx/1	Normal	23

Pedestrian Paths and Flows

OD Matrix	Path	Description	From location	To location	Path items	Allocation type	Pedestrian calculated flow (Ped/hr)
1	17		8	7	4:1E, 4:2X	Normal	50
	18		8	6	2:2E, 2:1X	Normal	50
	22		5	7	3:2E, 3:1X	Normal	50
	23		5	6	1:1E, 1:2X	Normal	50
	34		6	8	2:1E, 2:2X	Normal	50
	35		6	5	1:2E, 1:1X	Normal	50
	41		7	8	4:2E, 4:1X	Normal	50
	42		7	5	3:1E, 3:2X	Normal	50

Signal Timings

Network Default: 120s cycle time; 120 steps

Controller Stream 1

Controller Stream	Name	Description	Use sequence	Cycle time source	Cycle time (s)
1	(untitled)		1	NetworkDefault	120

Controller Stream 1 - Properties

Controller Stream	Manufacturer name	Type	Model number	(Telephone) Line Number	Site number	Grid reference	Gaining delay type
1	Unspecified						Relative

Controller Stream 1 - Optimisation

Controller Stream	Allow offset optimisation	Allow green split optimisation	Optimisation level	Auto redistribute	Enable stage constraint
1	✓	✓	Offsets And Green Splits	✓	

Phases

Controller Stream	Phase	Name	Minimum green (s)	Maximum green (s)	Relative start displacement (s)	Relative end displacement (s)	Type	Blackout Time (s)
1	A	(untitled)	7	70	0	0	Traffic	
	B	(untitled)	7	70	0	0	Traffic	
	C	(untitled)	7	70	0	0	Traffic	
	D	(untitled)	7	70	0	0	Traffic	
	E	(untitled)	5	5	0	0	Pedestrian	0

Library Stages

Controller Stream	Library Stage	Phases in stage	User stage minimum (s)
1	1	A	1
	2	B	1
	3	C	1
	4	D	1
	5	E	1

Stage Sequences

Controller Stream	Sequence	Name	Multiple cycling	Stage IDs	Stage ends
1	1	(untitled)	Single	1, 2, 3, 4, 5	0, 39, 64, 96, 106

Intergreen Matrix for Controller Stream 1

		To				
		A	B	C	D	E
From	A		5	5	5	5
	B	5		5	5	5
	C	5	5		5	5
	D	5	5	5		5
	E	5	5	5	5	

Banned Stage transitions for Controller Stream 1

		To				
		1	2	3	4	5
From	1					
	2					
	3					
	4					
	5					

Interstage Matrix for Controller Stream 1

		To				
		1	2	3	4	5
From	1	0	5	5	5	5
	2	5	0	5	5	5
	3	5	5	0	5	5
	4	5	5	5	0	5
	5	5	5	5	5	0

Resultant Stages

Controller Stream	Resultant Stage	Is base stage	Library Stage ID	Phases in this stage	Stage start (s)	Stage end (s)	Stage duration (s)	User stage minimum (s)	Stage minimum (s)
1	1	✓	1	A	111	0	9	1	7
	2	✓	2	B	5	39	34	1	7
	3	✓	3	C	44	64	20	1	7
	4	✓	4	D	69	96	27	1	7
	5	✓	5	E	101	106	5	1	5

Resultant Phase Green Periods

Controller Stream	Phase	Green period	Is base green period	Start time (s)	End time (s)	Duration (s)
1	A	1	✓	111	0	9
	B	1	✓	5	39	34
	C	1	✓	44	64	20
	D	1	✓	69	96	27
	E	1	✓	101	106	5

Traffic Stream Green Times

Arm	Traffic Stream	Traffic Node	Controller Stream	Phase	Green Period 1		
					Start	End	Duration
A	1	1	1	D	69	96	27
A	2	1	1	C	44	64	20
B	1	1	1	B	5	39	34
B	2	1	1	A	111	0	9
C	1	1	1	D	69	96	27
C	2	1	1	C	44	64	20
D	1	1	1	B	5	39	34
D	2	1	1	A	111	0	9

Phase Timings Diagram for Controller Stream 1

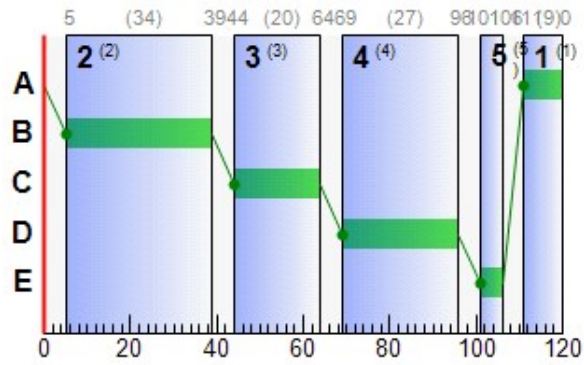

Stage Sequence Diagram for Controller Stream 1

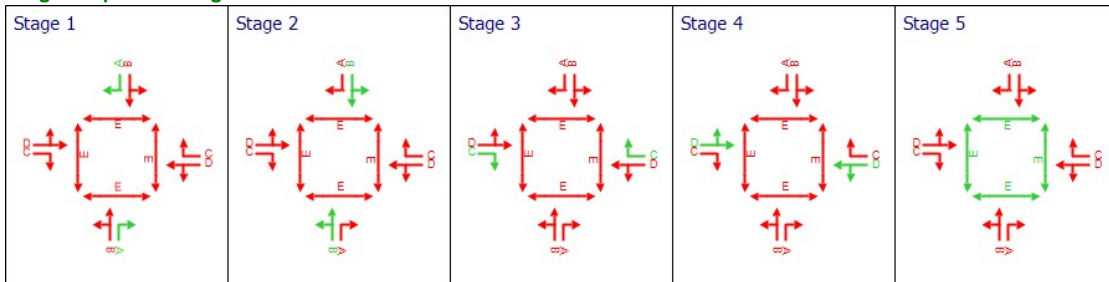

Resultant penalties

Time Segment	Controller stream	Phase min max penalty (£ per hr)	Intergreen broken penalty (£ per hr)	Stage constraint broken penalty (£ per hr)	Cost of controller stream penalties (£ per hr)
17:00-18:00	1	0.00	0.00	0.00	0.00

Traffic Stream Results

Traffic Stream Results: Vehicle summary

Time Segment	Arm	Traffic Stream	Degree of saturation (%)	Practical reserve capacity (%)	Calculated flow entering (Veh/hr)	Calculated sat flow (Veh/hr)	Actual green (s per cycle)	Mean Delay per Veh (s)	Mean max queue (Veh)	Utilised storage (%)	Weighted cost of delay (£ per hr)	Weighted cost of stops (£ per hr)	Performance Index (£ per hr)	
17:00-18:00	A	1	93	7	392	1800	27	87.97	17.41	500.50	136.01	6.34	142.35	
		2	37	169	117	1800	20	47.04	3.52	10.12	21.71	1.31	23.02	
	Ax	1	0	Unrestricted	316	Unrestricted	120	0.00	0.00	0.00	0.00	0.00	0.00	0.00
		2	0	Unrestricted	316	Unrestricted	120	0.00	0.00	0.00	0.00	0.00	0.00	0.00
	B	1	81	24	424	1800	34	53.12	14.69	42.24	88.84	5.42	94.26	
		2	71	40	107	1800	9	81.48	4.28	136.60	34.39	1.58	35.96	
	Bx	1	0	Unrestricted	620	Unrestricted	120	0.00	0.00	0.00	0.00	0.00	0.00	0.00
		2	0	Unrestricted	620	Unrestricted	120	0.00	0.00	0.00	0.00	0.00	0.00	0.00
	C	1	40	150	168	1800	27	41.75	4.85	13.93	27.67	1.80	29.47	
		2	89	12	281	1800	20	86.84	12.13	174.42	96.25	4.43	100.69	
	Cx	1	0	Unrestricted	315	Unrestricted	120	0.00	0.00	0.00	0.00	0.00	0.00	0.00
		2	0	Unrestricted	315	Unrestricted	120	0.00	0.00	0.00	0.00	0.00	0.00	0.00
	D	1	54	84	286	1800	34	39.87	8.35	24.00	44.97	3.08	48.05	
		2	25	305	37	1800	9	55.43	1.19	22.83	8.09	0.44	8.53	
Dx	1	0	Unrestricted	561	Unrestricted	120	0.00	0.00	0.00	0.00	0.00	0.00	0.00	
	2	0	Unrestricted	561	Unrestricted	120	0.00	0.00	0.00	0.00	0.00	0.00	0.00	
9	1	0	Unrestricted	509	Unrestricted	120	0.00	0.00	0.00	0.00	0.00	0.00	0.00	
10	1	0	Unrestricted	531	Unrestricted	120	0.00	0.00	0.00	0.00	0.00	0.00	0.00	
11	1	0	Unrestricted	449	Unrestricted	120	0.00	0.00	0.00	0.00	0.00	0.00	0.00	
12	1	0	Unrestricted	323	Unrestricted	120	0.00	0.00	0.00	0.00	0.00	0.00	0.00	

Traffic Stream Results: Flows and signals

Time Segment	Arm	Traffic Stream	Calculated flow entering (Veh/hr)	Calculated flow out (Veh/hr)	Flow discrepancy (Veh/hr)	Adjusted flow warning	Calculated sat flow (Veh/hr)	Calculated capacity (Veh/hr)	Degree of saturation (%)	DOS Threshold exceeded	Practical reserve capacity (%)	Mean modulus of error	Actual green (s per cycle)
17:00-18:00	A	1	392	392	0		1800	420	93		7	0.00	27
		2	117	117	0		1800	315	37		169	0.00	20
	Ax	1	316	316	0		Unrestricted	Unrestricted	0		Unrestricted	0.81	120
		2	316	316	0		Unrestricted	Unrestricted	0		Unrestricted	0.81	120
	B	1	424	424	0		1800	525	81		24	0.00	34
		2	107	107	0		1800	150	71		40	0.00	9
	Bx	1	620	620	0		Unrestricted	Unrestricted	0		Unrestricted	0.60	120
		2	620	620	0		Unrestricted	Unrestricted	0		Unrestricted	0.60	120
	C	1	168	168	0		1800	420	40		150	0.00	27
		2	281	281	0		1800	315	89		12	0.00	20
	Cx	1	315	315	0		Unrestricted	Unrestricted	0		Unrestricted	1.09	120
		2	315	315	0		Unrestricted	Unrestricted	0		Unrestricted	1.09	120
	D	1	286	286	0		1800	525	54		84	0.00	34
		2	37	37	0		1800	150	25		305	0.00	9
Dx	1	561	561	0		Unrestricted	Unrestricted	0		Unrestricted	0.94	120	
	2	561	561	0		Unrestricted	Unrestricted	0		Unrestricted	0.94	120	
9	1	509	509	0		Unrestricted	Unrestricted	0		Unrestricted	0.00	120	
10	1	531	531	0		Unrestricted	Unrestricted	0		Unrestricted	0.00	120	
11	1	449	449	0		Unrestricted	Unrestricted	0		Unrestricted	0.00	120	
12	1	323	323	0		Unrestricted	Unrestricted	0		Unrestricted	0.00	120	

Traffic Stream Results: Stops and delays

Time Segment	Arm	Traffic Stream	Mean Cruise Time per Veh (s)	Mean Delay per Veh (s)	Uniform delay (Veh-hr/hr)	Random plus oversat delay (Veh-hr/hr)	Weighted cost of delay (£ per hr)	Mean stops per Veh (%)	Uniform stops (Stops per hr)	Random stops (Stops per hr)	Weighted cost of stops (£ per hr)	
17:00-18:00	A	1	2.40	87.97	4.91	4.67	136.01	128.97	377.31	128.27	6.34	
		2	24.00	47.04	1.42	0.11	21.71	89.30	101.22	3.25	1.31	
	Ax	1	21.95	0.00	0.00	0.00	0.00	0.00	0.00	0.00	0.00	0.00
		2	24.00	53.12	4.64	1.62	88.84	101.97	385.18	47.17	5.42	
	B	1	24.00	53.12	4.64	1.62	88.84	101.97	385.18	47.17	5.42	
		2	2.16	81.48	1.59	0.83	34.39	117.61	102.38	23.46	1.58	
	Bx	1	21.41	0.00	0.00	0.00	0.00	0.00	0.00	0.00	0.00	0.00
		2	24.00	41.75	1.82	0.13	27.67	85.46	139.62	3.96	1.80	
	C	1	24.00	41.75	1.82	0.13	27.67	85.46	139.62	3.96	1.80	
		2	4.80	86.84	3.78	3.00	96.25	125.82	270.37	83.18	4.43	
	Cx	1	23.38	0.00	0.00	0.00	0.00	0.00	0.00	0.00	0.00	0.00
		2	24.00	39.87	2.84	0.32	44.97	85.81	235.78	9.63	3.08	
	D	1	24.00	39.87	2.84	0.32	44.97	85.81	235.78	9.63	3.08	
		2	3.60	55.43	0.53	0.04	8.09	95.58	34.17	1.20	0.44	
Dx	1	21.24	0.00	0.00	0.00	0.00	0.00	0.00	0.00	0.00	0.00	
	2	5.82	0.00	0.00	0.00	0.00	0.00	0.00	0.00	0.00	0.00	
9	1	5.82	0.00	0.00	0.00	0.00	0.00	0.00	0.00	0.00	0.00	
10	1	3.78	0.00	0.00	0.00	0.00	0.00	0.00	0.00	0.00	0.00	
11	1	4.44	0.00	0.00	0.00	0.00	0.00	0.00	0.00	0.00	0.00	
12	1	4.12	0.00	0.00	0.00	0.00	0.00	0.00	0.00	0.00	0.00	

Traffic Stream Results: Queues and blocking

Time Segment	Arm	Traffic Stream	Initial queue (Veh)	Mean max queue (Veh)	Max queue storage (Veh)	Utilised storage (%)	Average storage excess queue (Veh)	Average limit excess queue (Veh)	Excess queue penalty (£ per hr)	Wasted time starvation (s per cycle)	Wasted time blocking back (s per cycle)	Wasted time total (s per cycle)	Estimated blocking	
17:00-18:00	A	1	0.00	17.41	3.48	500.50	7.45	0.00	0.00	0.00	0.00	0.00		
		2	0.00	3.52	34.78	10.12	0.00	0.00	0.00	0.00	0.00	0.00	0.00	
	Ax	1	0.00	0.00	31.81	0.00	0.00	0.00	0.00	0.00	33.00	0.00	33.00	
		2	0.00	14.69	34.78	42.24	0.00	0.00	0.00	0.00	0.00	0.00	0.00	
	B	1	0.00	14.69	34.78	42.24	0.00	0.00	0.00	0.00	0.00	0.00	0.00	
		2	0.00	4.28	3.13	136.60	0.19	0.00	0.00	0.00	0.00	0.00	0.00	
	Bx	1	0.00	0.00	31.03	0.00	0.00	0.00	0.00	0.00	16.00	0.00	16.00	
		2	0.00	4.85	34.78	13.93	0.00	0.00	0.00	0.00	0.00	0.00	0.00	
	C	1	0.00	4.85	34.78	13.93	0.00	0.00	0.00	0.00	0.00	0.00	0.00	
		2	0.00	12.13	6.96	174.42	1.45	0.00	0.00	0.00	0.00	0.00	0.00	
	Cx	1	0.00	0.00	33.88	0.00	0.00	0.00	0.00	0.00	58.00	0.00	58.00	
		2	0.00	8.35	34.78	24.00	0.00	0.00	0.00	0.00	0.00	0.00	0.00	
	D	1	0.00	8.35	34.78	24.00	0.00	0.00	0.00	0.00	0.00	0.00	0.00	
		2	0.00	1.19	5.22	22.83	0.00	0.00	0.00	0.00	7.00	0.00	7.00	
Dx	1	0.00	0.00	30.79	0.00	0.00	0.00	0.00	0.00	36.00	0.00	36.00		
	2	0.00	0.00	8.44	0.00	0.00	0.00	0.00	0.00	0.00	120.00	120.00		
9	1	0.00	0.00	8.44	0.00	0.00	0.00	0.00	0.00	0.00	120.00	120.00		
10	1	0.00	0.00	5.47	0.00	0.00	0.00	0.00	0.00	0.00	39.00	39.00		
11	1	0.00	0.00	6.44	0.00	0.00	0.00	0.00	0.00	0.00	67.00	67.00		
12	1	0.00	0.00	5.97	0.00	0.00	0.00	0.00	0.00	0.00	0.00	0.00		

Pedestrian Crossing Results

Pedestrian Crossings: Pedestrian summary

Time Segment	Crossing	Side	Degree of saturation (%)	Calculated Flow Entering (Ped/hr)	Calculated sat flow (Ped/hr)	Actual green (s per cycle)	Mean Delay Per Ped (s)	Mean max queue (Ped)	Weighted cost of delay (£ per hr)	Performance Index (£ per hr)
17:00-18:00	(ALL)	(ALL)	11	50	11000	5	55.58	1.60	10.96	10.96

Pedestrian Crossings: Flows and signals

Time Segment	Crossing	Side	Calculated flow entering (Ped/hr)	Calculated flow out (Ped/hr)	Flow discrepancy (Ped/hr)	Adjusted flow warning	Calculated sat flow (Ped/hr)	Calculated capacity (Ped/hr)	Degree of saturation (%)	DOS Threshold exceeded	Practical reserve capacity (%)	Mean modulus of error	Actual green (s per cycle)
17:00-18:00	(ALL)	(ALL)	50	50	0		11000	458	11		817	0.00	5

Pedestrian Crossings: Stops and delays

Time Segment	Crossing	Side	Mean Cruise Time per Ped (s)	Mean Delay per Ped (s)	Uniform delay (Ped-hr/hr)	Random plus oversat delay (Ped-hr/hr)	Weighted cost of delay (£ per hr)
17:00-18:00	1	1	5.67	55.58	0.77	0.00	10.96
		2	5.67	55.58	0.77	0.00	10.96
	2	1	6.33	55.58	0.77	0.00	10.96
		2	6.33	55.58	0.77	0.00	10.96
	3	1	6.33	55.58	0.77	0.00	10.96
		2	6.33	55.58	0.77	0.00	10.96
	4	1	5.67	55.58	0.77	0.00	10.96
		2	5.67	55.58	0.77	0.00	10.96

Pedestrian Crossings: Queues and blocking

Time Segment	Crossing	Side	Mean max queue (Ped)	Max queue storage (Ped)	Utilised storage (%)	Average storage excess queue (Ped)	Average limit excess queue (Ped)	Excess queue penalty (£ per hr)
17:00-18:00	(ALL)	(ALL)	1.60	10.00	15.97	0.00	0.00	0.00

Network Results

Network Results: Flows and signals

Time Segment	Calculated flow entering (Veh/hr)	Calculated flow out (Veh/hr)	Flow discrepancy (Veh/hr)	Adjusted flow warning	Degree of saturation (%)	DOS Threshold exceeded	Practical reserve capacity (%)	Actual green (s (per cycle))
17:00-18:00	5836	5836	0		93		7	1180

Network Results: Stops and delays

Time Segment	Mean Cruise Time per Veh (s)	Mean Delay per Veh (s)	Uniform delay (Veh-hr/hr)	Random plus oversat delay (Veh-hr/hr)	Weighted cost of delay (£ per hr)	Mean stops per Veh (%)	Uniform stops (Stops per hr)	Random stops (Stops per hr)	Weighted cost of stops (£ per hr)
17:00-18:00	13.15	23.70	27.70	10.72	545.63	33.35	1646.03	300.11	24.40

Network Results: Queues and blocking

Time Segment	Utilised storage (%)	Excess queue penalty (£ per hr)	Wasted time starvation (s (per cycle))	Wasted time blocking back (s (per cycle))	Wasted time total (s (per cycle))
17:00-18:00	500.50	0.00	150.00	226.00	376.00

Final Prediction Table

Traffic Stream Results

Arm	Traffic Stream	Name	Traffic node	SIGNALS		FLOWS		PERFORMANCE				PER PCU			QUEUES
				Controller stream	Phase	Calculated flow entering (Veh/hr)	Calculated sat flow (Veh/hr)	Actual green (s per cycle)	Wasted time total (s per cycle)	Degree of saturation (%)	Practical reserve capacity (%)	JourneyTime (s)	Mean Delay per Veh (s)	Mean stops per Veh (%)	Mean max queue (Veh)
A	1	(untitled)	1	1	D	392 <	1800	27	0.00	93	7	90.37	87.97	128.97	17.41 +
	2		1	1	C	117	1800	20	0.00	37	169	71.04	47.04	89.30	3.52
Ax	1	(untitled)				316	Unrestricted	120	33.00	0	Unrestricted	21.95	0.00	0.00	0.00
B	1	(untitled)	1	1	B	424	1800	34	0.00	81	24	77.12	53.12	101.97	14.69
	2		1	1	A	107 <	1800	9	0.00	71	40	83.64	81.48	117.61	4.28 +
Bx	1	(untitled)				620	Unrestricted	120	16.00	0	Unrestricted	21.41	0.00	0.00	0.00
C	1	(untitled)	1	1	D	168	1800	27	0.00	40	150	65.75	41.75	85.46	4.85
	2		1	1	C	281 <	1800	20	0.00	89	12	91.64	86.84	125.82	12.13 +
Cx	1	(untitled)				315	Unrestricted	120	58.00	0	Unrestricted	23.38	0.00	0.00	0.00
D	1	(untitled)	1	1	B	286	1800	34	0.00	54	84	63.87	39.87	85.81	8.35
	2		1	1	A	37	1800	9	7.00	25	305	59.03	55.43	95.58	1.19
Dx	1	(untitled)				561	Unrestricted	120	36.00	0	Unrestricted	21.24	0.00	0.00	0.00
9	1		1			509	Unrestricted	120	120.00	0	Unrestricted	5.82	0.00	0.00	0.00
10	1		1			531	Unrestricted	120	39.00	0	Unrestricted	3.78	0.00	0.00	0.00
11	1		1			449	Unrestricted	120	67.00	0	Unrestricted	4.44	0.00	0.00	0.00
12	1		1			323	Unrestricted	120	0.00	0	Unrestricted	4.12	0.00	0.00	0.00

Pedestrian Crossing Results

Pedestrian	Side	Name	Traffic node	SIGNALS		FLOWS		PERFORMANCE			PER PED		QUEUES	WEIGHTS	PEN
				Controller stream	Phase	Calculated Flow Entering (Ped/hr)	Calculated sat flow (Ped/hr)	Actual green (s per cycle)	Degree of saturation (%)	Practical reserve capacity (%)	JourneyTime (s)	Mean Delay per Ped (s)	Mean max queue (Ped)	Delay weighting (%)	Co tra pen (£ p
1	1	(untitled)	1	1	E	50	11000	5	11	817	61.25	55.58	1.60	100	0
	2	(untitled)	1	1	E	50	11000	5	11	817	61.25	55.58	1.60	100	0
2	1	(untitled)	1	1	E	50	11000	5	11	817	61.92	55.58	1.60	100	0
	2	(untitled)	1	1	E	50	11000	5	11	817	61.92	55.58	1.60	100	0
3	1	(untitled)	1	1	E	50	11000	5	11	817	61.92	55.58	1.60	100	0
	2	(untitled)	1	1	E	50	11000	5	11	817	61.92	55.58	1.60	100	0
4	1	(untitled)	1	1	E	50	11000	5	11	817	61.25	55.58	1.60	100	0
	2	(untitled)	1	1	E	50	11000	5	11	817	61.25	55.58	1.60	100	0

Network Results

	Distance travelled (PCU-km/hr)	Time spent (PCU-hr/hr)	Mean journey speed (kph)	Uniform delay (Veh-hr/hr)	Random plus oversat delay (Veh-hr/hr)	Weighted cost of delay (£ per hr)	Weighted cost of stops (£ per hr)	Excess queue penalty (£ per hr)	Performance Index (£ per hr)
Normal traffic	619.36	52.89	11.71	21.53	10.72	457.93	24.40	0.00	482.33
Bus	0.00	0.00	0.00	0.00	0.00	0.00	0.00	0.00	0.00
Tram	0.00	0.00	0.00	0.00	0.00	0.00	0.00	0.00	0.00
Pedestrians	3.40	6.84	0.50	6.18	0.00	87.70	0.00	0.00	87.70
TOTAL	622.76	59.74	10.43	27.70	10.72	545.63	24.40	0.00	570.03

- 1 < = adjusted flow warning (upstream links/traffic streams are over-saturated)
- 1 * = Traffic Stream - Normal, Bus or Tram Stop or Delay weighting has been set to a value other than 100%
- 1 ^ = Traffic Stream - Normal, Bus or Tram Stop or Delay Path weighting has been set to a value other than 100%
- 1 + = average link/traffic stream excess queue is greater than 0
- 1 P.I. = PERFORMANCE INDEX

A5 - DO SOMETHING 2024 D5 - DO SOMETHING 2024*

Summary

Data Errors and Warnings

No errors or warnings

Run Summary

Analysis set used	Run start time	Run finish time	Modelling start time (HH:mm)	Network Cycle Time (s)	Performance Index (£ per hr)	Total network delay (Veh-hr/hr)	Highest DOS (%)	Item with highest DOS	Number of oversaturated items	Percentage of oversaturated items (%)	Item with worst signalised PRC	Item with worst unsignalised PRC	Item with worst over PR
5	19/08/2020 12:06:33	19/08/2020 12:06:34	17:00	120	416.42	28.03	79.30	C/2	0	0	C/2	Dx/1	C/

Analysis Set Details

Name	Description	Demand set	Include in report	Locked
DO SOMETHING 2024		D5	✓	

Demand Set Details

Name	Description	Composite	Demand sets	Start time (HH:mm)	Locked
DO SOMETHING 2024				17:00	

Arms and Traffic Streams

Arms

Arm	Name	Description	Traffic node
A	(untitled)		1
Ax	(untitled)		
B	(untitled)		1
Bx	(untitled)		
C	(untitled)		1
Cx	(untitled)		
D	(untitled)		1
Dx	(untitled)		
9			1
10			1
11			1
12			1

Traffic Streams

Arm	Traffic Stream	Name	Description	Auto length	Length (m)	Has Saturation Flow	Saturation flow source	Saturation flow (PCU/hr)	Is signal controlled	Is give way	Traffic type	Allow Nearside Turn On Red
A	1	(untitled)			20.00	✓	Sum of lanes	1800	✓		Normal	
	2				200.00	✓	Sum of lanes	1800	✓		Normal	
Ax	1	(untitled)		✓	182.93						Normal	
B	1	(untitled)			200.00	✓	Sum of lanes	1800	✓		Normal	
	2				18.00	✓	Sum of lanes	1800	✓		Normal	
Bx	1	(untitled)		✓	178.44						Normal	
C	1	(untitled)			200.00	✓	Sum of lanes	1800	✓		Normal	
	2				40.00	✓	Sum of lanes	1800	✓		Normal	
Cx	1	(untitled)		✓	194.82						Normal	
D	1	(untitled)			200.00	✓	Sum of lanes	1800	✓		Normal	
	2				30.00	✓	Sum of lanes	1800	✓		Normal	
Dx	1	(untitled)		✓	177.04						Normal	
9	1			✓	48.53						Normal	
10	1			✓	31.46						Normal	
11	1			✓	37.01						Normal	
12	1			✓	34.36						Normal	

Lanes

Arm	Traffic Stream	Lane	Name	Description	Use RR67	Saturation flow (PCU/hr)
A	1	1	(untitled)			1800
	2	1	(untitled)			1800
Ax	1	1	(untitled)			
B	1	1	(untitled)			1800
	2	1	(untitled)			1800
Bx	1	1	(untitled)			
C	1	1	(untitled)			1800
	2	1	(untitled)			1800
Cx	1	1	(untitled)			
D	1	1	(untitled)			1800
	2	1	(untitled)			1800
Dx	1	1	(untitled)			
9	1	1	(untitled)			
10	1	1	(untitled)			
11	1	1	(untitled)			
12	1	1	(untitled)			

Modelling

Arm	Traffic Stream	Traffic model	Stop weighting multiplier (%)	Delay weighting multiplier (%)	Assignment Cost Weighting (%)	Exclude from results calculation	Max queue storage (PCU)	Has queue limit	Has degree of saturation limit
(ALL)	(ALL)	NetworkDefault	100	100	100		0.00		

Modelling - Advanced

Arm	Traffic Stream	Initial queue (PCU)	Type of Vehicle-in-Service	Vehicle-in-Service	Type of random parameter	Random parameter	Auto cycle time	Cycle time
(ALL)	(ALL)	0.00	NetworkDefault	Not-Included	NetworkDefault	0.50	✓	120

Normal traffic - Modelling

Arm	Traffic Stream	Stop weighting (%)	Delay weighting (%)
(ALL)	(ALL)	100	100

Normal traffic - Advanced

Arm	Traffic Stream	Dispersion type for Normal Traffic
(ALL)	(ALL)	NetworkDefault

Flows

Arm	Traffic Stream	Total Flow (Veh/hr)	Normal Flow (Veh/hr)
A	1	342	342
	2	100	100
Ax	1	265	265
B	1	361	361
	2	91	91
Bx	1	516	516
C	1	137	137
	2	226	226
Cx	1	275	275
D	1	245	245
	2	31	31
Dx	1	477	477
9	1	442	442
10	1	452	452
11	1	363	363
12	1	276	276

Signals

Arm	Traffic Stream	Controller stream	Phase	Second phase enabled
A	1	1	D	
	2	1	C	
B	1	1	B	
	2	1	A	
C	1	1	D	
	2	1	C	
D	1	1	B	
	2	1	A	

Pedestrian Crossings

Pedestrian Crossings

Crossing	Name	Description	Traffic node	Allow walk on red	Crossing type	Length (m)	Cruise time (seconds)	Cruise speed (kph)
1	(untitled)		1		Farside	7.00	4.67	5.40
2	(untitled)		1		Farside	8.00	5.33	5.40
3	(untitled)		1		Farside	8.00	5.33	5.40
4	(untitled)		1		Farside	7.00	4.67	5.40

Pedestrian Crossings - Signals

Crossing	Controller stream	Phase	Second phase enabled
(ALL)	1	E	

Pedestrian Crossings - Sides

Crossing	Side	Saturation flow (Ped/hr)
(ALL)	(ALL)	11000

Pedestrian Crossings - Modelling

Crossing	Side	Delay weighting (%)	Assignment Cost Weighting (%)	Exclude from results calculation	Max queue storage (Ped)	Has queue limit	Has degree of saturation limit
(ALL)	(ALL)	100	100		0.00		

Local OD Matrix - Local Matrix: 1

Local Matrix Options

OD Matrix	Name	Use for point to point table	Auto calculate	Allocation mode	Allow paths past exit locations	Allow looped paths on arms	Allow looped paths on traffic nodes	Copy flows	Matrix to copy flows from	Limit paths by length	Path length limit multiplier	Limit paths by number	Path number limit
1	(untitled)	✓	✓	Path Equalisation	✓		✓			✓	1.25		

Normal Input Flows (Veh/hr)

	To							
	1	2	3	4	5	6	7	8
From 1	0	18	119	226	0	0	0	0
From 2	31	0	55	190	0	0	0	0
From 3	242	100	0	100	0	0	0	0
From 4	2	359	91	0	0	0	0	0
From 5	0	0	0	0	0	0	0	0
From 6	0	0	0	0	0	0	0	0
From 7	0	0	0	0	0	0	0	0
From 8	0	0	0	0	0	0	0	0

Bus Input Flows not shown as they are blank.

Tram Input Flows not shown as they are blank.

Pedestrian Input Flows (Veh/hr)

	To							
	1	2	3	4	5	6	7	8
From 1	0	0	0	0	0	0	0	0
From 2	0	0	0	0	0	0	0	0
From 3	0	0	0	0	0	0	0	0
From 4	0	0	0	0	0	0	0	0
From 5	0	0	0	0	0	50	50	0
From 6	0	0	0	0	50	0	0	50
From 7	0	0	0	0	50	0	0	50
From 8	0	0	0	0	0	50	50	0

Locations

OD Matrix	Location	Name	Entries	Exits	Colour
1	1	(untitled)	11/1	Cx/1	#0000FF
	2	(untitled)	12/1	Dx/1	#FF0000
	3	(untitled)	9/1	Ax/1	#00FF00
	4	(untitled)	10/1	Bx/1	#FFFF00
	5	(untitled)	3:2E, 1:1E	3:2X, 1:1X	#FF00FF
	6	(untitled)	2:1E, 1:2E	2:1X, 1:2X	#008000
	7	(untitled)	4:2E, 3:1E	4:2X, 3:1X	#FFA500
	8	(untitled)	4:1E, 2:2E	4:1X, 2:2X	#00FFFF

Normal Paths and Flows

OD Matrix	Path	Description	From location	To location	Path items	Allocation type	Normal Calculated Flow (Veh/hr)
1	9		4	3	10/1, B/2, Ax/1	Normal	91
	10		3	4	9/1, A/1, Bx/1	Normal	100
	11		1	3	11/1, C/1, Ax/1	Normal	119
	12		1	4	11/1, C/2, Bx/1	Normal	226
	13		3	1	9/1, A/1, Cx/1	Normal	242
	14		4	1	10/1, B/1, Cx/1	Normal	2
	15		2	3	12/1, D/1, Ax/1	Normal	55
	16		2	4	12/1, D/1, Bx/1	Normal	190
	19		3	2	9/1, A/2, Dx/1	Normal	100
	20		4	2	10/1, B/1, Dx/1	Normal	359
	43		2	1	12/1, D/2, Cx/1	Normal	31
	44		1	2	11/1, C/1, Dx/1	Normal	18

Pedestrian Paths and Flows

OD Matrix	Path	Description	From location	To location	Path items	Allocation type	Pedestrian calculated flow (Ped/hr)
1	17		8	7	4:1E, 4:2X	Normal	50
	18		8	6	2:2E, 2:1X	Normal	50
	22		5	7	3:2E, 3:1X	Normal	50
	23		5	6	1:1E, 1:2X	Normal	50
	34		6	8	2:1E, 2:2X	Normal	50
	35		6	5	1:2E, 1:1X	Normal	50
	41		7	8	4:2E, 4:1X	Normal	50
	42		7	5	3:1E, 3:2X	Normal	50

Signal Timings

Network Default: 120s cycle time; 120 steps

Controller Stream 1

Controller Stream	Name	Description	Use sequence	Cycle time source	Cycle time (s)
1	(untitled)		1	NetworkDefault	120

Controller Stream 1 - Properties

Controller Stream	Manufacturer name	Type	Model number	(Telephone) Line Number	Site number	Grid reference	Gaining delay type
1	Unspecified						Relative

Controller Stream 1 - Optimisation

Controller Stream	Allow offset optimisation	Allow green split optimisation	Optimisation level	Auto redistribute	Enable stage constraint
1	✓	✓	Offsets And Green Splits	✓	

Phases

Controller Stream	Phase	Name	Minimum green (s)	Maximum green (s)	Relative start displacement (s)	Relative end displacement (s)	Type	Blackout Time (s)
1	A	(untitled)	7	70	0	0	Traffic	
	B	(untitled)	7	70	0	0	Traffic	
	C	(untitled)	7	70	0	0	Traffic	
	D	(untitled)	7	70	0	0	Traffic	
	E	(untitled)	5	5	0	0	Pedestrian	0

Library Stages

Controller Stream	Library Stage	Phases in stage	User stage minimum (s)
1	1	A	1
	2	B	1
	3	C	1
	4	D	1
	5	E	1

Stage Sequences

Controller Stream	Sequence	Name	Multiple cycling	Stage IDs	Stage ends
1	1	(untitled)	Single	1, 2, 3, 4, 5	0, 40, 63, 96, 106

Intergreen Matrix for Controller Stream 1

		To				
		A	B	C	D	E
From	A		5	5	5	5
	B	5		5	5	5
	C	5	5		5	5
	D	5	5	5		5
	E	5	5	5	5	

Banned Stage transitions for Controller Stream 1

		To				
		1	2	3	4	5
From	1					
	2					
	3					
	4					
	5					

Interstage Matrix for Controller Stream 1

		To				
		1	2	3	4	5
From	1	0	5	5	5	5
	2	5	0	5	5	5
	3	5	5	0	5	5
	4	5	5	5	0	5
	5	5	5	5	5	0

Resultant Stages

Controller Stream	Resultant Stage	Is base stage	Library Stage ID	Phases in this stage	Stage start (s)	Stage end (s)	Stage duration (s)	User stage minimum (s)	Stage minimum (s)
1	1	✓	1	A	111	0	9	1	7
	2	✓	2	B	5	40	35	1	7
	3	✓	3	C	45	63	18	1	7
	4	✓	4	D	68	96	28	1	7
	5	✓	5	E	101	106	5	1	5

Resultant Phase Green Periods

Controller Stream	Phase	Green period	Is base green period	Start time (s)	End time (s)	Duration (s)
1	A	1	✓	111	0	9
	B	1	✓	5	40	35
	C	1	✓	45	63	18
	D	1	✓	68	96	28
	E	1	✓	101	106	5

Traffic Stream Green Times

Arm	Traffic Stream	Traffic Node	Controller Stream	Phase	Green Period 1		
					Start	End	Duration
A	1	1	1	D	68	96	28
A	2	1	1	C	45	63	18
B	1	1	1	B	5	40	35
B	2	1	1	A	111	0	9
C	1	1	1	D	68	96	28
C	2	1	1	C	45	63	18
D	1	1	1	B	5	40	35
D	2	1	1	A	111	0	9

Phase Timings Diagram for Controller Stream 1

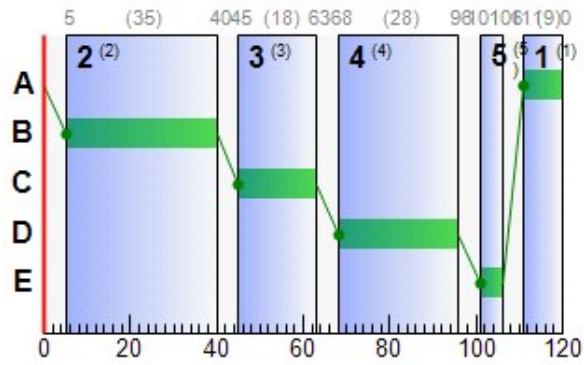

Stage Sequence Diagram for Controller Stream 1

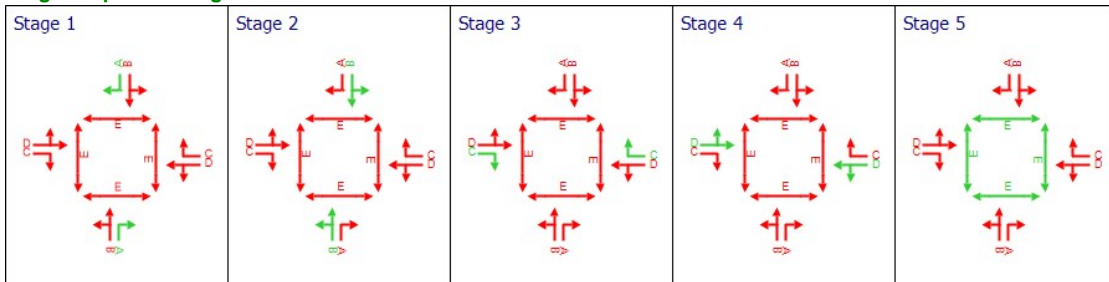

Resultant penalties

Time Segment	Controller stream	Phase min max penalty (£ per hr)	Intergreen broken penalty (£ per hr)	Stage constraint broken penalty (£ per hr)	Cost of controller stream penalties (£ per hr)
17:00-18:00	1	0.00	0.00	0.00	0.00

Traffic Stream Results

Traffic Stream Results: Vehicle summary

Time Segment	Arm	Traffic Stream	Degree of saturation (%)	Practical reserve capacity (%)	Calculated flow entering (Veh/hr)	Calculated sat flow (Veh/hr)	Actual green (s per cycle)	Mean Delay per Veh (s)	Mean max queue (Veh)	Utilised storage (%)	Weighted cost of delay (£ per hr)	Weighted cost of stops (£ per hr)	Performance Index (£ per hr)	
17:00-18:00	A	1	79	27	342	1800	28	57.14	12.02	345.61	77.08	4.45	81.53	
		2	35	185	100	1800	18	48.41	3.04	8.74	19.09	1.13	20.22	
	Ax	1	0	Unrestricted	265	Unrestricted	120	0.00	0.00	0.00	0.00	0.00	0.00	0.00
		2	0	Unrestricted	265	Unrestricted	120	0.00	0.00	0.00	0.00	0.00	0.00	0.00
	B	1	67	50	361	1800	35	43.40	11.19	32.18	61.80	4.13	65.93	
		2	61	65	91	1800	9	70.98	3.36	107.29	25.48	1.25	26.72	
	Bx	1	0	Unrestricted	516	Unrestricted	120	0.00	0.00	0.00	0.00	0.00	0.00	0.00
		2	0	Unrestricted	516	Unrestricted	120	0.00	0.00	0.00	0.00	0.00	0.00	0.00
	C	1	31	218	137	1800	28	39.26	3.80	10.93	21.21	1.41	22.63	
		2	79	26	226	1800	18	71.13	8.63	124.10	63.41	3.19	66.60	
	Cx	1	0	Unrestricted	275	Unrestricted	120	0.00	0.00	0.00	0.00	0.00	0.00	0.00
		2	0	Unrestricted	275	Unrestricted	120	0.00	0.00	0.00	0.00	0.00	0.00	0.00
	D	1	45	120	245	1800	35	36.79	6.79	19.52	35.56	2.51	38.07	
		2	21	384	31	1800	9	54.43	0.98	18.83	6.66	0.37	7.02	
Dx	1	0	Unrestricted	477	Unrestricted	120	0.00	0.00	0.00	0.00	0.00	0.00	0.00	
	2	0	Unrestricted	477	Unrestricted	120	0.00	0.00	0.00	0.00	0.00	0.00	0.00	
9	1	0	Unrestricted	442	Unrestricted	120	0.00	0.00	0.00	0.00	0.00	0.00	0.00	
10	1	0	Unrestricted	452	Unrestricted	120	0.00	0.00	0.00	0.00	0.00	0.00	0.00	
11	1	0	Unrestricted	363	Unrestricted	120	0.00	0.00	0.00	0.00	0.00	0.00	0.00	
12	1	0	Unrestricted	276	Unrestricted	120	0.00	0.00	0.00	0.00	0.00	0.00	0.00	

Traffic Stream Results: Flows and signals

Time Segment	Arm	Traffic Stream	Calculated flow entering (Veh/hr)	Calculated flow out (Veh/hr)	Flow discrepancy (Veh/hr)	Adjusted flow warning	Calculated sat flow (Veh/hr)	Calculated capacity (Veh/hr)	Degree of saturation (%)	DOS Threshold exceeded	Practical reserve capacity (%)	Mean modulus of error	Actual green (s per cycle)
17:00-18:00	A	1	342	342	0		1800	435	79		27	0.00	28
		2	100	100	0		1800	285	35		185	0.00	18
	Ax	1	265	265	0		Unrestricted	Unrestricted	0		Unrestricted	0.83	120
		2	265	265	0		Unrestricted	Unrestricted	0		Unrestricted	0.83	120
	B	1	361	361	0		1800	540	67		50	0.00	35
		2	91	91	0		1800	150	61		65	0.00	9
	Bx	1	516	516	0		Unrestricted	Unrestricted	0		Unrestricted	0.64	120
		2	516	516	0		Unrestricted	Unrestricted	0		Unrestricted	0.64	120
	C	1	137	137	0		1800	435	31		218	0.00	28
		2	226	226	0		1800	285	79		26	0.00	18
	Cx	1	275	275	0		Unrestricted	Unrestricted	0		Unrestricted	1.12	120
		2	275	275	0		Unrestricted	Unrestricted	0		Unrestricted	1.12	120
	D	1	245	245	0		1800	540	45		120	0.00	35
		2	31	31	0		1800	150	21		384	0.00	9
Dx	1	477	477	0		Unrestricted	Unrestricted	0		Unrestricted	0.95	120	
	2	477	477	0		Unrestricted	Unrestricted	0		Unrestricted	0.95	120	
9	1	442	442	0		Unrestricted	Unrestricted	0		Unrestricted	0.00	120	
10	1	452	452	0		Unrestricted	Unrestricted	0		Unrestricted	0.00	120	
11	1	363	363	0		Unrestricted	Unrestricted	0		Unrestricted	0.00	120	
12	1	276	276	0		Unrestricted	Unrestricted	0		Unrestricted	0.00	120	

Traffic Stream Results: Stops and delays

Time Segment	Arm	Traffic Stream	Mean Cruise Time per Veh (s)	Mean Delay per Veh (s)	Uniform delay (Veh-hr/hr)	Random plus oversat delay (Veh-hr/hr)	Weighted cost of delay (£ per hr)	Mean stops per Veh (%)	Uniform stops (Stops per hr)	Random stops (Stops per hr)	Weighted cost of stops (£ per hr)	
17:00-18:00	A	1	2.40	57.14	4.05	1.38	77.08	103.75	314.62	40.21	4.45	
		2	24.00	48.41	1.25	0.09	19.09	90.16	87.35	2.81	1.13	
	Ax	1	21.95	0.00	0.00	0.00	0.00	0.00	0.00	0.00	0.00	0.00
		1	24.00	43.40	3.69	0.66	61.80	91.17	309.46	19.65	4.13	
	B	2	2.16	70.98	1.34	0.45	25.48	109.20	86.31	13.06	1.25	
		1	21.41	0.00	0.00	0.00	0.00	0.00	0.00	0.00	0.00	0.00
	Cx	1	24.00	39.26	1.42	0.07	21.21	82.22	110.49	2.16	1.41	
		2	4.80	71.13	3.05	1.41	63.41	112.63	214.07	40.47	3.19	
	D	1	23.38	0.00	0.00	0.00	0.00	0.00	0.00	0.00	0.00	0.00
		1	24.00	36.79	2.32	0.19	35.56	81.82	194.85	5.60	2.51	
	Dx	2	3.60	54.43	0.44	0.03	6.66	94.09	28.37	0.80	0.37	
		1	21.24	0.00	0.00	0.00	0.00	0.00	0.00	0.00	0.00	0.00
	9	1	5.82	0.00	0.00	0.00	0.00	0.00	0.00	0.00	0.00	0.00
	10	1	3.78	0.00	0.00	0.00	0.00	0.00	0.00	0.00	0.00	0.00
11	1	4.44	0.00	0.00	0.00	0.00	0.00	0.00	0.00	0.00	0.00	
12	1	4.12	0.00	0.00	0.00	0.00	0.00	0.00	0.00	0.00	0.00	

Traffic Stream Results: Queues and blocking

Time Segment	Arm	Traffic Stream	Initial queue (Veh)	Mean max queue (Veh)	Max queue storage (Veh)	Utilised storage (%)	Average storage excess queue (Veh)	Average limit excess queue (Veh)	Excess queue penalty (£ per hr)	Wasted time starvation (s per cycle)	Wasted time blocking back (s per cycle)	Wasted time total (s per cycle)	Estimated blocking
17:00-18:00	A	1	0.00	12.02	3.48	345.61	3.24	0.00	0.00	0.00	0.00	0.00	
		2	0.00	3.04	34.78	8.74	0.00	0.00	0.00	0.00	0.00	0.00	
	Ax	1	0.00	0.00	31.81	0.00	0.00	0.00	0.00	0.00	35.00	0.00	35.00
		1	0.00	11.19	34.78	32.18	0.00	0.00	0.00	0.00	0.00	0.00	0.00
	B	2	0.00	3.36	3.13	107.29	0.01	0.00	0.00	0.00	0.00	0.00	0.00
		1	0.00	0.00	31.03	0.00	0.00	0.00	0.00	0.00	20.00	0.00	20.00
	Cx	1	0.00	3.80	34.78	10.93	0.00	0.00	0.00	0.00	0.00	0.00	0.00
		2	0.00	8.63	6.96	124.10	0.19	0.00	0.00	0.00	0.00	0.00	0.00
	D	1	0.00	0.00	33.88	0.00	0.00	0.00	0.00	0.00	59.00	0.00	59.00
		1	0.00	6.79	34.78	19.52	0.00	0.00	0.00	0.00	0.00	0.00	0.00
	Dx	2	0.00	0.98	5.22	18.83	0.00	0.00	0.00	0.00	8.00	0.00	8.00
		1	0.00	0.00	30.79	0.00	0.00	0.00	0.00	0.00	40.00	0.00	40.00
	9	1	0.00	0.00	8.44	0.00	0.00	0.00	0.00	0.00	90.00	0.00	90.00
	10	1	0.00	0.00	5.47	0.00	0.00	0.00	0.00	0.00	10.00	0.00	10.00
11	1	0.00	0.00	6.44	0.00	0.00	0.00	0.00	0.00	27.00	0.00	27.00	
12	1	0.00	0.00	5.97	0.00	0.00	0.00	0.00	0.00	0.00	0.00	0.00	

Pedestrian Crossing Results

Pedestrian Crossings: Pedestrian summary

Time Segment	Crossing	Side	Degree of saturation (%)	Calculated Flow Entering (Ped/hr)	Calculated sat flow (Ped/hr)	Actual green (s per cycle)	Mean Delay Per Ped (s)	Mean max queue (Ped)	Weighted cost of delay (£ per hr)	Performance Index (£ per hr)
17:00-18:00	(ALL)	(ALL)	11	50	11000	5	55.58	1.60	10.96	10.96

Pedestrian Crossings: Flows and signals

Time Segment	Crossing	Side	Calculated flow entering (Ped/hr)	Calculated flow out (Ped/hr)	Flow discrepancy (Ped/hr)	Adjusted flow warning	Calculated sat flow (Ped/hr)	Calculated capacity (Ped/hr)	Degree of saturation (%)	DOS Threshold exceeded	Practical reserve capacity (%)	Mean modulus of error	Actual green (s per cycle)
17:00-18:00	(ALL)	(ALL)	50	50	0		11000	458	11		817	0.00	5

Pedestrian Crossings: Stops and delays

Time Segment	Crossing	Side	Mean Cruise Time per Ped (s)	Mean Delay per Ped (s)	Uniform delay (Ped-hr/hr)	Random plus oversat delay (Ped-hr/hr)	Weighted cost of delay (£ per hr)
17:00-18:00	1	1	5.67	55.58	0.77	0.00	10.96
		2	5.67	55.58	0.77	0.00	10.96
	2	1	6.33	55.58	0.77	0.00	10.96
		2	6.33	55.58	0.77	0.00	10.96
	3	1	6.33	55.58	0.77	0.00	10.96
		2	6.33	55.58	0.77	0.00	10.96
	4	1	5.67	55.58	0.77	0.00	10.96
		2	5.67	55.58	0.77	0.00	10.96

Pedestrian Crossings: Queues and blocking

Time Segment	Crossing	Side	Mean max queue (Ped)	Max queue storage (Ped)	Utilised storage (%)	Average storage excess queue (Ped)	Average limit excess queue (Ped)	Excess queue penalty (£ per hr)
17:00-18:00	(ALL)	(ALL)	1.60	10.00	15.97	0.00	0.00	0.00

Network Results

Network Results: Flows and signals

Time Segment	Calculated flow entering (Veh/hr)	Calculated flow out (Veh/hr)	Flow discrepancy (Veh/hr)	Adjusted flow warning	Degree of saturation (%)	DOS Threshold exceeded	Practical reserve capacity (%)	Actual green (s (per cycle))
17:00-18:00	4999	4999	0		79		26	1180

Network Results: Stops and delays

Time Segment	Mean Cruise Time per Veh (s)	Mean Delay per Veh (s)	Uniform delay (Veh-hr/hr)	Random plus oversat delay (Veh-hr/hr)	Weighted cost of delay (£ per hr)	Mean stops per Veh (%)	Uniform stops (Stops per hr)	Random stops (Stops per hr)	Weighted cost of stops (£ per hr)
17:00-18:00	13.06	20.18	23.74	4.29	397.99	29.41	1345.52	124.76	18.44

Network Results: Queues and blocking

Time Segment	Utilised storage (%)	Excess queue penalty (£ per hr)	Wasted time starvation (s (per cycle))	Wasted time blocking back (s (per cycle))	Wasted time total (s (per cycle))
17:00-18:00	345.61	0.00	162.00	127.00	289.00

Final Prediction Table

Traffic Stream Results

Arm	Traffic Stream	Name	Traffic node	SIGNALS		FLOWS		PERFORMANCE				PER PCU			QUEUES
				Controller stream	Phase	Calculated flow entering (Veh/hr)	Calculated sat flow (Veh/hr)	Actual green (s per cycle)	Wasted time total (s per cycle)	Degree of saturation (%)	Practical reserve capacity (%)	JourneyTime (s)	Mean Delay per Veh (s)	Mean stops per Veh (%)	Mean max queue (Veh)
A	1	(untitled)	1	1	D	342 <	1800	28	0.00	79	27	59.54	57.14	103.75	12.02 +
	2		1	1	C	100	1800	18	0.00	35	185	72.41	48.41	90.16	3.04
Ax	1	(untitled)				265	Unrestricted	120	35.00	0	Unrestricted	21.95	0.00	0.00	0.00
B	1	(untitled)	1	1	B	361	1800	35	0.00	67	50	67.40	43.40	91.17	11.19
	2		1	1	A	91 <	1800	9	0.00	61	65	73.14	70.98	109.20	3.36 +
Bx	1	(untitled)				516	Unrestricted	120	20.00	0	Unrestricted	21.41	0.00	0.00	0.00
C	1	(untitled)	1	1	D	137	1800	28	0.00	31	218	63.26	39.26	82.22	3.80
	2		1	1	C	226 <	1800	18	0.00	79	26	75.93	71.13	112.63	8.63 +
Cx	1	(untitled)				275	Unrestricted	120	59.00	0	Unrestricted	23.38	0.00	0.00	0.00
D	1	(untitled)	1	1	B	245	1800	35	0.00	45	120	60.79	36.79	81.82	6.79
	2		1	1	A	31	1800	9	8.00	21	384	58.03	54.43	94.09	0.98
Dx	1	(untitled)				477	Unrestricted	120	40.00	0	Unrestricted	21.24	0.00	0.00	0.00
9	1		1			442	Unrestricted	120	90.00	0	Unrestricted	5.82	0.00	0.00	0.00
10	1		1			452	Unrestricted	120	10.00	0	Unrestricted	3.78	0.00	0.00	0.00
11	1		1			363	Unrestricted	120	27.00	0	Unrestricted	4.44	0.00	0.00	0.00
12	1		1			276	Unrestricted	120	0.00	0	Unrestricted	4.12	0.00	0.00	0.00

Pedestrian Crossing Results

Pedestrian	Side	Name	Traffic node	SIGNALS		FLOWS		PERFORMANCE			PER PED		QUEUES	WEIGHTS	PEN
				Controller stream	Phase	Calculated Flow Entering (Ped/hr)	Calculated sat flow (Ped/hr)	Actual green (s per cycle)	Degree of saturation (%)	Practical reserve capacity (%)	JourneyTime (s)	Mean Delay per Ped (s)	Mean max queue (Ped)	Delay weighting (%)	Co tra pen (£ p
1	1	(untitled)	1	1	E	50	11000	5	11	817	61.25	55.58	1.60	100	0
	2	(untitled)	1	1	E	50	11000	5	11	817	61.25	55.58	1.60	100	0
2	1	(untitled)	1	1	E	50	11000	5	11	817	61.92	55.58	1.60	100	0
	2	(untitled)	1	1	E	50	11000	5	11	817	61.92	55.58	1.60	100	0
3	1	(untitled)	1	1	E	50	11000	5	11	817	61.92	55.58	1.60	100	0
	2	(untitled)	1	1	E	50	11000	5	11	817	61.92	55.58	1.60	100	0
4	1	(untitled)	1	1	E	50	11000	5	11	817	61.25	55.58	1.60	100	0
	2	(untitled)	1	1	E	50	11000	5	11	817	61.25	55.58	1.60	100	0

Network Results

	Distance travelled (PCU-km/hr)	Time spent (PCU-hr/hr)	Mean journey speed (kph)	Uniform delay (Veh-hr/hr)	Random plus oversat delay (Veh-hr/hr)	Weighted cost of delay (£ per hr)	Weighted cost of stops (£ per hr)	Excess queue penalty (£ per hr)	Performance Index (£ per hr)
Normal traffic	524.21	39.32	13.33	17.56	4.29	310.29	18.44	0.00	328.72
Bus	0.00	0.00	0.00	0.00	0.00	0.00	0.00	0.00	0.00
Tram	0.00	0.00	0.00	0.00	0.00	0.00	0.00	0.00	0.00
Pedestrians	3.40	6.84	0.50	6.18	0.00	87.70	0.00	0.00	87.70
TOTAL	527.61	46.17	11.43	23.74	4.29	397.99	18.44	0.00	416.42

- 1 < = adjusted flow warning (upstream links/traffic streams are over-saturated)
- 1 * = Traffic Stream - Normal, Bus or Tram Stop or Delay weighting has been set to a value other than 100%
- 1 ^ = Traffic Stream - Normal, Bus or Tram Stop or Delay Path weighting has been set to a value other than 100%
- 1 + = average link/traffic stream excess queue is greater than 0
- 1 P.I. = PERFORMANCE INDEX

A6 - DO SOMETHING 2029 D6 - DO SOMETHING 2029*

Summary

Data Errors and Warnings

No errors or warnings

Run Summary

Analysis set used	Run start time	Run finish time	Modelling start time (HH:mm)	Network Cycle Time (s)	Performance Index (£ per hr)	Total network delay (Veh-hr/hr)	Highest DOS (%)	Item with highest DOS	Number of oversaturated items	Percentage of oversaturated items (%)	Item with worst signalised PRC	Item with worst unsignalised PRC	Item with worst over PR
6	19/08/2020 12:06:34	19/08/2020 12:06:35	17:00	120	509.42	34.30	88.05	A/1	0	0	A/1	Dx/1	A/

Analysis Set Details

Name	Description	Demand set	Include in report	Locked
DO SOMETHING 2029		D6	✓	

Demand Set Details

Name	Description	Composite	Demand sets	Start time (HH:mm)	Locked
DO SOMETHING 2029				17:00	

Arms and Traffic Streams

Arms

Arm	Name	Description	Traffic node
A	(untitled)		1
Ax	(untitled)		
B	(untitled)		1
Bx	(untitled)		
C	(untitled)		1
Cx	(untitled)		
D	(untitled)		1
Dx	(untitled)		
9			1
10			1
11			1
12			1

Traffic Streams

Arm	Traffic Stream	Name	Description	Auto length	Length (m)	Has Saturation Flow	Saturation flow source	Saturation flow (PCU/hr)	Is signal controlled	Is give way	Traffic type	Allow Nearside Turn On Red
A	1	(untitled)			20.00	✓	Sum of lanes	1800	✓		Normal	
	2				200.00	✓	Sum of lanes	1800	✓		Normal	
Ax	1	(untitled)		✓	182.93						Normal	
B	1	(untitled)			200.00	✓	Sum of lanes	1800	✓		Normal	
	2				18.00	✓	Sum of lanes	1800	✓		Normal	
Bx	1	(untitled)		✓	178.44						Normal	
C	1	(untitled)			200.00	✓	Sum of lanes	1800	✓		Normal	
	2				40.00	✓	Sum of lanes	1800	✓		Normal	
Cx	1	(untitled)		✓	194.82						Normal	
D	1	(untitled)			200.00	✓	Sum of lanes	1800	✓		Normal	
	2				30.00	✓	Sum of lanes	1800	✓		Normal	
Dx	1	(untitled)		✓	177.04						Normal	
9	1			✓	48.53						Normal	
10	1			✓	31.46						Normal	
11	1			✓	37.01						Normal	
12	1			✓	34.36						Normal	

Lanes

Arm	Traffic Stream	Lane	Name	Description	Use RR67	Saturation flow (PCU/hr)
A	1	1	(untitled)			1800
	2	1	(untitled)			1800
Ax	1	1	(untitled)			
B	1	1	(untitled)			1800
	2	1	(untitled)			1800
Bx	1	1	(untitled)			
C	1	1	(untitled)			1800
	2	1	(untitled)			1800
Cx	1	1	(untitled)			
D	1	1	(untitled)			1800
	2	1	(untitled)			1800
Dx	1	1	(untitled)			
9	1	1	(untitled)			
10	1	1	(untitled)			
11	1	1	(untitled)			
12	1	1	(untitled)			

Modelling

Arm	Traffic Stream	Traffic model	Stop weighting multiplier (%)	Delay weighting multiplier (%)	Assignment Cost Weighting (%)	Exclude from results calculation	Max queue storage (PCU)	Has queue limit	Has degree of saturation limit
(ALL)	(ALL)	NetworkDefault	100	100	100		0.00		

Modelling - Advanced

Arm	Traffic Stream	Initial queue (PCU)	Type of Vehicle-in-Service	Vehicle-in-Service	Type of random parameter	Random parameter	Auto cycle time	Cycle time
(ALL)	(ALL)	0.00	NetworkDefault	Not-Included	NetworkDefault	0.50	✓	120

Normal traffic - Modelling

Arm	Traffic Stream	Stop weighting (%)	Delay weighting (%)
(ALL)	(ALL)	100	100

Normal traffic - Advanced

Arm	Traffic Stream	Dispersion type for Normal Traffic
(ALL)	(ALL)	NetworkDefault

Flows

Arm	Traffic Stream	Total Flow (Veh/hr)	Normal Flow (Veh/hr)
A	1	383	383
	2	109	109
Ax	1	306	306
B	1	393	393
	2	99	99
Bx	1	596	596
C	1	168	168
	2	280	280
Cx	1	311	311
D	1	267	267
	2	35	35
Dx	1	521	521
9	1	492	492
10	1	492	492
11	1	448	448
12	1	302	302

Signals

Arm	Traffic Stream	Controller stream	Phase	Second phase enabled
A	1	1	D	
	2	1	C	
B	1	1	B	
	2	1	A	
C	1	1	D	
	2	1	C	
D	1	1	B	
	2	1	A	

Pedestrian Crossings

Pedestrian Crossings

Crossing	Name	Description	Traffic node	Allow walk on red	Crossing type	Length (m)	Cruise time (seconds)	Cruise speed (kph)
1	(untitled)		1		Farside	7.00	4.67	5.40
2	(untitled)		1		Farside	8.00	5.33	5.40
3	(untitled)		1		Farside	8.00	5.33	5.40
4	(untitled)		1		Farside	7.00	4.67	5.40

Pedestrian Crossings - Signals

Crossing	Controller stream	Phase	Second phase enabled
(ALL)	1	E	

Pedestrian Crossings - Sides

Crossing	Side	Saturation flow (Ped/hr)
(ALL)	(ALL)	11000

Pedestrian Crossings - Modelling

Crossing	Side	Delay weighting (%)	Assignment Cost Weighting (%)	Exclude from results calculation	Max queue storage (Ped)	Has queue limit	Has degree of saturation limit
(ALL)	(ALL)	100	100		0.00		

Local OD Matrix - Local Matrix: 1

Local Matrix Options

OD Matrix	Name	Use for point to point table	Auto calculate	Allocation mode	Allow paths past exit locations	Allow looped paths on arms	Allow looped paths on traffic nodes	Copy flows	Matrix to copy flows from	Limit paths by length	Path length limit multiplier	Limit paths by number	Path number limit
1	(untitled)	✓	✓	Path Equalisation	✓		✓			✓	1.25		

Normal Input Flows (Veh/hr)

	To							
	1	2	3	4	5	6	7	8
From 1	0	21	147	280	0	0	0	0
From 2	35	0	60	207	0	0	0	0
From 3	274	109	0	109	0	0	0	0
From 4	2	391	99	0	0	0	0	0
From 5	0	0	0	0	0	0	0	0
From 6	0	0	0	0	0	0	0	0
From 7	0	0	0	0	0	0	0	0
From 8	0	0	0	0	0	0	0	0

Bus Input Flows not shown as they are blank.

Tram Input Flows not shown as they are blank.

Pedestrian Input Flows (Veh/hr)

	To							
	1	2	3	4	5	6	7	8
From 1	0	0	0	0	0	0	0	0
From 2	0	0	0	0	0	0	0	0
From 3	0	0	0	0	0	0	0	0
From 4	0	0	0	0	0	0	0	0
From 5	0	0	0	0	0	50	50	0
From 6	0	0	0	0	50	0	0	50
From 7	0	0	0	0	50	0	0	50
From 8	0	0	0	0	0	50	50	0

Locations

OD Matrix	Location	Name	Entries	Exits	Colour
1	1	(untitled)	11/1	Cx/1	#0000FF
	2	(untitled)	12/1	Dx/1	#FF0000
	3	(untitled)	9/1	Ax/1	#00FF00
	4	(untitled)	10/1	Bx/1	#FFFF00
	5	(untitled)	3:2E, 1:1E	3:2X, 1:1X	#FF00FF
	6	(untitled)	2:1E, 1:2E	2:1X, 1:2X	#008000
	7	(untitled)	4:2E, 3:1E	4:2X, 3:1X	#FFA500
	8	(untitled)	4:1E, 2:2E	4:1X, 2:2X	#00FFFF

Normal Paths and Flows

OD Matrix	Path	Description	From location	To location	Path items	Allocation type	Normal Calculated Flow (Veh/hr)
1	9		4	3	10/1, B/2, Ax/1	Normal	99
	10		3	4	9/1, A/1, Bx/1	Normal	109
	11		1	3	11/1, C/1, Ax/1	Normal	147
	12		1	4	11/1, C/2, Bx/1	Normal	280
	13		3	1	9/1, A/1, Cx/1	Normal	274
	14		4	1	10/1, B/1, Cx/1	Normal	2
	15		2	3	12/1, D/1, Ax/1	Normal	60
	16		2	4	12/1, D/1, Bx/1	Normal	207
	19		3	2	9/1, A/2, Dx/1	Normal	109
	20		4	2	10/1, B/1, Dx/1	Normal	391
	43		2	1	12/1, D/2, Cx/1	Normal	35
	44		1	2	11/1, C/1, Dx/1	Normal	21

Pedestrian Paths and Flows

OD Matrix	Path	Description	From location	To location	Path items	Allocation type	Pedestrian calculated flow (Ped/hr)
1	17		8	7	4:1E, 4:2X	Normal	50
	18		8	6	2:2E, 2:1X	Normal	50
	22		5	7	3:2E, 3:1X	Normal	50
	23		5	6	1:1E, 1:2X	Normal	50
	34		6	8	2:1E, 2:2X	Normal	50
	35		6	5	1:2E, 1:1X	Normal	50
	41		7	8	4:2E, 4:1X	Normal	50
	42		7	5	3:1E, 3:2X	Normal	50

Signal Timings

Network Default: 120s cycle time; 120 steps

Controller Stream 1

Controller Stream	Name	Description	Use sequence	Cycle time source	Cycle time (s)
1	(untitled)		1	NetworkDefault	120

Controller Stream 1 - Properties

Controller Stream	Manufacturer name	Type	Model number	(Telephone) Line Number	Site number	Grid reference	Gaining delay type
1	Unspecified						Relative

Controller Stream 1 - Optimisation

Controller Stream	Allow offset optimisation	Allow green split optimisation	Optimisation level	Auto redistribute	Enable stage constraint
1	✓	✓	Offsets And Green Splits	✓	

Phases

Controller Stream	Phase	Name	Minimum green (s)	Maximum green (s)	Relative start displacement (s)	Relative end displacement (s)	Type	Blackout Time (s)
1	A	(untitled)	7	70	0	0	Traffic	
	B	(untitled)	7	70	0	0	Traffic	
	C	(untitled)	7	70	0	0	Traffic	
	D	(untitled)	7	70	0	0	Traffic	
	E	(untitled)	5	5	0	0	Pedestrian	0

Library Stages

Controller Stream	Library Stage	Phases in stage	User stage minimum (s)
1	1	A	1
	2	B	1
	3	C	1
	4	D	1
	5	E	1

Stage Sequences

Controller Stream	Sequence	Name	Multiple cycling	Stage IDs	Stage ends
1	1	(untitled)	Single	1, 2, 3, 4, 5	0, 37, 63, 96, 106

Intergreen Matrix for Controller Stream 1

		To				
		A	B	C	D	E
From	A		5	5	5	5
	B	5		5	5	5
	C	5	5		5	5
	D	5	5	5		5
	E	5	5	5	5	

Banned Stage transitions for Controller Stream 1

		To				
		1	2	3	4	5
From	1					
	2					
	3					
	4					
	5					

Interstage Matrix for Controller Stream 1

		To				
		1	2	3	4	5
From	1	0	5	5	5	5
	2	5	0	5	5	5
	3	5	5	0	5	5
	4	5	5	5	0	5
	5	5	5	5	5	0

Resultant Stages

Controller Stream	Resultant Stage	Is base stage	Library Stage ID	Phases in this stage	Stage start (s)	Stage end (s)	Stage duration (s)	User stage minimum (s)	Stage minimum (s)
1	1	✓	1	A	111	0	9	1	7
	2	✓	2	B	5	37	32	1	7
	3	✓	3	C	42	63	21	1	7
	4	✓	4	D	68	96	28	1	7
	5	✓	5	E	101	106	5	1	5

Resultant Phase Green Periods

Controller Stream	Phase	Green period	Is base green period	Start time (s)	End time (s)	Duration (s)
1	A	1	✓	111	0	9
	B	1	✓	5	37	32
	C	1	✓	42	63	21
	D	1	✓	68	96	28
	E	1	✓	101	106	5

Traffic Stream Green Times

Arm	Traffic Stream	Traffic Node	Controller Stream	Phase	Green Period 1		
					Start	End	Duration
A	1	1	1	D	68	96	28
A	2	1	1	C	42	63	21
B	1	1	1	B	5	37	32
B	2	1	1	A	111	0	9
C	1	1	1	D	68	96	28
C	2	1	1	C	42	63	21
D	1	1	1	B	5	37	32
D	2	1	1	A	111	0	9

Phase Timings Diagram for Controller Stream 1

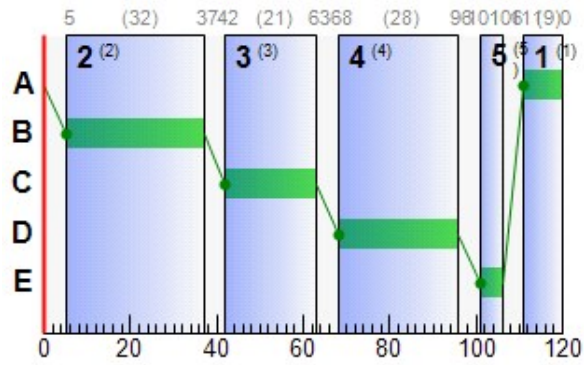

Stage Sequence Diagram for Controller Stream 1

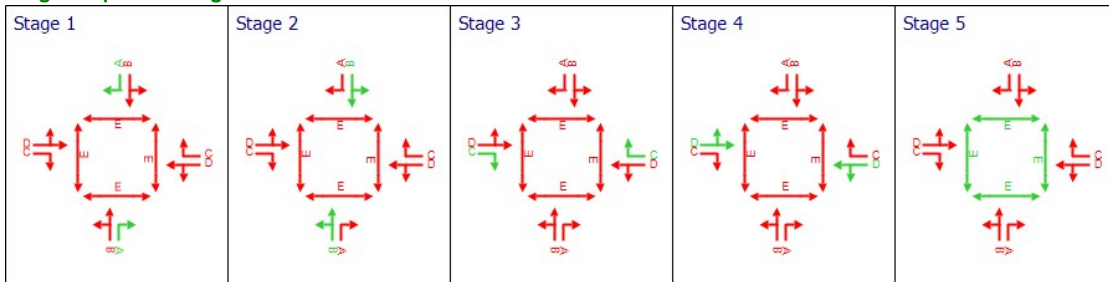

Resultant penalties

Time Segment	Controller stream	Phase min max penalty (£ per hr)	Intergreen broken penalty (£ per hr)	Stage constraint broken penalty (£ per hr)	Cost of controller stream penalties (£ per hr)
17:00-18:00	1	0.00	0.00	0.00	0.00

Traffic Stream Results

Traffic Stream Results: Vehicle summary

Time Segment	Arm	Traffic Stream	Degree of saturation (%)	Practical reserve capacity (%)	Calculated flow entering (Veh/hr)	Calculated sat flow (Veh/hr)	Actual green (s per cycle)	Mean Delay per Veh (s)	Mean max queue (Veh)	Utilised storage (%)	Weighted cost of delay (£ per hr)	Weighted cost of stops (£ per hr)	Performance Index (£ per hr)	
17:00-18:00	A	1	88	14	383	1800	28	70.50	15.07	433.32	106.51	5.55	112.07	
		2	33	203	109	1800	21	45.29	3.23	9.29	19.47	1.20	20.67	
	Ax	1	0	Unrestricted	306	Unrestricted	120	0.00	0.00	0.00	0.00	0.00	0.00	0.00
		2	0	Unrestricted	306	Unrestricted	120	0.00	0.00	0.00	0.00	0.00	0.00	0.00
	B	1	79	26	393	1800	32	53.77	13.58	39.05	83.35	5.02	88.37	
		2	66	52	99	1800	9	75.56	3.80	121.40	29.51	1.41	30.91	
	Bx	1	0	Unrestricted	596	Unrestricted	120	0.00	0.00	0.00	0.00	0.00	0.00	0.00
		2	0	Unrestricted	596	Unrestricted	120	0.00	0.00	0.00	0.00	0.00	0.00	0.00
	C	1	39	159	168	1800	28	40.66	4.79	13.76	26.94	1.78	28.72	
		2	85	18	280	1800	21	74.70	11.15	160.22	82.50	4.09	86.59	
	Cx	1	0	Unrestricted	311	Unrestricted	120	0.00	0.00	0.00	0.00	0.00	0.00	0.00
		2	0	Unrestricted	311	Unrestricted	120	0.00	0.00	0.00	0.00	0.00	0.00	0.00
	D	1	54	85	267	1800	32	41.26	7.88	22.65	43.45	2.91	46.37	
		2	23	329	35	1800	9	55.08	1.12	21.55	7.60	0.42	8.02	
Dx	1	0	Unrestricted	521	Unrestricted	120	0.00	0.00	0.00	0.00	0.00	0.00	0.00	
	2	0	Unrestricted	521	Unrestricted	120	0.00	0.00	0.00	0.00	0.00	0.00	0.00	
9	1	0	Unrestricted	492	Unrestricted	120	0.00	0.00	0.00	0.00	0.00	0.00	0.00	
10	1	0	Unrestricted	492	Unrestricted	120	0.00	0.00	0.00	0.00	0.00	0.00	0.00	
11	1	0	Unrestricted	448	Unrestricted	120	0.00	0.00	0.00	0.00	0.00	0.00	0.00	
12	1	0	Unrestricted	302	Unrestricted	120	0.00	0.00	0.00	0.00	0.00	0.00	0.00	

Traffic Stream Results: Flows and signals

Time Segment	Arm	Traffic Stream	Calculated flow entering (Veh/hr)	Calculated flow out (Veh/hr)	Flow discrepancy (Veh/hr)	Adjusted flow warning	Calculated sat flow (Veh/hr)	Calculated capacity (Veh/hr)	Degree of saturation (%)	DOS Threshold exceeded	Practical reserve capacity (%)	Mean modulus of error	Actual green (s per cycle)
17:00-18:00	A	1	383	383	0		1800	435	88		14	0.00	28
		2	109	109	0		1800	330	33		203	0.00	21
	Ax	1	306	306	0		Unrestricted	Unrestricted	0		Unrestricted	0.81	120
		2	306	306	0		Unrestricted	Unrestricted	0		Unrestricted	0.81	120
	B	1	393	393	0		1800	495	79		26	0.00	32
		2	99	99	0		1800	150	66		52	0.00	9
	Bx	1	596	596	0		Unrestricted	Unrestricted	0		Unrestricted	0.63	120
		2	596	596	0		Unrestricted	Unrestricted	0		Unrestricted	0.63	120
	C	1	168	168	0		1800	435	39		159	0.00	28
		2	280	280	0		1800	330	85		18	0.00	21
	Cx	1	311	311	0		Unrestricted	Unrestricted	0		Unrestricted	1.10	120
		2	311	311	0		Unrestricted	Unrestricted	0		Unrestricted	1.10	120
	D	1	267	267	0		1800	495	54		85	0.00	32
		2	35	35	0		1800	150	23		329	0.00	9
Dx	1	521	521	0		Unrestricted	Unrestricted	0		Unrestricted	0.97	120	
	2	521	521	0		Unrestricted	Unrestricted	0		Unrestricted	0.97	120	
9	1	492	492	0		Unrestricted	Unrestricted	0		Unrestricted	0.00	120	
10	1	492	492	0		Unrestricted	Unrestricted	0		Unrestricted	0.00	120	
11	1	448	448	0		Unrestricted	Unrestricted	0		Unrestricted	0.00	120	
12	1	302	302	0		Unrestricted	Unrestricted	0		Unrestricted	0.00	120	

Traffic Stream Results: Stops and delays

Time Segment	Arm	Traffic Stream	Mean Cruise Time per Veh (s)	Mean Delay per Veh (s)	Uniform delay (Veh-hr/hr)	Random plus oversat delay (Veh-hr/hr)	Weighted cost of delay (£ per hr)	Mean stops per Veh (%)	Uniform stops (Stops per hr)	Random stops (Stops per hr)	Weighted cost of stops (£ per hr)	
17:00-18:00	A	1	2.40	70.50	4.66	2.84	106.51	115.62	362.28	80.56	5.55	
		2	24.00	45.29	1.29	0.08	19.47	87.84	93.32	2.42	1.20	
	Ax	1	21.95	0.00	0.00	0.00	0.00	0.00	0.00	0.00	0.00	0.00
		2	24.00	53.77	4.40	1.46	83.35	101.95	357.91	42.74	5.02	
	B	1	24.00	53.77	4.40	1.46	83.35	101.95	357.91	42.74	5.02	
		2	2.16	75.56	1.47	0.61	29.51	113.33	94.71	17.49	1.41	
	Bx	1	21.41	0.00	0.00	0.00	0.00	0.00	0.00	0.00	0.00	0.00
		2	24.00	40.66	1.78	0.12	26.94	84.37	138.14	3.61	1.78	
	C	1	24.00	40.66	1.78	0.12	26.94	84.37	138.14	3.61	1.78	
		2	4.80	74.70	3.69	2.12	82.50	116.45	265.83	60.22	4.09	
	Cx	1	23.38	0.00	0.00	0.00	0.00	0.00	0.00	0.00	0.00	0.00
		2	24.00	41.26	2.75	0.31	43.45	87.05	223.10	9.32	2.91	
	D	1	24.00	41.26	2.75	0.31	43.45	87.05	223.10	9.32	2.91	
		2	3.60	55.08	0.50	0.04	7.60	95.35	32.32	1.05	0.42	
Dx	1	21.24	0.00	0.00	0.00	0.00	0.00	0.00	0.00	0.00	0.00	
	2	5.82	0.00	0.00	0.00	0.00	0.00	0.00	0.00	0.00	0.00	
9	1	5.82	0.00	0.00	0.00	0.00	0.00	0.00	0.00	0.00	0.00	
10	1	3.78	0.00	0.00	0.00	0.00	0.00	0.00	0.00	0.00	0.00	
11	1	4.44	0.00	0.00	0.00	0.00	0.00	0.00	0.00	0.00	0.00	
12	1	4.12	0.00	0.00	0.00	0.00	0.00	0.00	0.00	0.00	0.00	

Traffic Stream Results: Queues and blocking

Time Segment	Arm	Traffic Stream	Initial queue (Veh)	Mean max queue (Veh)	Max queue storage (Veh)	Utilised storage (%)	Average storage excess queue (Veh)	Average limit excess queue (Veh)	Excess queue penalty (£ per hr)	Wasted time starvation (s per cycle)	Wasted time blocking back (s per cycle)	Wasted time total (s per cycle)	Estimated blocking	
17:00-18:00	A	1	0.00	15.07	3.48	433.32	5.31	0.00	0.00	0.00	0.00	0.00		
		2	0.00	3.23	34.78	9.29	0.00	0.00	0.00	0.00	0.00	0.00	0.00	
	Ax	1	0.00	0.00	31.81	0.00	0.00	0.00	0.00	0.00	34.00	0.00	34.00	
		2	0.00	13.58	34.78	39.05	0.00	0.00	0.00	0.00	0.00	0.00	0.00	
	B	1	0.00	13.58	34.78	39.05	0.00	0.00	0.00	0.00	0.00	0.00	0.00	
		2	0.00	3.80	3.13	121.40	0.07	0.00	0.00	0.00	0.00	0.00	0.00	
	Bx	1	0.00	0.00	31.03	0.00	0.00	0.00	0.00	0.00	18.00	0.00	18.00	
		2	0.00	4.79	34.78	13.76	0.00	0.00	0.00	0.00	0.00	0.00	0.00	
	C	1	0.00	4.79	34.78	13.76	0.00	0.00	0.00	0.00	0.00	0.00	0.00	
		2	0.00	11.15	6.96	160.22	0.96	0.00	0.00	0.00	0.00	0.00	0.00	
	Cx	1	0.00	0.00	33.88	0.00	0.00	0.00	0.00	0.00	58.00	0.00	58.00	
		2	0.00	7.88	34.78	22.65	0.00	0.00	0.00	0.00	0.00	0.00	0.00	
	D	1	0.00	7.88	34.78	22.65	0.00	0.00	0.00	0.00	0.00	0.00	0.00	
		2	0.00	1.12	5.22	21.55	0.00	0.00	0.00	0.00	7.00	0.00	7.00	
Dx	1	0.00	0.00	30.79	0.00	0.00	0.00	0.00	0.00	38.00	0.00	38.00		
	2	0.00	0.00	8.44	0.00	0.00	0.00	0.00	0.00	0.00	109.00	109.00		
9	1	0.00	0.00	8.44	0.00	0.00	0.00	0.00	0.00	0.00	109.00	109.00		
10	1	0.00	0.00	5.47	0.00	0.00	0.00	0.00	0.00	0.00	25.00	25.00		
11	1	0.00	0.00	6.44	0.00	0.00	0.00	0.00	0.00	0.00	54.00	54.00		
12	1	0.00	0.00	5.97	0.00	0.00	0.00	0.00	0.00	0.00	0.00	0.00		

Pedestrian Crossing Results

Pedestrian Crossings: Pedestrian summary

Time Segment	Crossing	Side	Degree of saturation (%)	Calculated Flow Entering (Ped/hr)	Calculated sat flow (Ped/hr)	Actual green (s per cycle)	Mean Delay Per Ped (s)	Mean max queue (Ped)	Weighted cost of delay (£ per hr)	Performance Index (£ per hr)
17:00-18:00	(ALL)	(ALL)	11	50	11000	5	55.58	1.60	10.96	10.96

Pedestrian Crossings: Flows and signals

Time Segment	Crossing	Side	Calculated flow entering (Ped/hr)	Calculated flow out (Ped/hr)	Flow discrepancy (Ped/hr)	Adjusted flow warning	Calculated sat flow (Ped/hr)	Calculated capacity (Ped/hr)	Degree of saturation (%)	DOS Threshold exceeded	Practical reserve capacity (%)	Mean modulus of error	Actual green (s per cycle)
17:00-18:00	(ALL)	(ALL)	50	50	0		11000	458	11		817	0.00	5

Pedestrian Crossings: Stops and delays

Time Segment	Crossing	Side	Mean Cruise Time per Ped (s)	Mean Delay per Ped (s)	Uniform delay (Ped-hr/hr)	Random plus oversat delay (Ped-hr/hr)	Weighted cost of delay (£ per hr)
17:00-18:00	1	1	5.67	55.58	0.77	0.00	10.96
		2	5.67	55.58	0.77	0.00	10.96
	2	1	6.33	55.58	0.77	0.00	10.96
		2	6.33	55.58	0.77	0.00	10.96
	3	1	6.33	55.58	0.77	0.00	10.96
		2	6.33	55.58	0.77	0.00	10.96
	4	1	5.67	55.58	0.77	0.00	10.96
		2	5.67	55.58	0.77	0.00	10.96

Pedestrian Crossings: Queues and blocking

Time Segment	Crossing	Side	Mean max queue (Ped)	Max queue storage (Ped)	Utilised storage (%)	Average storage excess queue (Ped)	Average limit excess queue (Ped)	Excess queue penalty (£ per hr)
17:00-18:00	(ALL)	(ALL)	1.60	10.00	15.97	0.00	0.00	0.00

Network Results

Network Results: Flows and signals

Time Segment	Calculated flow entering (Veh/hr)	Calculated flow out (Veh/hr)	Flow discrepancy (Veh/hr)	Adjusted flow warning	Degree of saturation (%)	DOS Threshold exceeded	Practical reserve capacity (%)	Actual green (s (per cycle))
17:00-18:00	5602	5602	0		88		14	1180

Network Results: Stops and delays

Time Segment	Mean Cruise Time per Veh (s)	Mean Delay per Veh (s)	Uniform delay (Veh-hr/hr)	Random plus oversat delay (Veh-hr/hr)	Weighted cost of delay (£ per hr)	Mean stops per Veh (%)	Uniform stops (Stops per hr)	Random stops (Stops per hr)	Weighted cost of stops (£ per hr)
17:00-18:00	13.08	22.04	26.71	7.59	487.04	31.86	1567.60	217.42	22.38

Network Results: Queues and blocking

Time Segment	Utilised storage (%)	Excess queue penalty (£ per hr)	Wasted time starvation (s (per cycle))	Wasted time blocking back (s (per cycle))	Wasted time total (s (per cycle))
17:00-18:00	433.32	0.00	155.00	188.00	343.00

Final Prediction Table

Traffic Stream Results

Arm	Traffic Stream	Name	Traffic node	SIGNALS		FLOWS		PERFORMANCE				PER PCU			QUEUES
				Controller stream	Phase	Calculated flow entering (Veh/hr)	Calculated sat flow (Veh/hr)	Actual green (s per cycle)	Wasted time total (s per cycle)	Degree of saturation (%)	Practical reserve capacity (%)	JourneyTime (s)	Mean Delay per Veh (s)	Mean stops per Veh (%)	Mean max queue (Veh)
A	1	(untitled)	1	1	D	383 <	1800	28	0.00	88	14	72.90	70.50	115.62	15.07 +
	2		1	1	C	109	1800	21	0.00	33	203	69.29	45.29	87.84	3.23
Ax	1	(untitled)				306	Unrestricted	120	34.00	0	Unrestricted	21.95	0.00	0.00	0.00
B	1	(untitled)	1	1	B	393	1800	32	0.00	79	26	77.77	53.77	101.95	13.58
	2		1	1	A	99 <	1800	9	0.00	66	52	77.72	75.56	113.33	3.80 +
Bx	1	(untitled)				596	Unrestricted	120	18.00	0	Unrestricted	21.41	0.00	0.00	0.00
C	1	(untitled)	1	1	D	168	1800	28	0.00	39	159	64.66	40.66	84.37	4.79
	2		1	1	C	280 <	1800	21	0.00	85	18	79.50	74.70	116.45	11.15 +
Cx	1	(untitled)				311	Unrestricted	120	58.00	0	Unrestricted	23.38	0.00	0.00	0.00
D	1	(untitled)	1	1	B	267	1800	32	0.00	54	85	65.26	41.26	87.05	7.88
	2		1	1	A	35	1800	9	7.00	23	329	58.68	55.08	95.35	1.12
Dx	1	(untitled)				521	Unrestricted	120	38.00	0	Unrestricted	21.24	0.00	0.00	0.00
9	1		1			492	Unrestricted	120	109.00	0	Unrestricted	5.82	0.00	0.00	0.00
10	1		1			492	Unrestricted	120	25.00	0	Unrestricted	3.78	0.00	0.00	0.00
11	1		1			448	Unrestricted	120	54.00	0	Unrestricted	4.44	0.00	0.00	0.00
12	1		1			302	Unrestricted	120	0.00	0	Unrestricted	4.12	0.00	0.00	0.00

Pedestrian Crossing Results

Pedestrian	Side	Name	Traffic node	SIGNALS		FLOWS		PERFORMANCE			PER PED		QUEUES	WEIGHTS	PEN
				Controller stream	Phase	Calculated Flow Entering (Ped/hr)	Calculated sat flow (Ped/hr)	Actual green (s per cycle)	Degree of saturation (%)	Practical reserve capacity (%)	JourneyTime (s)	Mean Delay per Ped (s)	Mean max queue (Ped)	Delay weighting (%)	Co tra pen (£ p
1	1	(untitled)	1	1	E	50	11000	5	11	817	61.25	55.58	1.60	100	0
	2	(untitled)	1	1	E	50	11000	5	11	817	61.25	55.58	1.60	100	0
2	1	(untitled)	1	1	E	50	11000	5	11	817	61.92	55.58	1.60	100	0
	2	(untitled)	1	1	E	50	11000	5	11	817	61.92	55.58	1.60	100	0
3	1	(untitled)	1	1	E	50	11000	5	11	817	61.92	55.58	1.60	100	0
	2	(untitled)	1	1	E	50	11000	5	11	817	61.92	55.58	1.60	100	0
4	1	(untitled)	1	1	E	50	11000	5	11	817	61.25	55.58	1.60	100	0
	2	(untitled)	1	1	E	50	11000	5	11	817	61.25	55.58	1.60	100	0

Network Results

	Distance travelled (PCU-km/hr)	Time spent (PCU-hr/hr)	Mean journey speed (kph)	Uniform delay (Veh-hr/hr)	Random plus oversat delay (Veh-hr/hr)	Weighted cost of delay (£ per hr)	Weighted cost of stops (£ per hr)	Excess queue penalty (£ per hr)	Performance Index (£ per hr)
Normal traffic	590.55	47.81	12.35	20.54	7.59	399.34	22.38	0.00	421.72
Bus	0.00	0.00	0.00	0.00	0.00	0.00	0.00	0.00	0.00
Tram	0.00	0.00	0.00	0.00	0.00	0.00	0.00	0.00	0.00
Pedestrians	3.40	6.84	0.50	6.18	0.00	87.70	0.00	0.00	87.70
TOTAL	593.95	54.65	10.87	26.71	7.59	487.04	22.38	0.00	509.42

- 1 < = adjusted flow warning (upstream links/traffic streams are over-saturated)
- 1 * = Traffic Stream - Normal, Bus or Tram Stop or Delay weighting has been set to a value other than 100%
- 1 ^ = Traffic Stream - Normal, Bus or Tram Stop or Delay Path weighting has been set to a value other than 100%
- 1 + = average link/traffic stream excess queue is greater than 0
- 1 P.I. = PERFORMANCE INDEX

A7 - DO SOMETHING 2039 D7 - DO SOMETHING 2039*

Summary

Data Errors and Warnings

No errors or warnings

Run Summary

Analysis set used	Run start time	Run finish time	Modelling start time (HH:mm)	Network Cycle Time (s)	Performance Index (£ per hr)	Total network delay (Veh-hr/hr)	Highest DOS (%)	Item with highest DOS	Number of oversaturated items	Percentage of oversaturated items (%)	Item with worst signalised PRC	Item with worst unsignalised PRC	Item with worst over PR
7	19/08/2020 12:06:39	19/08/2020 12:06:41	17:00	120	602.01	40.59	94.02	A/1	0	0	A/1	Dx/1	A/

Analysis Set Details

Name	Description	Demand set	Include in report	Locked
DO SOMETHING 2039		D7	✓	

Demand Set Details

Name	Description	Composite	Demand sets	Start time (HH:mm)	Locked
DO SOMETHING 2039				17:00	

Arms and Traffic Streams

Arms

Arm	Name	Description	Traffic node
A	(untitled)		1
Ax	(untitled)		
B	(untitled)		1
Bx	(untitled)		
C	(untitled)		1
Cx	(untitled)		
D	(untitled)		1
Dx	(untitled)		
9			1
10			1
11			1
12			1

Traffic Streams

Arm	Traffic Stream	Name	Description	Auto length	Length (m)	Has Saturation Flow	Saturation flow source	Saturation flow (PCU/hr)	Is signal controlled	Is give way	Traffic type	Allow Nearside Turn On Red
A	1	(untitled)			20.00	✓	Sum of lanes	1800	✓		Normal	
	2				200.00	✓	Sum of lanes	1800	✓		Normal	
Ax	1	(untitled)		✓	182.93						Normal	
B	1	(untitled)			200.00	✓	Sum of lanes	1800	✓		Normal	
	2				18.00	✓	Sum of lanes	1800	✓		Normal	
Bx	1	(untitled)		✓	178.44						Normal	
C	1	(untitled)			200.00	✓	Sum of lanes	1800	✓		Normal	
	2				40.00	✓	Sum of lanes	1800	✓		Normal	
Cx	1	(untitled)		✓	194.82						Normal	
D	1	(untitled)			200.00	✓	Sum of lanes	1800	✓		Normal	
	2				30.00	✓	Sum of lanes	1800	✓		Normal	
Dx	1	(untitled)		✓	177.04						Normal	
9	1			✓	48.53						Normal	
10	1			✓	31.46						Normal	
11	1			✓	37.01						Normal	
12	1			✓	34.36						Normal	

Lanes

Arm	Traffic Stream	Lane	Name	Description	Use RR67	Saturation flow (PCU/hr)
A	1	1	(untitled)			1800
	2	1	(untitled)			1800
Ax	1	1	(untitled)			
B	1	1	(untitled)			1800
	2	1	(untitled)			1800
Bx	1	1	(untitled)			
C	1	1	(untitled)			1800
	2	1	(untitled)			1800
Cx	1	1	(untitled)			
D	1	1	(untitled)			1800
	2	1	(untitled)			1800
Dx	1	1	(untitled)			
9	1	1	(untitled)			
10	1	1	(untitled)			
11	1	1	(untitled)			
12	1	1	(untitled)			

Modelling

Arm	Traffic Stream	Traffic model	Stop weighting multiplier (%)	Delay weighting multiplier (%)	Assignment Cost Weighting (%)	Exclude from results calculation	Max queue storage (PCU)	Has queue limit	Has degree of saturation limit
(ALL)	(ALL)	NetworkDefault	100	100	100		0.00		

Modelling - Advanced

Arm	Traffic Stream	Initial queue (PCU)	Type of Vehicle-in-Service	Vehicle-in-Service	Type of random parameter	Random parameter	Auto cycle time	Cycle time
(ALL)	(ALL)	0.00	NetworkDefault	Not-Included	NetworkDefault	0.50	✓	120

Normal traffic - Modelling

Arm	Traffic Stream	Stop weighting (%)	Delay weighting (%)
(ALL)	(ALL)	100	100

Normal traffic - Advanced

Arm	Traffic Stream	Dispersion type for Normal Traffic
(ALL)	(ALL)	NetworkDefault

Flows

Arm	Traffic Stream	Total Flow (Veh/hr)	Normal Flow (Veh/hr)
A	1	409	409
	2	117	117
Ax	1	326	326
B	1	424	424
	2	107	107
Bx	1	636	636
C	1	178	178
	2	297	297
Cx	1	332	332
D	1	286	286
	2	37	37
Dx	1	561	561
9	1	526	526
10	1	531	531
11	1	475	475
12	1	323	323

Signals

Arm	Traffic Stream	Controller stream	Phase	Second phase enabled
A	1	1	D	
	2	1	C	
B	1	1	B	
	2	1	A	
C	1	1	D	
	2	1	C	
D	1	1	B	
	2	1	A	

Pedestrian Crossings

Pedestrian Crossings

Crossing	Name	Description	Traffic node	Allow walk on red	Crossing type	Length (m)	Cruise time (seconds)	Cruise speed (kph)
1	(untitled)		1		Farside	7.00	4.67	5.40
2	(untitled)		1		Farside	8.00	5.33	5.40
3	(untitled)		1		Farside	8.00	5.33	5.40
4	(untitled)		1		Farside	7.00	4.67	5.40

Pedestrian Crossings - Signals

Crossing	Controller stream	Phase	Second phase enabled
(ALL)	1	E	

Pedestrian Crossings - Sides

Crossing	Side	Saturation flow (Ped/hr)
(ALL)	(ALL)	11000

Pedestrian Crossings - Modelling

Crossing	Side	Delay weighting (%)	Assignment Cost Weighting (%)	Exclude from results calculation	Max queue storage (Ped)	Has queue limit	Has degree of saturation limit
(ALL)	(ALL)	100	100		0.00		

Local OD Matrix - Local Matrix: 1

Local Matrix Options

OD Matrix	Name	Use for point to point table	Auto calculate	Allocation mode	Allow paths past exit locations	Allow looped paths on arms	Allow looped paths on traffic nodes	Copy flows	Matrix to copy flows from	Limit paths by length	Path length limit multiplier	Limit paths by number	Path number limit
1	(untitled)	✓	✓	Path Equalisation	✓		✓			✓	1.25		

Normal Input Flows (Veh/hr)

	To							
	1	2	3	4	5	6	7	8
From 1	0	23	155	297	0	0	0	0
From 2	37	0	64	222	0	0	0	0
From 3	292	117	0	117	0	0	0	0
From 4	3	421	107	0	0	0	0	0
From 5	0	0	0	0	0	0	0	0
From 6	0	0	0	0	0	0	0	0
From 7	0	0	0	0	0	0	0	0
From 8	0	0	0	0	0	0	0	0

Bus Input Flows not shown as they are blank.

Tram Input Flows not shown as they are blank.

Pedestrian Input Flows (Veh/hr)

	To							
	1	2	3	4	5	6	7	8
From 1	0	0	0	0	0	0	0	0
From 2	0	0	0	0	0	0	0	0
From 3	0	0	0	0	0	0	0	0
From 4	0	0	0	0	0	0	0	0
From 5	0	0	0	0	0	50	50	0
From 6	0	0	0	0	50	0	0	50
From 7	0	0	0	0	50	0	0	50
From 8	0	0	0	0	0	50	50	0

Locations

OD Matrix	Location	Name	Entries	Exits	Colour
1	1	(untitled)	11/1	Cx/1	#0000FF
	2	(untitled)	12/1	Dx/1	#FF0000
	3	(untitled)	9/1	Ax/1	#00FF00
	4	(untitled)	10/1	Bx/1	#FFFF00
	5	(untitled)	3:2E, 1:1E	3:2X, 1:1X	#FF00FF
	6	(untitled)	2:1E, 1:2E	2:1X, 1:2X	#008000
	7	(untitled)	4:2E, 3:1E	4:2X, 3:1X	#FFA500
	8	(untitled)	4:1E, 2:2E	4:1X, 2:2X	#00FFFF

Normal Paths and Flows

OD Matrix	Path	Description	From location	To location	Path items	Allocation type	Normal Calculated Flow (Veh/hr)
1	9		4	3	10/1, B/2, Ax/1	Normal	107
	10		3	4	9/1, A/1, Bx/1	Normal	117
	11		1	3	11/1, C/1, Ax/1	Normal	155
	12		1	4	11/1, C/2, Bx/1	Normal	297
	13		3	1	9/1, A/1, Cx/1	Normal	292
	14		4	1	10/1, B/1, Cx/1	Normal	3
	15		2	3	12/1, D/1, Ax/1	Normal	64
	16		2	4	12/1, D/1, Bx/1	Normal	222
	19		3	2	9/1, A/2, Dx/1	Normal	117
	20		4	2	10/1, B/1, Dx/1	Normal	421
	43		2	1	12/1, D/2, Cx/1	Normal	37
	44		1	2	11/1, C/1, Dx/1	Normal	23

Pedestrian Paths and Flows

OD Matrix	Path	Description	From location	To location	Path items	Allocation type	Pedestrian calculated flow (Ped/hr)
1	17		8	7	4:1E, 4:2X	Normal	50
	18		8	6	2:2E, 2:1X	Normal	50
	22		5	7	3:2E, 3:1X	Normal	50
	23		5	6	1:1E, 1:2X	Normal	50
	34		6	8	2:1E, 2:2X	Normal	50
	35		6	5	1:2E, 1:1X	Normal	50
	41		7	8	4:2E, 4:1X	Normal	50
	42		7	5	3:1E, 3:2X	Normal	50

Signal Timings

Network Default: 120s cycle time; 120 steps

Controller Stream 1

Controller Stream	Name	Description	Use sequence	Cycle time source	Cycle time (s)
1	(untitled)		1	NetworkDefault	120

Controller Stream 1 - Properties

Controller Stream	Manufacturer name	Type	Model number	(Telephone) Line Number	Site number	Grid reference	Gaining delay type
1	Unspecified						Relative

Controller Stream 1 - Optimisation

Controller Stream	Allow offset optimisation	Allow green split optimisation	Optimisation level	Auto redistribute	Enable stage constraint
1	✓	✓	Offsets And Green Splits	✓	

Phases

Controller Stream	Phase	Name	Minimum green (s)	Maximum green (s)	Relative start displacement (s)	Relative end displacement (s)	Type	Blackout Time (s)
1	A	(untitled)	7	70	0	0	Traffic	
	B	(untitled)	7	70	0	0	Traffic	
	C	(untitled)	7	70	0	0	Traffic	
	D	(untitled)	7	70	0	0	Traffic	
	E	(untitled)	5	5	0	0	Pedestrian	0

Library Stages

Controller Stream	Library Stage	Phases in stage	User stage minimum (s)
1	1	A	1
	2	B	1
	3	C	1
	4	D	1
	5	E	1

Stage Sequences

Controller Stream	Sequence	Name	Multiple cycling	Stage IDs	Stage ends
1	1	(untitled)	Single	1, 2, 3, 4, 5	0, 37, 63, 96, 106

Intergreen Matrix for Controller Stream 1

		To				
		A	B	C	D	E
From	A		5	5	5	5
	B	5		5	5	5
	C	5	5		5	5
	D	5	5	5		5
	E	5	5	5	5	

Banned Stage transitions for Controller Stream 1

		To				
		1	2	3	4	5
From	1					
	2					
	3					
	4					
	5					

Interstage Matrix for Controller Stream 1

		To				
		1	2	3	4	5
From	1	0	5	5	5	5
	2	5	0	5	5	5
	3	5	5	0	5	5
	4	5	5	5	0	5
	5	5	5	5	5	0

Resultant Stages

Controller Stream	Resultant Stage	Is base stage	Library Stage ID	Phases in this stage	Stage start (s)	Stage end (s)	Stage duration (s)	User stage minimum (s)	Stage minimum (s)
1	1	✓	1	A	111	0	9	1	7
	2	✓	2	B	5	37	32	1	7
	3	✓	3	C	42	63	21	1	7
	4	✓	4	D	68	96	28	1	7
	5	✓	5	E	101	106	5	1	5

Resultant Phase Green Periods

Controller Stream	Phase	Green period	Is base green period	Start time (s)	End time (s)	Duration (s)
1	A	1	✓	111	0	9
	B	1	✓	5	37	32
	C	1	✓	42	63	21
	D	1	✓	68	96	28
	E	1	✓	101	106	5

Traffic Stream Green Times

Arm	Traffic Stream	Traffic Node	Controller Stream	Phase	Green Period 1		
					Start	End	Duration
A	1	1	1	D	68	96	28
A	2	1	1	C	42	63	21
B	1	1	1	B	5	37	32
B	2	1	1	A	111	0	9
C	1	1	1	D	68	96	28
C	2	1	1	C	42	63	21
D	1	1	1	B	5	37	32
D	2	1	1	A	111	0	9

Phase Timings Diagram for Controller Stream 1

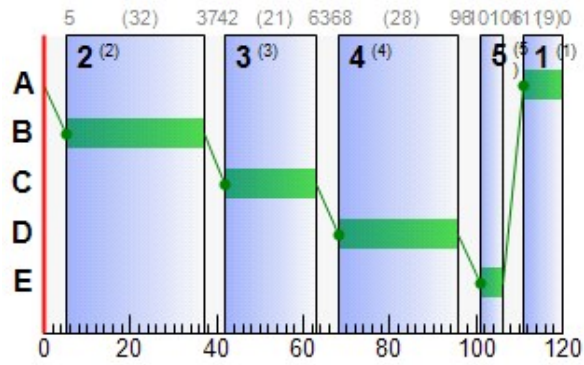

Stage Sequence Diagram for Controller Stream 1

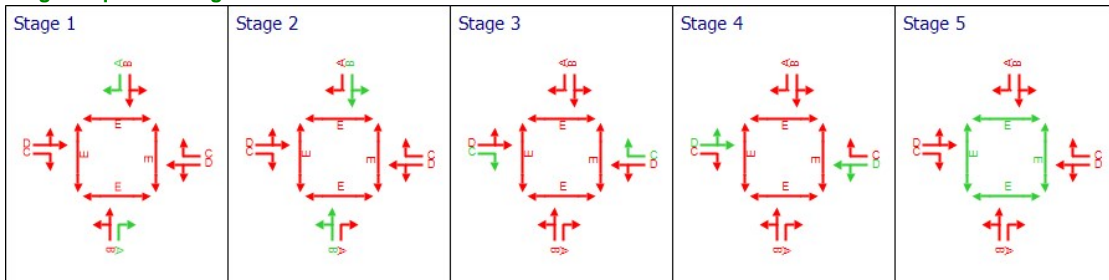

Resultant penalties

Time Segment	Controller stream	Phase min max penalty (£ per hr)	Intergreen broken penalty (£ per hr)	Stage constraint broken penalty (£ per hr)	Cost of controller stream penalties (£ per hr)
17:00-18:00	1	0.00	0.00	0.00	0.00

Traffic Stream Results

Traffic Stream Results: Vehicle summary

Time Segment	Arm	Traffic Stream	Degree of saturation (%)	Practical reserve capacity (%)	Calculated flow entering (Veh/hr)	Calculated sat flow (Veh/hr)	Actual green (s per cycle)	Mean Delay per Veh (s)	Mean max queue (Veh)	Utilised storage (%)	Weighted cost of delay (£ per hr)	Weighted cost of stops (£ per hr)	Performance Index (£ per hr)	
17:00-18:00	A	1	94	6	409	1800	28	89.21	18.35	527.70	143.92	6.68	150.60	
		2	35	182	117	1800	21	45.79	3.48	10.00	21.13	1.29	22.43	
	Ax	1	0	Unrestricted	326	Unrestricted	120	0.00	0.00	0.00	0.00	0.00	0.00	0.00
		2	0	Unrestricted	326	Unrestricted	120	0.00	0.00	0.00	0.00	0.00	0.00	0.00
	B	1	86	17	424	1800	32	61.18	15.66	45.01	102.32	5.79	108.11	
		2	71	40	107	1800	9	81.48	4.28	136.60	34.39	1.58	35.96	
	Bx	1	0	Unrestricted	636	Unrestricted	120	0.00	0.00	0.00	0.00	0.00	0.00	0.00
		2	0	Unrestricted	636	Unrestricted	120	0.00	0.00	0.00	0.00	0.00	0.00	0.00
	C	1	41	144	178	1800	28	41.14	5.09	14.62	28.89	1.89	30.78	
		2	90	11	297	1800	21	87.19	12.89	185.32	102.15	4.71	106.85	
	Cx	1	0	Unrestricted	332	Unrestricted	120	0.00	0.00	0.00	0.00	0.00	0.00	0.00
		2	0	Unrestricted	332	Unrestricted	120	0.00	0.00	0.00	0.00	0.00	0.00	0.00
	D	1	58	73	286	1800	32	42.43	8.57	24.65	47.87	3.18	51.05	
		2	25	305	37	1800	9	55.43	1.19	22.83	8.09	0.44	8.53	
Dx	1	0	Unrestricted	561	Unrestricted	120	0.00	0.00	0.00	0.00	0.00	0.00	0.00	
	2	0	Unrestricted	561	Unrestricted	120	0.00	0.00	0.00	0.00	0.00	0.00	0.00	
9	1	0	Unrestricted	526	Unrestricted	120	0.00	0.00	0.00	0.00	0.00	0.00	0.00	
10	1	0	Unrestricted	531	Unrestricted	120	0.00	0.00	0.00	0.00	0.00	0.00	0.00	
11	1	0	Unrestricted	475	Unrestricted	120	0.00	0.00	0.00	0.00	0.00	0.00	0.00	
12	1	0	Unrestricted	323	Unrestricted	120	0.00	0.00	0.00	0.00	0.00	0.00	0.00	

Traffic Stream Results: Flows and signals

Time Segment	Arm	Traffic Stream	Calculated flow entering (Veh/hr)	Calculated flow out (Veh/hr)	Flow discrepancy (Veh/hr)	Adjusted flow warning	Calculated sat flow (Veh/hr)	Calculated capacity (Veh/hr)	Degree of saturation (%)	DOS Threshold exceeded	Practical reserve capacity (%)	Mean modulus of error	Actual green (s per cycle)
17:00-18:00	A	1	409	409	0		1800	435	94		6	0.00	28
		2	117	117	0		1800	330	35		182	0.00	21
	Ax	1	326	326	0		Unrestricted	Unrestricted	0		Unrestricted	0.80	120
		2	326	326	0		Unrestricted	Unrestricted	0		Unrestricted	0.80	120
	B	1	424	424	0		1800	495	86		17	0.00	32
		2	107	107	0		1800	150	71		40	0.00	9
	Bx	1	636	636	0		Unrestricted	Unrestricted	0		Unrestricted	0.61	120
		2	636	636	0		Unrestricted	Unrestricted	0		Unrestricted	0.61	120
	C	1	178	178	0		1800	435	41		144	0.00	28
		2	297	297	0		1800	330	90		11	0.00	21
	Cx	1	332	332	0		Unrestricted	Unrestricted	0		Unrestricted	1.08	120
		2	332	332	0		Unrestricted	Unrestricted	0		Unrestricted	1.08	120
	D	1	286	286	0		1800	495	58		73	0.00	32
		2	37	37	0		1800	150	25		305	0.00	9
Dx	1	561	561	0		Unrestricted	Unrestricted	0		Unrestricted	0.96	120	
	2	561	561	0		Unrestricted	Unrestricted	0		Unrestricted	0.96	120	
9	1	526	526	0		Unrestricted	Unrestricted	0		Unrestricted	0.00	120	
10	1	531	531	0		Unrestricted	Unrestricted	0		Unrestricted	0.00	120	
11	1	475	475	0		Unrestricted	Unrestricted	0		Unrestricted	0.00	120	
12	1	323	323	0		Unrestricted	Unrestricted	0		Unrestricted	0.00	120	

Traffic Stream Results: Stops and delays

Time Segment	Arm	Traffic Stream	Mean Cruise Time per Veh (s)	Mean Delay per Veh (s)	Uniform delay (Veh-hr/hr)	Random plus oversat delay (Veh-hr/hr)	Weighted cost of delay (£ per hr)	Mean stops per Veh (%)	Uniform stops (Stops per hr)	Random stops (Stops per hr)	Weighted cost of stops (£ per hr)	
17:00-18:00	A	1	2.40	89.21	5.07	5.06	143.92	130.18	393.82	138.61	6.68	
		2	24.00	45.79	1.39	0.10	21.13	88.15	100.25	2.89	1.29	
	Ax	1	21.95	0.00	0.00	0.00	0.00	0.00	0.00	0.00	0.00	0.00
		2	24.00	61.18	4.86	2.35	102.32	108.89	394.14	67.55	5.79	
	B	1	24.00	61.18	4.86	2.35	102.32	108.89	394.14	67.55	5.79	
		2	2.16	81.48	1.59	0.83	34.39	117.61	102.38	23.46	1.58	
	Bx	1	21.41	0.00	0.00	0.00	0.00	0.00	0.00	0.00	0.00	0.00
		2	24.00	41.14	1.89	0.14	28.89	84.71	146.58	4.21	1.89	
	C	1	24.00	41.14	1.89	0.14	28.89	84.71	146.58	4.21	1.89	
		2	4.80	87.19	3.95	3.24	102.15	126.42	285.82	89.65	4.71	
	Cx	1	23.38	0.00	0.00	0.00	0.00	0.00	0.00	0.00	0.00	0.00
		2	24.00	42.43	2.98	0.39	47.87	88.69	242.02	11.63	3.18	
	D	1	24.00	42.43	2.98	0.39	47.87	88.69	242.02	11.63	3.18	
		2	3.60	55.43	0.53	0.04	8.09	95.58	34.17	1.20	0.44	
Dx	1	21.24	0.00	0.00	0.00	0.00	0.00	0.00	0.00	0.00	0.00	
	2	5.82	0.00	0.00	0.00	0.00	0.00	0.00	0.00	0.00	0.00	
9	1	5.82	0.00	0.00	0.00	0.00	0.00	0.00	0.00	0.00	0.00	
10	1	3.78	0.00	0.00	0.00	0.00	0.00	0.00	0.00	0.00	0.00	
11	1	4.44	0.00	0.00	0.00	0.00	0.00	0.00	0.00	0.00	0.00	
12	1	4.12	0.00	0.00	0.00	0.00	0.00	0.00	0.00	0.00	0.00	

Traffic Stream Results: Queues and blocking

Time Segment	Arm	Traffic Stream	Initial queue (Veh)	mean max queue (Veh)	max queue storage (Veh)	Utilised storage (%)	storage excess queue (Veh)	limit excess queue (Veh)	Excess queue penalty (£ per hr)	Wasted time starvation (s per cycle)	wasted time blocking back (s per cycle)	wasted time total (s per cycle)	Estimated blocking	
17:00-18:00	A	1	0.00	18.35	3.48	527.70	8.12	0.00	0.00	0.00	0.00	0.00		
		2	0.00	3.48	34.78	10.00	0.00	0.00	0.00	0.00	0.00	0.00		
	Ax	1	0.00	0.00	31.81	0.00	0.00	0.00	0.00	0.00	34.00	0.00	34.00	
		2	0.00	15.66	34.78	45.01	0.00	0.00	0.00	0.00	0.00	0.00	0.00	
	B	1	0.00	15.66	34.78	45.01	0.00	0.00	0.00	0.00	0.00	0.00	0.00	
		2	0.00	4.28	3.13	136.60	0.19	0.00	0.00	0.00	0.00	0.00	0.00	
	Bx	1	0.00	0.00	31.03	0.00	0.00	0.00	0.00	0.00	16.00	0.00	16.00	
		2	0.00	5.09	34.78	14.62	0.00	0.00	0.00	0.00	0.00	0.00	0.00	
	C	1	0.00	5.09	34.78	14.62	0.00	0.00	0.00	0.00	0.00	0.00	0.00	
		2	0.00	12.89	6.96	185.32	1.80	0.00	0.00	0.00	0.00	0.00	0.00	
	Cx	1	0.00	0.00	33.88	0.00	0.00	0.00	0.00	0.00	57.00	0.00	57.00	
		2	0.00	8.57	34.78	24.65	0.00	0.00	0.00	0.00	0.00	0.00	0.00	
	D	1	0.00	8.57	34.78	24.65	0.00	0.00	0.00	0.00	0.00	0.00	0.00	
		2	0.00	1.19	5.22	22.83	0.00	0.00	0.00	0.00	7.00	0.00	7.00	
Dx	1	0.00	0.00	30.79	0.00	0.00	0.00	0.00	0.00	37.00	0.00	37.00		
	2	0.00	0.00	8.44	0.00	0.00	0.00	0.00	0.00	0.00	120.00	120.00		
9	1	0.00	0.00	8.44	0.00	0.00	0.00	0.00	0.00	0.00	120.00	120.00		
10	1	0.00	0.00	5.47	0.00	0.00	0.00	0.00	0.00	0.00	39.00	39.00		
11	1	0.00	0.00	6.44	0.00	0.00	0.00	0.00	0.00	0.00	72.00	72.00		
12	1	0.00	0.00	5.97	0.00	0.00	0.00	0.00	0.00	0.00	0.00	0.00		

Pedestrian Crossing Results

Pedestrian Crossings: Pedestrian summary

Time Segment	Crossing	Side	Degree of saturation (%)	Calculated Flow Entering (Ped/hr)	Calculated sat flow (Ped/hr)	Actual green (s per cycle)	Mean Delay Per Ped (s)	Mean max queue (Ped)	Weighted cost of delay (£ per hr)	Performance Index (£ per hr)
17:00-18:00	(ALL)	(ALL)	11	50	11000	5	55.58	1.60	10.96	10.96

Pedestrian Crossings: Flows and signals

Time Segment	Crossing	Side	Calculated flow entering (Ped/hr)	Calculated flow out (Ped/hr)	Flow discrepancy (Ped/hr)	Adjusted flow warning	Calculated sat flow (Ped/hr)	Calculated capacity (Ped/hr)	Degree of saturation (%)	DOS Threshold exceeded	Practical reserve capacity (%)	Mean modulus of error	Actual green (s per cycle)
17:00-18:00	(ALL)	(ALL)	50	50	0		11000	458	11		817	0.00	5

Pedestrian Crossings: Stops and delays

Time Segment	Crossing	Side	Mean Cruise Time per Ped (s)	Mean Delay per Ped (s)	Uniform delay (Ped-hr/hr)	Random plus oversat delay (Ped-hr/hr)	Weighted cost of delay (£ per hr)
17:00-18:00	1	1	5.67	55.58	0.77	0.00	10.96
		2	5.67	55.58	0.77	0.00	10.96
	2	1	6.33	55.58	0.77	0.00	10.96
		2	6.33	55.58	0.77	0.00	10.96
	3	1	6.33	55.58	0.77	0.00	10.96
		2	6.33	55.58	0.77	0.00	10.96
	4	1	5.67	55.58	0.77	0.00	10.96
		2	5.67	55.58	0.77	0.00	10.96

Pedestrian Crossings: Queues and blocking

Time Segment	Crossing	Side	Mean max queue (Ped)	Max queue storage (Ped)	Utilised storage (%)	Average storage excess queue (Ped)	Average limit excess queue (Ped)	Excess queue penalty (£ per hr)
17:00-18:00	(ALL)	(ALL)	1.60	10.00	15.97	0.00	0.00	0.00

Network Results

Network Results: Flows and signals

Time Segment	Calculated flow entering (Veh/hr)	Calculated flow out (Veh/hr)	Flow discrepancy (Veh/hr)	Adjusted flow warning	Degree of saturation (%)	DOS Threshold exceeded	Practical reserve capacity (%)	Actual green (s (per cycle))
17:00-18:00	5965	5965	0		94		6	1180

Network Results: Stops and delays

Time Segment	Mean Cruise Time per Veh (s)	Mean Delay per Veh (s)	Uniform delay (Veh-hr/hr)	Random plus oversat delay (Veh-hr/hr)	Weighted cost of delay (£ per hr)	Mean stops per Veh (%)	Uniform stops (Stops per hr)	Random stops (Stops per hr)	Weighted cost of stops (£ per hr)
17:00-18:00	13.12	24.50	28.45	12.15	576.45	34.17	1699.18	339.18	25.56

Network Results: Queues and blocking

Time Segment	Utilised storage (%)	Excess queue penalty (£ per hr)	Wasted time starvation (s (per cycle))	Wasted time blocking back (s (per cycle))	Wasted time total (s (per cycle))
17:00-18:00	527.70	0.00	151.00	231.00	382.00

Final Prediction Table

Traffic Stream Results

Arm	Traffic Stream	Name	Traffic node	SIGNALS		FLOWS		PERFORMANCE				PER PCU			QUEUES
				Controller stream	Phase	Calculated flow entering (Veh/hr)	Calculated sat flow (Veh/hr)	Actual green (s per cycle)	Wasted time total (s per cycle)	Degree of saturation (%)	Practical reserve capacity (%)	JourneyTime (s)	Mean Delay per Veh (s)	Mean stops per Veh (%)	Mean max queue (Veh)
A	1	(untitled)	1	1	D	409 <	1800	28	0.00	94	6	91.61	89.21	130.18	18.35 +
	2		1	1	C	117	1800	21	0.00	35	182	69.79	45.79	88.15	3.48
Ax	1	(untitled)				326	Unrestricted	120	34.00	0	Unrestricted	21.95	0.00	0.00	0.00
B	1	(untitled)	1	1	B	424	1800	32	0.00	86	17	85.18	61.18	108.89	15.66
	2		1	1	A	107 <	1800	9	0.00	71	40	83.64	81.48	117.61	4.28 +
Bx	1	(untitled)				636	Unrestricted	120	16.00	0	Unrestricted	21.41	0.00	0.00	0.00
C	1	(untitled)	1	1	D	178	1800	28	0.00	41	144	65.14	41.14	84.71	5.09
	2		1	1	C	297 <	1800	21	0.00	90	11	91.99	87.19	126.42	12.89 +
Cx	1	(untitled)				332	Unrestricted	120	57.00	0	Unrestricted	23.38	0.00	0.00	0.00
D	1	(untitled)	1	1	B	286	1800	32	0.00	58	73	66.43	42.43	88.69	8.57
	2		1	1	A	37	1800	9	7.00	25	305	59.03	55.43	95.58	1.19
Dx	1	(untitled)				561	Unrestricted	120	37.00	0	Unrestricted	21.24	0.00	0.00	0.00
9	1		1			526	Unrestricted	120	120.00	0	Unrestricted	5.82	0.00	0.00	0.00
10	1		1			531	Unrestricted	120	39.00	0	Unrestricted	3.78	0.00	0.00	0.00
11	1		1			475	Unrestricted	120	72.00	0	Unrestricted	4.44	0.00	0.00	0.00
12	1		1			323	Unrestricted	120	0.00	0	Unrestricted	4.12	0.00	0.00	0.00

Pedestrian Crossing Results

Pedestrian	Side	Name	Traffic node	SIGNALS		FLOWS		PERFORMANCE			PER PED		QUEUES	WEIGHTS	PEN
				Controller stream	Phase	Calculated Flow Entering (Ped/hr)	Calculated sat flow (Ped/hr)	Actual green (s per cycle)	Degree of saturation (%)	Practical reserve capacity (%)	JourneyTime (s)	Mean Delay per Ped (s)	Mean max queue (Ped)	Delay weighting (%)	Co tra pen (£ p
1	1	(untitled)	1	1	E	50	11000	5	11	817	61.25	55.58	1.60	100	0
	2	(untitled)	1	1	E	50	11000	5	11	817	61.25	55.58	1.60	100	0
2	1	(untitled)	1	1	E	50	11000	5	11	817	61.92	55.58	1.60	100	0
	2	(untitled)	1	1	E	50	11000	5	11	817	61.92	55.58	1.60	100	0
3	1	(untitled)	1	1	E	50	11000	5	11	817	61.92	55.58	1.60	100	0
	2	(untitled)	1	1	E	50	11000	5	11	817	61.92	55.58	1.60	100	0
4	1	(untitled)	1	1	E	50	11000	5	11	817	61.25	55.58	1.60	100	0
	2	(untitled)	1	1	E	50	11000	5	11	817	61.25	55.58	1.60	100	0

Network Results

	Distance travelled (PCU-km/hr)	Time spent (PCU-hr/hr)	Mean journey speed (kph)	Uniform delay (Veh-hr/hr)	Random plus oversat delay (Veh-hr/hr)	Weighted cost of delay (£ per hr)	Weighted cost of stops (£ per hr)	Excess queue penalty (£ per hr)	Performance Index (£ per hr)
Normal traffic	632.12	55.49	11.39	22.27	12.15	488.75	25.56	0.00	514.31
Bus	0.00	0.00	0.00	0.00	0.00	0.00	0.00	0.00	0.00
Tram	0.00	0.00	0.00	0.00	0.00	0.00	0.00	0.00	0.00
Pedestrians	3.40	6.84	0.50	6.18	0.00	87.70	0.00	0.00	87.70
TOTAL	635.52	62.33	10.20	28.45	12.15	576.45	25.56	0.00	602.01

- 1 < = adjusted flow warning (upstream links/traffic streams are over-saturated)
- 1 * = Traffic Stream - Normal, Bus or Tram Stop or Delay weighting has been set to a value other than 100%
- 1 ^ = Traffic Stream - Normal, Bus or Tram Stop or Delay Path weighting has been set to a value other than 100%
- 1 + = average link/traffic stream excess queue is greater than 0
- 1 P.I. = PERFORMANCE INDEX



<h1>Junctions 9</h1>
<h2>PICADY 9 - Priority Intersection Module</h2>
Version: 9.5.1.7462 © Copyright TRL Limited, 2019
For sales and distribution information, program advice and maintenance, contact TRL: +44 (0)1344 379777 software@trl.co.uk www.trlsoftware.co.uk
The users of this computer program for the solution of an engineering problem are in no way relieved of their responsibility for the correctness of the solution

Filename: Junction 2 - AM-PM.j9

Path: M:\Projects\12\12-081A - Dunshaughlin Phase 2 - Civils\Design\Traffic\Modelling AUGUST 2020\Junction 2

Report generation date: 19/08/2020 12:09:03

-
- »JUNCTION 2 - DO NOTHING 2020, AM
 - »JUNCTION 2 - DO NOTHING 2020, PM
 - »JUNCTION 2 - DO NOTHING 2024, AM
 - »JUNCTION 2 - DO NOTHING 2024, PM
 - »JUNCTION 2 - DO NOTHING 2029, AM
 - »JUNCTION 2 - DO NOTHING 2029, PM
 - »JUNCTION 2 - DO NOTHING 2039, AM
 - »JUNCTION 2 - DO NOTHING 2039, PM
 - »JUNCTION 2 - DO SOMETHING 2024, AM
 - »JUNCTION 2 - DO SOMETHING 2024, PM
 - »JUNCTION 2 - DO SOMETHING 2029, AM
 - »JUNCTION 2 - DO SOMETHING 2029, PM
 - »JUNCTION 2 - DO SOMETHING 2039, AM
 - »JUNCTION 2 - DO SOMETHING 2039, PM

Summary of junction performance

	AM					PM				
	Set ID	Queue (Veh)	Delay (s)	RFC	LOS	Set ID	Queue (Veh)	Delay (s)	RFC	LOS
JUNCTION 2 - DO NOTHING 2020										
Stream B-ACD	D1	0.1	10.82	0.12	B	D2	0.7	17.64	0.43	C
Stream A-D		0.2	8.86	0.17	A		0.3	9.01	0.24	A
Stream D-ABC		0.7	13.57	0.41	B		0.5	12.16	0.35	B
Stream C-ABD		0.2	4.30	0.10	A		0.5	6.45	0.23	A
JUNCTION 2 - DO NOTHING 2024										
Stream B-ACD	D3	0.2	11.54	0.14	B	D4	0.9	20.68	0.48	C
Stream A-D		0.2	9.33	0.18	A		0.3	9.46	0.26	A
Stream D-ABC		0.8	15.31	0.46	C		0.6	13.46	0.39	B
Stream C-ABD		0.3	4.23	0.12	A		0.7	6.61	0.27	A
JUNCTION 2 - DO NOTHING 2029										
Stream B-ACD	D5	0.2	12.78	0.16	B	D6	1.4	28.10	0.59	D
Stream A-D		0.3	9.95	0.21	A		0.4	10.28	0.29	B
Stream D-ABC		1.1	18.78	0.53	C		0.9	16.68	0.47	C
Stream C-ABD		0.4	4.18	0.14	A		1.0	6.81	0.32	A
JUNCTION 2 - DO NOTHING 2039										
Stream B-ACD	D7	0.2	13.77	0.18	B	D8	2.1	38.37	0.68	E
Stream A-D		0.3	10.52	0.23	B		0.5	10.89	0.32	B
Stream D-ABC		1.4	22.50	0.59	C		1.1	19.46	0.52	C
Stream C-ABD		0.5	4.16	0.16	A		1.2	7.17	0.37	A
JUNCTION 2 - DO SOMETHING 2024										
Stream B-ACD	D9	0.2	11.86	0.14	B	D10	1.0	21.62	0.50	C
Stream A-D		0.2	9.54	0.19	A		0.3	9.55	0.26	A
Stream D-ABC		0.9	16.07	0.47	C		0.7	13.82	0.40	B
Stream C-ABD		0.3	4.15	0.13	A		0.7	6.60	0.27	A
JUNCTION 2 - DO SOMETHING 2029										
Stream B-ACD	D11	0.2	13.18	0.17	B	D12	1.5	30.00	0.60	D
Stream A-D		0.3	10.19	0.21	B		0.4	10.39	0.29	B
Stream D-ABC		1.2	19.93	0.55	C		0.9	17.28	0.48	C
Stream C-ABD		0.4	4.11	0.15	A		1.0	6.83	0.33	A
JUNCTION 2 - DO SOMETHING 2039										
Stream B-ACD	D13	0.2	14.27	0.19	B	D14	2.3	42.06	0.70	E
Stream A-D		0.3	10.79	0.23	B		0.5	11.01	0.32	B
Stream D-ABC		1.5	24.27	0.61	C		1.1	20.32	0.53	C
Stream C-ABD		0.5	4.10	0.17	A		1.3	7.21	0.38	A

Values shown are the highest values encountered over all time segments. Delay is the maximum value of average delay per arriving vehicle.

File summary

File Description

Title	
Location	
Site number	
Date	04/03/2020
Version	
Status	(new file)
Identifier	
Client	
Jobnumber	
Enumerator	DOMAINf.silva
Description	

Units

Distance units	Speed units	Traffic units input	Traffic units results	Flow units	Average delay units	Total delay units	Rate of delay units
m	kph	Veh	Veh	perHour	s	-Min	perMin

Analysis Options

Calculate Queue Percentiles	Calculate residual capacity	RFC Threshold	Average Delay threshold (s)	Queue threshold (PCU)
		0.85	36.00	20.00

Demand Set Summary

ID	Scenario name	Time Period name	Traffic profile type	Start time (HH:mm)	Finish time (HH:mm)	Time segment length (min)	Single time segment only
D1	DO NOTHING 2020	AM	FLAT	08:00	09:00	60	✓
D2	DO NOTHING 2020	PM	FLAT	17:00	18:00	60	✓
D3	DO NOTHING 2024	AM	FLAT	08:00	09:00	60	✓
D4	DO NOTHING 2024	PM	FLAT	17:00	18:00	60	✓
D5	DO NOTHING 2029	AM	FLAT	08:00	09:00	60	✓
D6	DO NOTHING 2029	PM	FLAT	17:00	18:00	60	✓
D7	DO NOTHING 2039	AM	FLAT	08:00	09:00	60	✓
D8	DO NOTHING 2039	PM	FLAT	17:00	18:00	60	✓
D9	DO SOMETHING 2024	AM	FLAT	08:00	09:00	60	✓
D10	DO SOMETHING 2024	PM	FLAT	17:00	18:00	60	✓
D11	DO SOMETHING 2029	AM	FLAT	08:00	09:00	60	✓
D12	DO SOMETHING 2029	PM	FLAT	17:00	18:00	60	✓
D13	DO SOMETHING 2039	AM	FLAT	08:00	09:00	60	✓
D14	DO SOMETHING 2039	PM	FLAT	17:00	18:00	60	✓

Analysis Set Details

ID	Name	Network flow scaling factor (%)
A1	JUNCTION 2	100.000

JUNCTION 2 - DO NOTHING 2020, AM

Data Errors and Warnings

No errors or warnings

Junction Network

Junctions

Junction	Name	Junction type	Major road direction	Use circulating lanes	Junction Delay (s)	Junction LOS
1	untitled	Crossroads	Two-way		3.12	A

Junction Network Options

Driving side	Lighting
Left	Normal/unknown

Arms

Arms

Arm	Name	Description	Arm type
A	R147 (S)		Major
B	Minor Western Arm		Minor
C	R147 (N)		Major
D	Lagore Road (E)		Minor

Major Arm Geometry

Arm	Width of carriageway (m)	Has kerbed central reserve	Has right turn bay	Width for right turn (m)	Visibility for right turn (m)	Blocks?	Blocking queue (PCU)
A	8.60		✓	2.40	75.0		-
C	8.60				100.0	✓	0.00

Geometries for Arm C are measured opposite Arm B. Geometries for Arm A (if relevant) are measured opposite Arm D.

Minor Arm Geometry

Arm	Minor arm type	Lane width (m)	Visibility to left (m)	Visibility to right (m)
B	One lane	2.20	55	55
D	One lane	3.00	50	75

Slope / Intercept / Capacity

Priority Intersection Slopes and Intercepts

Stream	Intercept (Veh/hr)	Slope for A-B	Slope for A-C	Slope for A-D	Slope for B-A	Slope for B-C	Slope for B-D	Slope for C-A	Slope for C-B	Slope for C-D	Slope for D-A	Slope for D-B	Slope for D-C
A-D	631	-	-	-	-	-	-	0.217	0.310	0.217	-	-	-
B-A	481	0.078	0.196	0.196	-	-	-	0.124	0.280	-	0.196	0.196	0.098
B-C	606	0.082	0.208	-	-	-	-	-	-	-	-	-	-
B-D, nearside lane	481	0.078	0.196	0.196	-	-	-	0.124	0.280	0.124	-	-	-
B-D, offside lane	481	0.078	0.196	0.196	-	-	-	0.124	0.280	0.124	-	-	-
C-B	632	0.217	0.217	0.310	-	-	-	-	-	-	-	-	-
D-A	671	-	-	-	-	-	-	0.231	-	0.091	-	-	-
D-B, nearside lane	531	0.136	0.136	0.310	-	-	-	0.217	0.217	0.086	-	-	-
D-B, offside lane	531	0.136	0.136	0.310	-	-	-	0.217	0.217	0.086	-	-	-
D-C	531	-	0.136	0.310	0.108	0.217	0.217	0.217	0.217	0.086	-	-	-

The slopes and intercepts shown above do NOT include any corrections or adjustments.

Streams may be combined, in which case capacity will be adjusted.
 Values are shown for the first time segment only; they may differ for subsequent time segments.

Traffic Demand

Demand Set Details

ID	Scenario name	Time Period name	Traffic profile type	Start time (HH:mm)	Finish time (HH:mm)	Time segment length (min)	Single time segment only
D1	DO NOTHING 2020	AM	FLAT	08:00	09:00	60	✓

Vehicle mix source	PCU Factor for a HV (PCU)
HV Percentages	2.00

Demand overview (Traffic)

Arm	Linked arm	Use O-D data	Average Demand (Veh/hr)	Scaling Factor (%)
A		✓	432	100.000
B		✓	47	100.000
C		✓	622	100.000
D		✓	183	100.000

Origin-Destination Data

Demand (Veh/hr)

		To				
		A	B	C	D	
From	A	0	24	327	81	
	B	15	0	24	8	
	C	546	36	0	40	
	D	131	7	45	0	

Vehicle Mix

Heavy Vehicle Percentages

		To				
		A	B	C	D	
From	A	0	0	5	0	
	B	0	0	0	0	
	C	5	0	0	0	
	D	0	0	0	0	

Results

Results Summary for whole modelled period

Stream	Max RFC	Max Delay (s)	Max Queue (Veh)	Max LOS
B-ACD	0.12	10.82	0.1	B
A-B				
A-C				
A-D	0.17	8.86	0.2	A
D-ABC	0.41	13.57	0.7	B
C-ABD	0.10	4.30	0.2	A
C-D				
C-A				

Main Results for each time segment

08:00 - 09:00

Stream	Total Demand (Veh/hr)	Capacity (Veh/hr)	RFC	Throughput (Veh/hr)	End queue (Veh)	Delay (s)	Unsignalised level of service
B-ACD	47	379	0.124	47	0.1	10.820	B
A-B	24			24			
A-C	327			327			
A-D	81	487	0.166	81	0.2	8.863	A
D-ABC	183	447	0.409	182	0.7	13.569	B
C-ABD	97	933	0.104	96	0.2	4.302	A
C-D	36			36			
C-A	489			489			

JUNCTION 2 - DO NOTHING 2020, PM

Data Errors and Warnings

No errors or warnings

Junction Network

Junctions

Junction	Name	Junction type	Major road direction	Use circulating lanes	Junction Delay (s)	Junction LOS
1	untitled	Crossroads	Two-way		4.49	A

Junction Network Options

Driving side	Lighting
Left	Normal/unknown

Traffic Demand

Demand Set Details

ID	Scenario name	Time Period name	Traffic profile type	Start time (HH:mm)	Finish time (HH:mm)	Time segment length (min)	Single time segment only
D2	DO NOTHING 2020	PM	FLAT	17:00	18:00	60	✓

Vehicle mix source	PCU Factor for a HV (PCU)
HV Percentages	2.00

Demand overview (Traffic)

Arm	Linked arm	Use O-D data	Average Demand (Veh/hr)	Scaling Factor (%)
A		✓	722	100.000
B		✓	152	100.000
C		✓	450	100.000
D		✓	160	100.000

Origin-Destination Data

Demand (Veh/hr)

		To			
		A	B	C	D
From	A	0	64	535	123
	B	43	0	91	18
	C	328	84	0	38
	D	112	15	33	0

Vehicle Mix

Heavy Vehicle Percentages

		To			
		A	B	C	D
From	A	0	0	5	0
	B	0	0	0	0
	C	5	0	0	0
	D	0	0	0	0

Results

Results Summary for whole modelled period

Stream	Max RFC	Max Delay (s)	Max Queue (Veh)	Max LOS
B-ACD	0.43	17.64	0.7	C
A-B				
A-C				
A-D	0.24	9.01	0.3	A
D-ABC	0.35	12.16	0.5	B
C-ABD	0.23	6.45	0.5	A
C-D				
C-A				

Main Results for each time segment

17:00 - 18:00

Stream	Total Demand (Veh/hr)	Capacity (Veh/hr)	RFC	Throughput (Veh/hr)	End queue (Veh)	Delay (s)	Unsignalised level of service
B-ACD	152	355	0.429	151	0.7	17.641	C
A-B	64			64			
A-C	535			535			
A-D	123	522	0.236	123	0.3	9.011	A
D-ABC	160	455	0.352	159	0.5	12.159	B
C-ABD	169	727	0.233	169	0.5	6.453	A
C-D	29			29			
C-A	252			252			

JUNCTION 2 - DO NOTHING 2024, AM

Data Errors and Warnings

No errors or warnings

Junction Network

Junctions

Junction	Name	Junction type	Major road direction	Use circulating lanes	Junction Delay (s)	Junction LOS
1	untitled	Crossroads	Two-way		3.37	A

Junction Network Options

Driving side	Lighting
Left	Normal/unknown

Traffic Demand

Demand Set Details

ID	Scenario name	Time Period name	Traffic profile type	Start time (HH:mm)	Finish time (HH:mm)	Time segment length (min)	Single time segment only
D3	DO NOTHING 2024	AM	FLAT	08:00	09:00	60	✓

Vehicle mix source	PCU Factor for a HV (PCU)
HV Percentages	2.00

Demand overview (Traffic)

Arm	Linked arm	Use O-D data	Average Demand (Veh/hr)	Scaling Factor (%)
A		✓	473	100.000
B		✓	51	100.000
C		✓	684	100.000
D		✓	195	100.000

Origin-Destination Data

Demand (Veh/hr)

		To			
		A	B	C	D
From	A	0	26	360	87
	B	16	0	26	9
	C	602	39	0	43
	D	140	7	48	0

Vehicle Mix

Heavy Vehicle Percentages

		To			
		A	B	C	D
From	A	0	0	5	0
	B	0	0	0	0
	C	5	0	0	0
	D	0	0	0	0

Results

Results Summary for whole modelled period

Stream	Max RFC	Max Delay (s)	Max Queue (Veh)	Max LOS
B-ACD	0.14	11.54	0.2	B
A-B				
A-C				
A-D	0.18	9.33	0.2	A
D-ABC	0.46	15.31	0.8	C
C-ABD	0.12	4.23	0.3	A
C-D				
C-A				

Main Results for each time segment

08:00 - 09:00

Stream	Total Demand (Veh/hr)	Capacity (Veh/hr)	RFC	Throughput (Veh/hr)	End queue (Veh)	Delay (s)	Unsignalised level of service
B-ACD	51	363	0.141	51	0.2	11.538	B
A-B	26			26			
A-C	360			360			
A-D	87	472	0.184	87	0.2	9.331	A
D-ABC	195	428	0.455	194	0.8	15.313	C
C-ABD	117	968	0.121	117	0.3	4.228	A
C-D	38			38			
C-A	529			529			

JUNCTION 2 - DO NOTHING 2024, PM

Data Errors and Warnings

No errors or warnings

Junction Network

Junctions

Junction	Name	Junction type	Major road direction	Use circulating lanes	Junction Delay (s)	Junction LOS
1	untitled	Crossroads	Two-way		4.96	A

Junction Network Options

Driving side	Lighting
Left	Normal/unknown

Traffic Demand

Demand Set Details

ID	Scenario name	Time Period name	Traffic profile type	Start time (HH:mm)	Finish time (HH:mm)	Time segment length (min)	Single time segment only
D4	DO NOTHING 2024	PM	FLAT	17:00	18:00	60	✓

Vehicle mix source	PCU Factor for a HV (PCU)
HV Percentages	2.00

Demand overview (Traffic)

Arm	Linked arm	Use O-D data	Average Demand (Veh/hr)	Scaling Factor (%)
A		✓	789	100.000
B		✓	162	100.000
C		✓	492	100.000
D		✓	171	100.000

Origin-Destination Data

Demand (Veh/hr)

		To			
		A	B	C	D
From	A	0	69	588	132
	B	46	0	97	19
	C	361	90	0	41
	D	120	16	35	0

Vehicle Mix

Heavy Vehicle Percentages

		To			
		A	B	C	D
From	A	0	0	5	0
	B	0	0	0	0
	C	5	0	0	0
	D	0	0	0	0

Results

Results Summary for whole modelled period

Stream	Max RFC	Max Delay (s)	Max Queue (Veh)	Max LOS
B-ACD	0.48	20.68	0.9	C
A-B				
A-C				
A-D	0.26	9.46	0.3	A
D-ABC	0.39	13.46	0.6	B
C-ABD	0.27	6.61	0.7	A
C-D				
C-A				

Main Results for each time segment

17:00 - 18:00

Stream	Total Demand (Veh/hr)	Capacity (Veh/hr)	RFC	Throughput (Veh/hr)	End queue (Veh)	Delay (s)	Unsignalised level of service
B-ACD	162	334	0.485	161	0.9	20.683	C
A-B	69			69			
A-C	588			588			
A-D	132	512	0.258	132	0.3	9.458	A
D-ABC	171	437	0.391	170	0.6	13.463	B
C-ABD	197	741	0.266	196	0.7	6.609	A
C-D	30			30			
C-A	265			265			

JUNCTION 2 - DO NOTHING 2029, AM

Data Errors and Warnings

No errors or warnings

Junction Network

Junctions

Junction	Name	Junction type	Major road direction	Use circulating lanes	Junction Delay (s)	Junction LOS
1	untitled	Crossroads	Two-way		3.88	A

Junction Network Options

Driving side	Lighting
Left	Normal/unknown

Traffic Demand

Demand Set Details

ID	Scenario name	Time Period name	Traffic profile type	Start time (HH:mm)	Finish time (HH:mm)	Time segment length (min)	Single time segment only
D5	DO NOTHING 2029	AM	FLAT	08:00	09:00	60	✓

Vehicle mix source	PCU Factor for a HV (PCU)
HV Percentages	2.00

Demand overview (Traffic)

Arm	Linked arm	Use O-D data	Average Demand (Veh/hr)	Scaling Factor (%)
A		✓	543	100.000
B		✓	55	100.000
C		✓	754	100.000
D		✓	214	100.000

Origin-Destination Data

Demand (Veh/hr)

		To			
		A	B	C	D
From	A	0	28	420	95
	B	18	0	28	9
	C	665	42	0	47
	D	153	8	53	0

Vehicle Mix

Heavy Vehicle Percentages

		To			
		A	B	C	D
From	A	0	0	5	0
	B	0	0	0	0
	C	5	0	0	0
	D	0	0	0	0

Results

Results Summary for whole modelled period

Stream	Max RFC	Max Delay (s)	Max Queue (Veh)	Max LOS
B-ACD	0.16	12.78	0.2	B
A-B				
A-C				
A-D	0.21	9.95	0.3	A
D-ABC	0.53	18.78	1.1	C
C-ABD	0.14	4.18	0.4	A
C-D				
C-A				

Main Results for each time segment

08:00 - 09:00

Stream	Total Demand (Veh/hr)	Capacity (Veh/hr)	RFC	Throughput (Veh/hr)	End queue (Veh)	Delay (s)	Unsignalised level of service
B-ACD	55	336	0.164	55	0.2	12.779	B
A-B	28			28			
A-C	420			420			
A-D	95	456	0.208	95	0.3	9.950	A
D-ABC	214	404	0.530	213	1.1	18.779	C
C-ABD	144	1005	0.143	144	0.4	4.179	A
C-D	40			40			
C-A	570			570			

JUNCTION 2 - DO NOTHING 2029, PM

Data Errors and Warnings

No errors or warnings

Junction Network

Junctions

Junction	Name	Junction type	Major road direction	Use circulating lanes	Junction Delay (s)	Junction LOS
1	untitled	Crossroads	Two-way		6.06	A

Junction Network Options

Driving side	Lighting
Left	Normal/unknown

Traffic Demand

Demand Set Details

ID	Scenario name	Time Period name	Traffic profile type	Start time (HH:mm)	Finish time (HH:mm)	Time segment length (min)	Single time segment only
D6	DO NOTHING 2029	PM	FLAT	17:00	18:00	60	✓

Vehicle mix source	PCU Factor for a HV (PCU)
HV Percentages	2.00

Demand overview (Traffic)

Arm	Linked arm	Use O-D data	Average Demand (Veh/hr)	Scaling Factor (%)
A		✓	881	100.000
B		✓	177	100.000
C		✓	571	100.000
D		✓	188	100.000

Origin-Destination Data

Demand (Veh/hr)

		To			
		A	B	C	D
From	A	0	75	662	144
	B	50	0	106	21
	C	429	98	0	44
	D	131	18	39	0

Vehicle Mix

Heavy Vehicle Percentages

		To			
		A	B	C	D
From	A	0	0	5	0
	B	0	0	0	0
	C	5	0	0	0
	D	0	0	0	0

Results

Results Summary for whole modelled period

Stream	Max RFC	Max Delay (s)	Max Queue (Veh)	Max LOS
B-ACD	0.59	28.10	1.4	D
A-B				
A-C				
A-D	0.29	10.28	0.4	B
D-ABC	0.47	16.68	0.9	C
C-ABD	0.32	6.81	1.0	A
C-D				
C-A				

Main Results for each time segment

17:00 - 18:00

Stream	Total Demand (Veh/hr)	Capacity (Veh/hr)	RFC	Throughput (Veh/hr)	End queue (Veh)	Delay (s)	Unsignalised level of service
B-ACD	177	302	0.585	176	1.4	28.105	D
A-B	75			75			
A-C	662			662			
A-D	144	493	0.292	144	0.4	10.283	B
D-ABC	188	402	0.467	187	0.9	16.675	C
C-ABD	250	778	0.322	249	1.0	6.813	A
C-D	30			30			
C-A	291			291			

JUNCTION 2 - DO NOTHING 2039, AM

Data Errors and Warnings

No errors or warnings

Junction Network

Junctions

Junction	Name	Junction type	Major road direction	Use circulating lanes	Junction Delay (s)	Junction LOS
1	untitled	Crossroads	Two-way		4.48	A

Junction Network Options

Driving side	Lighting
Left	Normal/unknown

Traffic Demand

Demand Set Details

ID	Scenario name	Time Period name	Traffic profile type	Start time (HH:mm)	Finish time (HH:mm)	Time segment length (min)	Single time segment only
D7	DO NOTHING 2039	AM	FLAT	08:00	09:00	60	✓

Vehicle mix source	PCU Factor for a HV (PCU)
HV Percentages	2.00

Demand overview (Traffic)

Arm	Linked arm	Use O-D data	Average Demand (Veh/hr)	Scaling Factor (%)
A		✓	580	100.000
B		✓	59	100.000
C		✓	808	100.000
D		✓	229	100.000

Origin-Destination Data

Demand (Veh/hr)

		To			
		A	B	C	D
From	A	0	30	448	102
	B	19	0	30	10
	C	713	45	0	50
	D	164	9	56	0

Vehicle Mix

Heavy Vehicle Percentages

		To			
		A	B	C	D
From	A	0	0	5	0
	B	0	0	0	0
	C	5	0	0	0
	D	0	0	0	0

Results

Results Summary for whole modelled period

Stream	Max RFC	Max Delay (s)	Max Queue (Veh)	Max LOS
B-ACD	0.18	13.77	0.2	B
A-B				
A-C				
A-D	0.23	10.52	0.3	B
D-ABC	0.59	22.50	1.4	C
C-ABD	0.16	4.16	0.5	A
C-D				
C-A				

Main Results for each time segment

08:00 - 09:00

Stream	Total Demand (Veh/hr)	Capacity (Veh/hr)	RFC	Throughput (Veh/hr)	End queue (Veh)	Delay (s)	Unsignalised level of service
B-ACD	59	320	0.184	59	0.2	13.768	B
A-B	30			30			
A-C	448			448			
A-D	102	444	0.230	102	0.3	10.516	B
D-ABC	229	386	0.593	228	1.4	22.504	C
C-ABD	171	1036	0.165	170	0.5	4.155	A
C-D	42			42			
C-A	596			596			

JUNCTION 2 - DO NOTHING 2039, PM

Data Errors and Warnings

No errors or warnings

Junction Network

Junctions

Junction	Name	Junction type	Major road direction	Use circulating lanes	Junction Delay (s)	Junction LOS
1	untitled	Crossroads	Two-way		7.51	A

Junction Network Options

Driving side	Lighting
Left	Normal/unknown

Traffic Demand

Demand Set Details

ID	Scenario name	Time Period name	Traffic profile type	Start time (HH:mm)	Finish time (HH:mm)	Time segment length (min)	Single time segment only
D8	DO NOTHING 2039	PM	FLAT	17:00	18:00	60	✓

Vehicle mix source	PCU Factor for a HV (PCU)
HV Percentages	2.00

Demand overview (Traffic)

Arm	Linked arm	Use O-D data	Average Demand (Veh/hr)	Scaling Factor (%)
A		✓	943	100.000
B		✓	191	100.000
C		✓	611	100.000
D		✓	201	100.000

Origin-Destination Data

Demand (Veh/hr)

		To			
		A	B	C	D
From	A	0	80	709	154
	B	54	0	114	23
	C	458	105	0	48
	D	141	19	41	0

Vehicle Mix

Heavy Vehicle Percentages

		To			
		A	B	C	D
From	A	0	0	5	0
	B	0	0	0	0
	C	5	0	0	0
	D	0	0	0	0

Results

Results Summary for whole modelled period

Stream	Max RFC	Max Delay (s)	Max Queue (Veh)	Max LOS
B-ACD	0.68	38.37	2.1	E
A-B				
A-C				
A-D	0.32	10.89	0.5	B
D-ABC	0.52	19.46	1.1	C
C-ABD	0.37	7.17	1.2	A
C-D				
C-A				

Main Results for each time segment

17:00 - 18:00

Stream	Total Demand (Veh/hr)	Capacity (Veh/hr)	RFC	Throughput (Veh/hr)	End queue (Veh)	Delay (s)	Unsignalised level of service
B-ACD	191	281	0.680	189	2.1	38.370	E
A-B	80			80			
A-C	709			709			
A-D	154	484	0.318	154	0.5	10.889	B
D-ABC	201	384	0.524	200	1.1	19.456	C
C-ABD	291	792	0.367	290	1.2	7.165	A
C-D	30			30			
C-A	290			290			

JUNCTION 2 - DO SOMETHING 2024, AM

Data Errors and Warnings

No errors or warnings

Junction Network

Junctions

Junction	Name	Junction type	Major road direction	Use circulating lanes	Junction Delay (s)	Junction LOS
1	untitled	Crossroads	Two-way		3.38	A

Junction Network Options

Driving side	Lighting
Left	Normal/unknown

Traffic Demand

Demand Set Details

ID	Scenario name	Time Period name	Traffic profile type	Start time (HH:mm)	Finish time (HH:mm)	Time segment length (min)	Single time segment only
D9	DO SOMETHING 2024	AM	FLAT	08:00	09:00	60	✓

Vehicle mix source	PCU Factor for a HV (PCU)
HV Percentages	2.00

Demand overview (Traffic)

Arm	Linked arm	Use O-D data	Average Demand (Veh/hr)	Scaling Factor (%)
A		✓	491	100.000
B		✓	51	100.000
C		✓	722	100.000
D		✓	195	100.000

Origin-Destination Data

Demand (Veh/hr)

		To			
		A	B	C	D
From	A	0	26	378	87
	B	16	0	26	9
	C	640	39	0	43
	D	140	7	48	0

Vehicle Mix

Heavy Vehicle Percentages

		To			
		A	B	C	D
From	A	0	0	5	0
	B	0	0	0	0
	C	5	0	0	0
	D	0	0	0	0

Results

Results Summary for whole modelled period

Stream	Max RFC	Max Delay (s)	Max Queue (Veh)	Max LOS
B-ACD	0.14	11.86	0.2	B
A-B				
A-C				
A-D	0.19	9.54	0.2	A
D-ABC	0.47	16.07	0.9	C
C-ABD	0.13	4.15	0.3	A
C-D				
C-A				

Main Results for each time segment

08:00 - 09:00

Stream	Total Demand (Veh/hr)	Capacity (Veh/hr)	RFC	Throughput (Veh/hr)	End queue (Veh)	Delay (s)	Unsignalised level of service
B-ACD	51	354	0.144	51	0.2	11.858	B
A-B	26			26			
A-C	378			378			
A-D	87	464	0.188	87	0.2	9.543	A
D-ABC	195	417	0.467	194	0.9	16.073	C
C-ABD	125	992	0.126	125	0.3	4.151	A
C-D	38			38			
C-A	559			559			

JUNCTION 2 - DO SOMETHING 2024, PM

Data Errors and Warnings

No errors or warnings

Junction Network

Junctions

Junction	Name	Junction type	Major road direction	Use circulating lanes	Junction Delay (s)	Junction LOS
1	untitled	Crossroads	Two-way		4.99	A

Junction Network Options

Driving side	Lighting
Left	Normal/unknown

Traffic Demand

Demand Set Details

ID	Scenario name	Time Period name	Traffic profile type	Start time (HH:mm)	Finish time (HH:mm)	Time segment length (min)	Single time segment only
D10	DO SOMETHING 2024	PM	FLAT	17:00	18:00	60	✓

Vehicle mix source	PCU Factor for a HV (PCU)
HV Percentages	2.00

Demand overview (Traffic)

Arm	Linked arm	Use O-D data	Average Demand (Veh/hr)	Scaling Factor (%)
A		✓	814	100.000
B		✓	162	100.000
C		✓	508	100.000
D		✓	171	100.000

Origin-Destination Data

Demand (Veh/hr)

		To			
		A	B	C	D
From	A	0	69	613	132
	B	46	0	97	19
	C	377	90	0	41
	D	120	16	35	0

Vehicle Mix

Heavy Vehicle Percentages

		To			
		A	B	C	D
From	A	0	0	5	0
	B	0	0	0	0
	C	5	0	0	0
	D	0	0	0	0

Results

Results Summary for whole modelled period

Stream	Max RFC	Max Delay (s)	Max Queue (Veh)	Max LOS
B-ACD	0.50	21.62	1.0	C
A-B				
A-C				
A-D	0.26	9.55	0.3	A
D-ABC	0.40	13.82	0.7	B
C-ABD	0.27	6.60	0.7	A
C-D				
C-A				

Main Results for each time segment

17:00 - 18:00

Stream	Total Demand (Veh/hr)	Capacity (Veh/hr)	RFC	Throughput (Veh/hr)	End queue (Veh)	Delay (s)	Unsignalised level of service
B-ACD	162	327	0.496	161	1.0	21.625	C
A-B	69			69			
A-C	613			613			
A-D	132	508	0.260	132	0.3	9.550	A
D-ABC	171	430	0.398	170	0.7	13.823	B
C-ABD	204	748	0.272	203	0.7	6.603	A
C-D	30			30			
C-A	274			274			

JUNCTION 2 - DO SOMETHING 2029, AM

Data Errors and Warnings

No errors or warnings

Junction Network

Junctions

Junction	Name	Junction type	Major road direction	Use circulating lanes	Junction Delay (s)	Junction LOS
1	untitled	Crossroads	Two-way		3.94	A

Junction Network Options

Driving side	Lighting
Left	Normal/unknown

Traffic Demand

Demand Set Details

ID	Scenario name	Time Period name	Traffic profile type	Start time (HH:mm)	Finish time (HH:mm)	Time segment length (min)	Single time segment only
D11	DO SOMETHING 2029	AM	FLAT	08:00	09:00	60	✓

Vehicle mix source	PCU Factor for a HV (PCU)
HV Percentages	2.00

Demand overview (Traffic)

Arm	Linked arm	Use O-D data	Average Demand (Veh/hr)	Scaling Factor (%)
A		✓	561	100.000
B		✓	55	100.000
C		✓	791	100.000
D		✓	214	100.000

Origin-Destination Data

Demand (Veh/hr)

		To			
		A	B	C	D
From	A	0	28	438	95
	B	18	0	28	9
	C	702	42	0	47
	D	153	8	53	0

Vehicle Mix

Heavy Vehicle Percentages

		To			
		A	B	C	D
From	A	0	0	5	0
	B	0	0	0	0
	C	5	0	0	0
	D	0	0	0	0

Results

Results Summary for whole modelled period

Stream	Max RFC	Max Delay (s)	Max Queue (Veh)	Max LOS
B-ACD	0.17	13.18	0.2	B
A-B				
A-C				
A-D	0.21	10.19	0.3	B
D-ABC	0.55	19.93	1.2	C
C-ABD	0.15	4.11	0.4	A
C-D				
C-A				

Main Results for each time segment

08:00 - 09:00

Stream	Total Demand (Veh/hr)	Capacity (Veh/hr)	RFC	Throughput (Veh/hr)	End queue (Veh)	Delay (s)	Unsignalised level of service
B-ACD	55	328	0.168	55	0.2	13.183	B
A-B	28			28			
A-C	438			438			
A-D	95	448	0.212	95	0.3	10.187	B
D-ABC	214	392	0.546	213	1.2	19.934	C
C-ABD	154	1029	0.150	154	0.4	4.112	A
C-D	40			40			
C-A	597			597			

JUNCTION 2 - DO SOMETHING 2029, PM

Data Errors and Warnings

No errors or warnings

Junction Network

Junctions

Junction	Name	Junction type	Major road direction	Use circulating lanes	Junction Delay (s)	Junction LOS
1	untitled	Crossroads	Two-way		6.20	A

Junction Network Options

Driving side	Lighting
Left	Normal/unknown

Traffic Demand

Demand Set Details

ID	Scenario name	Time Period name	Traffic profile type	Start time (HH:mm)	Finish time (HH:mm)	Time segment length (min)	Single time segment only
D12	DO SOMETHING 2029	PM	FLAT	17:00	18:00	60	✓

Vehicle mix source	PCU Factor for a HV (PCU)
HV Percentages	2.00

Demand overview (Traffic)

Arm	Linked arm	Use O-D data	Average Demand (Veh/hr)	Scaling Factor (%)
A		✓	907	100.000
B		✓	177	100.000
C		✓	587	100.000
D		✓	188	100.000

Origin-Destination Data

Demand (Veh/hr)

		To			
		A	B	C	D
From	A	0	75	688	144
	B	50	0	106	21
	C	445	98	0	44
	D	131	18	39	0

Vehicle Mix

Heavy Vehicle Percentages

		To			
		A	B	C	D
From	A	0	0	5	0
	B	0	0	0	0
	C	5	0	0	0
	D	0	0	0	0

Results

Results Summary for whole modelled period

Stream	Max RFC	Max Delay (s)	Max Queue (Veh)	Max LOS
B-ACD	0.60	30.00	1.5	D
A-B				
A-C				
A-D	0.29	10.39	0.4	B
D-ABC	0.48	17.28	0.9	C
C-ABD	0.33	6.83	1.0	A
C-D				
C-A				

Main Results for each time segment

17:00 - 18:00

Stream	Total Demand (Veh/hr)	Capacity (Veh/hr)	RFC	Throughput (Veh/hr)	End queue (Veh)	Delay (s)	Unsignalised level of service
B-ACD	177	294	0.602	176	1.5	30.003	D
A-B	75			75			
A-C	688			688			
A-D	144	490	0.294	144	0.4	10.389	B
D-ABC	188	395	0.476	187	0.9	17.277	C
C-ABD	260	785	0.331	259	1.0	6.834	A
C-D	29			29			
C-A	298			298			

JUNCTION 2 - DO SOMETHING 2039, AM

Data Errors and Warnings

No errors or warnings

Junction Network

Junctions

Junction	Name	Junction type	Major road direction	Use circulating lanes	Junction Delay (s)	Junction LOS
1	untitled	Crossroads	Two-way		4.61	A

Junction Network Options

Driving side	Lighting
Left	Normal/unknown

Traffic Demand

Demand Set Details

ID	Scenario name	Time Period name	Traffic profile type	Start time (HH:mm)	Finish time (HH:mm)	Time segment length (min)	Single time segment only
D13	DO SOMETHING 2039	AM	FLAT	08:00	09:00	60	✓

Vehicle mix source	PCU Factor for a HV (PCU)
HV Percentages	2.00

Demand overview (Traffic)

Arm	Linked arm	Use O-D data	Average Demand (Veh/hr)	Scaling Factor (%)
A		✓	599	100.000
B		✓	59	100.000
C		✓	846	100.000
D		✓	229	100.000

Origin-Destination Data

Demand (Veh/hr)

		To			
		A	B	C	D
From	A	0	30	467	102
	B	19	0	30	10
	C	751	45	0	50
	D	164	9	56	0

Vehicle Mix

Heavy Vehicle Percentages

		To			
		A	B	C	D
From	A	0	0	5	0
	B	0	0	0	0
	C	5	0	0	0
	D	0	0	0	0

Results

Results Summary for whole modelled period

Stream	Max RFC	Max Delay (s)	Max Queue (Veh)	Max LOS
B-ACD	0.19	14.27	0.2	B
A-B				
A-C				
A-D	0.23	10.79	0.3	B
D-ABC	0.61	24.27	1.5	C
C-ABD	0.17	4.10	0.5	A
C-D				
C-A				

Main Results for each time segment

08:00 - 09:00

Stream	Total Demand (Veh/hr)	Capacity (Veh/hr)	RFC	Throughput (Veh/hr)	End queue (Veh)	Delay (s)	Unsignalised level of service
B-ACD	59	311	0.190	59	0.2	14.269	B
A-B	30			30			
A-C	467			467			
A-D	102	435	0.234	102	0.3	10.787	B
D-ABC	229	374	0.612	227	1.5	24.269	C
C-ABD	183	1061	0.173	183	0.5	4.099	A
C-D	41			41			
C-A	621			621			

JUNCTION 2 - DO SOMETHING 2039, PM

Data Errors and Warnings

No errors or warnings

Junction Network

Junctions

Junction	Name	Junction type	Major road direction	Use circulating lanes	Junction Delay (s)	Junction LOS
1	untitled	Crossroads	Two-way		7.84	A

Junction Network Options

Driving side	Lighting
Left	Normal/unknown

Traffic Demand

Demand Set Details

ID	Scenario name	Time Period name	Traffic profile type	Start time (HH:mm)	Finish time (HH:mm)	Time segment length (min)	Single time segment only
D14	DO SOMETHING 2039	PM	FLAT	17:00	18:00	60	✓

Vehicle mix source	PCU Factor for a HV (PCU)
HV Percentages	2.00

Demand overview (Traffic)

Arm	Linked arm	Use O-D data	Average Demand (Veh/hr)	Scaling Factor (%)
A		✓	969	100.000
B		✓	191	100.000
C		✓	627	100.000
D		✓	201	100.000

Origin-Destination Data

Demand (Veh/hr)

		To			
		A	B	C	D
From	A	0	80	735	154
	B	54	0	114	23
	C	474	105	0	48
	D	141	19	41	0

Vehicle Mix

Heavy Vehicle Percentages

		To			
		A	B	C	D
From	A	0	0	5	0
	B	0	0	0	0
	C	5	0	0	0
	D	0	0	0	0

Results

Results Summary for whole modelled period

Stream	Max RFC	Max Delay (s)	Max Queue (Veh)	Max LOS
B-ACD	0.70	42.06	2.3	E
A-B				
A-C				
A-D	0.32	11.01	0.5	B
D-ABC	0.53	20.32	1.1	C
C-ABD	0.38	7.21	1.3	A
C-D				
C-A				

Main Results for each time segment

17:00 - 18:00

Stream	Total Demand (Veh/hr)	Capacity (Veh/hr)	RFC	Throughput (Veh/hr)	End queue (Veh)	Delay (s)	Unsignalised level of service
B-ACD	191	272	0.702	189	2.3	42.055	E
A-B	80			80			
A-C	735			735			
A-D	154	480	0.321	154	0.5	11.011	B
D-ABC	201	376	0.535	200	1.1	20.317	C
C-ABD	302	800	0.377	301	1.3	7.209	A
C-D	30			30			
C-A	295			295			

<h1>Junctions 9</h1>
<h2>ARCADY 9 - Roundabout Module</h2>
Version: 9.5.1.7462 © Copyright TRL Limited, 2019
For sales and distribution information, program advice and maintenance, contact TRL: +44 (0)1344 379777 software@trl.co.uk www.trlsoftware.co.uk
The users of this computer program for the solution of an engineering problem are in no way relieved of their responsibility for the correctness of the solution

Filename: Junction 3 - AM-PM.j9

Path: M:\Projects\12\12-081A - Dunshaughlin Phase 2 - Civils\Design\Traffic\Modelling AUGUST 2020\Junction 3

Report generation date: 19/08/2020 12:10:33

- »JUNCTION 3 - DO NOTHING 2020, AM
- »JUNCTION 3 - DO NOTHING 2020, PM
- »JUNCTION 3 - DO NOTHING 2024, AM
- »JUNCTION 3 - DO NOTHING 2024, PM
- »JUNCTION 3 - DO NOTHING 2029, AM
- »JUNCTION 3 - DO NOTHING 2029, PM
- »JUNCTION 3 - DO NOTHING 2039, AM
- »JUNCTION 3 - DO NOTHING 2039, PM
- »JUNCTION 3 - DO SOMETHING 2024, AM
- »JUNCTION 3 - DO SOMETHING 2024, PM
- »JUNCTION 3 - DO SOMETHING 2029, AM
- »JUNCTION 3 - DO SOMETHING 2029, PM
- »JUNCTION 3 - DO SOMETHING 2039, AM
- »JUNCTION 3 - DO SOMETHING 2039, PM

Summary of junction performance

	AM					PM				
	Set ID	Queue (Veh)	Delay (s)	RFC	LOS	Set ID	Queue (Veh)	Delay (s)	RFC	LOS
JUNCTION 3 - DO NOTHING 2020										
Arm 1	D1	0.4	4.23	0.29	A	D2	0.4	3.98	0.27	A
Arm 2		0.3	3.41	0.25	A		0.3	3.37	0.25	A
Arm 3		0.2	3.80	0.13	A		0.1	3.28	0.05	A
Arm 4		0.2	3.21	0.14	A		0.1	2.88	0.06	A
JUNCTION 3 - DO NOTHING 2024										
Arm 1	D3	0.5	4.48	0.33	A	D4	0.4	4.19	0.30	A
Arm 2		0.4	3.56	0.28	A		0.4	3.54	0.29	A
Arm 3		0.2	3.98	0.15	A		0.1	3.40	0.06	A
Arm 4		0.2	3.31	0.15	A		0.1	2.95	0.07	A
JUNCTION 3 - DO NOTHING 2029										
Arm 1	D5	0.6	4.88	0.38	A	D6	0.5	4.50	0.35	A
Arm 2		0.5	3.75	0.31	A		0.5	3.81	0.33	A
Arm 3		0.2	4.25	0.17	A		0.1	3.58	0.08	A
Arm 4		0.2	3.48	0.17	A		0.1	3.06	0.08	A
JUNCTION 3 - DO NOTHING 2039										
Arm 1	D7	0.7	5.16	0.41	A	D8	0.6	4.70	0.37	A
Arm 2		0.5	3.91	0.34	A		0.6	3.98	0.36	A
Arm 3		0.2	4.46	0.19	A		0.1	3.68	0.08	A
Arm 4		0.2	3.59	0.19	A		0.1	3.11	0.09	A
JUNCTION 3 - DO SOMETHING 2024										
Arm 1	D9	0.6	4.84	0.36	A	D10	0.5	4.41	0.33	A
Arm 2		0.5	3.77	0.32	A		0.5	3.74	0.32	A
Arm 3		0.3	4.53	0.23	A		0.1	3.54	0.09	A
Arm 4		0.2	3.51	0.16	A		0.1	3.03	0.08	A
JUNCTION 3 - DO SOMETHING 2029										
Arm 1	D11	0.7	5.30	0.41	A	D12	0.6	4.76	0.38	A
Arm 2		0.5	3.98	0.35	A		0.6	4.06	0.37	A
Arm 3		0.4	4.88	0.26	A		0.1	3.74	0.11	A
Arm 4		0.2	3.70	0.19	A		0.1	3.14	0.09	A
JUNCTION 3 - DO SOMETHING 2039										
Arm 1	D13	0.8	5.62	0.44	A	D14	0.7	4.98	0.40	A
Arm 2		0.6	4.16	0.37	A		0.7	4.25	0.39	A
Arm 3		0.4	5.18	0.28	A		0.1	3.85	0.11	A
Arm 4		0.3	3.82	0.20	A		0.1	3.19	0.10	A

Values shown are the highest values encountered over all time segments. Delay is the maximum value of average delay per arriving vehicle.

File summary

File Description

Title	
Location	
Site number	
Date	04/03/2020
Version	
Status	(new file)
Identifier	
Client	
Jobnumber	
Enumerator	DOMAINf.silva
Description	

Units

Distance units	Speed units	Traffic units input	Traffic units results	Flow units	Average delay units	Total delay units	Rate of delay units
m	kph	Veh	Veh	perHour	s	-Min	perMin

Analysis Options

Calculate Queue Percentiles	Calculate residual capacity	RFC Threshold	Average Delay threshold (s)	Queue threshold (PCU)
		0.85	36.00	20.00

Demand Set Summary

ID	Scenario name	Time Period name	Traffic profile type	Start time (HH:mm)	Finish time (HH:mm)	Time segment length (min)	Single time segment only
D1	DO NOTHING 2020	AM	FLAT	08:00	09:00	60	✓
D2	DO NOTHING 2020	PM	FLAT	17:00	18:00	60	✓
D3	DO NOTHING 2024	AM	FLAT	08:00	09:00	60	✓
D4	DO NOTHING 2024	PM	FLAT	17:00	18:00	60	✓
D5	DO NOTHING 2029	AM	FLAT	08:00	09:00	60	✓
D6	DO NOTHING 2029	PM	FLAT	17:00	18:00	60	✓
D7	DO NOTHING 2039	AM	FLAT	08:00	09:00	60	✓
D8	DO NOTHING 2039	PM	FLAT	17:00	18:00	60	✓
D9	DO SOMETHING 2024	AM	FLAT	08:00	09:00	60	✓
D10	DO SOMETHING 2024	PM	FLAT	17:00	18:00	60	✓
D11	DO SOMETHING 2029	AM	FLAT	08:00	09:00	60	✓
D12	DO SOMETHING 2029	PM	FLAT	17:00	18:00	60	✓
D13	DO SOMETHING 2039	AM	FLAT	08:00	09:00	60	✓
D14	DO SOMETHING 2039	PM	FLAT	17:00	18:00	60	✓

Analysis Set Details

ID	Name	Network flow scaling factor (%)
A1	JUNCTION 3	100.000

JUNCTION 3 - DO NOTHING 2020, AM

Data Errors and Warnings

No errors or warnings

Junction Network

Junctions

Junction	Name	Junction type	Use circulating lanes	Arm order	Junction Delay (s)	Junction LOS
1	untitled	Standard Roundabout		1, 2, 3, 4	3.71	A

Junction Network Options

Driving side	Lighting
Left	Normal/unknown

Arms

Arms

Arm	Name	Description
1	Drumree Road (E)	
2	R125 (S)	
3	L2208 (W)	
4	R125 (N)	

Roundabout Geometry

Arm	V - Approach road half-width (m)	E - Entry width (m)	I' - Effective flare length (m)	R - Entry radius (m)	D - Inscribed circle diameter (m)	PHI - Conflict (entry) angle (deg)	Exit only
1	3.80	4.80	4.0	20.0	50.0	30.0	
2	3.80	6.10	12.0	16.0	50.0	30.0	
3	3.80	5.50	4.6	20.0	50.0	30.0	
4	3.80	6.60	8.1	17.0	50.0	30.0	

Zebra Crossings

Arm	Space between crossing and junction entry (Zebra) (PCU)	Vehicles queueing on exit (Zebra) (PCU)	Central Refuge	Crossing data type	Crossing length (m)	Crossing time (s)
4	1.00	1.00		Distance	12.00	8.57

Slope / Intercept / Capacity

Roundabout Slope and Intercept used in model

Arm	Final slope	Final intercept (PCU/hr)
1	0.537	1320
2	0.579	1564
3	0.549	1387
4	0.576	1541

The slope and intercept shown above include any corrections and adjustments.

Traffic Demand

Demand Set Details

ID	Scenario name	Time Period name	Traffic profile type	Start time (HH:mm)	Finish time (HH:mm)	Time segment length (min)	Single time segment only
D1	DO NOTHING 2020	AM	FLAT	08:00	09:00	60	✓

Vehicle mix source	PCU Factor for a HV (PCU)
HV Percentages	2.00

Demand overview (Traffic)

Arm	Linked arm	Use O-D data	Average Demand (Veh/hr)	Scaling Factor (%)
1		✓	349	100.000
2		✓	354	100.000
3		✓	144	100.000
4		✓	176	100.000

Demand overview (Pedestrians)

Arm	Average pedestrian flow (Ped/hr)
1	
2	
3	
4	50.00

Origin-Destination Data

Demand (Veh/hr)

	To				
	1	2	3	4	
From	1	0	215	51	83
	2	210	0	10	134
	3	84	31	0	29
	4	58	105	13	0

Vehicle Mix

Heavy Vehicle Percentages

	To				
	1	2	3	4	
From	1	0	5	0	0
	2	5	0	0	5
	3	0	0	0	0
	4	0	5	0	0

Results

Results Summary for whole modelled period

Arm	Max RFC	Max Delay (s)	Max Queue (Veh)	Max LOS
1	0.29	4.23	0.4	A
2	0.25	3.41	0.3	A
3	0.13	3.80	0.2	A
4	0.14	3.21	0.2	A

Main Results for each time segment

08:00 - 09:00

Arm	Total Demand (Veh/hr)	Circulating flow (Veh/hr)	Pedestrian demand (Ped/hr)	Capacity (Veh/hr)	RFC	Throughput (Veh/hr)	End queue (Veh)	Delay (s)	Unsignalised level of service
1	349	149		1200	0.291	349	0.4	4.226	A
2	354	147		1410	0.251	354	0.3	3.406	A
3	144	427		1091	0.132	144	0.2	3.800	A
4	176	325	50.00	1296	0.136	176	0.2	3.212	A

JUNCTION 3 - DO NOTHING 2020, PM

Data Errors and Warnings

No errors or warnings

Junction Network

Junctions

Junction	Name	Junction type	Use circulating lanes	Arm order	Junction Delay (s)	Junction LOS
1	untitled	Standard Roundabout		1, 2, 3, 4	3.56	A

Junction Network Options

Driving side	Lighting
Left	Normal/unknown

Traffic Demand

Demand Set Details

ID	Scenario name	Time Period name	Traffic profile type	Start time (HH:mm)	Finish time (HH:mm)	Time segment length (min)	Single time segment only
D2	DO NOTHING 2020	PM	FLAT	17:00	18:00	60	✓

Vehicle mix source	PCU Factor for a HV (PCU)
HV Percentages	2.00

Demand overview (Traffic)

Arm	Linked arm	Use O-D data	Average Demand (Veh/hr)	Scaling Factor (%)
1		✓	332	100.000
2		✓	360	100.000
3		✓	63	100.000
4		✓	78	100.000

Demand overview (Pedestrians)

Arm	Average pedestrian flow (Ped/hr)
1	
2	
3	
4	50.00

Origin-Destination Data

Demand (Veh/hr)

		To			
		1	2	3	4
From	1	0	220	94	18
	2	200	0	29	131
	3	42	13	0	8
	4	15	55	8	0

Vehicle Mix

Heavy Vehicle Percentages

	To				
	1	2	3	4	
From	1	0	5	0	0
	2	5	0	0	5
	3	0	0	0	0
	4	0	5	0	0

Results

Results Summary for whole modelled period

Arm	Max RFC	Max Delay (s)	Max Queue (Veh)	Max LOS
1	0.27	3.98	0.4	A
2	0.25	3.37	0.3	A
3	0.05	3.28	0.1	A
4	0.06	2.88	0.1	A

Main Results for each time segment

17:00 - 18:00

Arm	Total Demand (Veh/hr)	Circulating flow (Veh/hr)	Pedestrian demand (Ped/hr)	Capacity (Veh/hr)	RFC	Throughput (Veh/hr)	End queue (Veh)	Delay (s)	Unsignalised level of service
1	332	76		1237	0.268	332	0.4	3.976	A
2	360	120		1429	0.252	360	0.3	3.367	A
3	63	349		1160	0.054	63	0.1	3.281	A
4	78	255	50.00	1327	0.059	78	0.1	2.881	A

JUNCTION 3 - DO NOTHING 2024, AM

Data Errors and Warnings

No errors or warnings

Junction Network

Junctions

Junction	Name	Junction type	Use circulating lanes	Arm order	Junction Delay (s)	Junction LOS
1	untitled	Standard Roundabout		1, 2, 3, 4	3.89	A

Junction Network Options

Driving side	Lighting
Left	Normal/unknown

Traffic Demand

Demand Set Details

ID	Scenario name	Time Period name	Traffic profile type	Start time (HH:mm)	Finish time (HH:mm)	Time segment length (min)	Single time segment only
D3	DO NOTHING 2024	AM	FLAT	08:00	09:00	60	✓

Vehicle mix source	PCU Factor for a HV (PCU)
HV Percentages	2.00

Demand overview (Traffic)

Arm	Linked arm	Use O-D data	Average Demand (Veh/hr)	Scaling Factor (%)
1		✓	391	100.000
2		✓	391	100.000
3		✓	156	100.000
4		✓	189	100.000

Demand overview (Pedestrians)

Arm	Average pedestrian flow (Ped/hr)
1	
2	
3	
4	50.00

Origin-Destination Data

Demand (Veh/hr)

		To			
		1	2	3	4
From	1	0	242	57	92
	2	234	0	12	145
	3	91	34	0	31
	4	63	112	14	0

Vehicle Mix

Heavy Vehicle Percentages

	To				
	1	2	3	4	
From	1	0	5	0	0
	2	5	0	0	5
	3	0	0	0	0
	4	0	5	0	0

Results

Results Summary for whole modelled period

Arm	Max RFC	Max Delay (s)	Max Queue (Veh)	Max LOS
1	0.33	4.48	0.5	A
2	0.28	3.56	0.4	A
3	0.15	3.98	0.2	A
4	0.15	3.31	0.2	A

Main Results for each time segment

08:00 - 09:00

Arm	Total Demand (Veh/hr)	Circulating flow (Veh/hr)	Pedestrian demand (Ped/hr)	Capacity (Veh/hr)	RFC	Throughput (Veh/hr)	End queue (Veh)	Delay (s)	Unsignalised level of service
1	391	160		1194	0.327	391	0.5	4.477	A
2	391	163		1402	0.279	391	0.4	3.560	A
3	156	471		1060	0.147	156	0.2	3.983	A
4	189	359	50.00	1277	0.148	189	0.2	3.307	A

JUNCTION 3 - DO NOTHING 2024, PM

Data Errors and Warnings

No errors or warnings

Junction Network

Junctions

Junction	Name	Junction type	Use circulating lanes	Arm order	Junction Delay (s)	Junction LOS
1	untitled	Standard Roundabout		1, 2, 3, 4	3.73	A

Junction Network Options

Driving side	Lighting
Left	Normal/unknown

Traffic Demand

Demand Set Details

ID	Scenario name	Time Period name	Traffic profile type	Start time (HH:mm)	Finish time (HH:mm)	Time segment length (min)	Single time segment only
D4	DO NOTHING 2024	PM	FLAT	17:00	18:00	60	✓

Vehicle mix source	PCU Factor for a HV (PCU)
HV Percentages	2.00

Demand overview (Traffic)

Arm	Linked arm	Use O-D data	Average Demand (Veh/hr)	Scaling Factor (%)
1		✓	374	100.000
2		✓	405	100.000
3		✓	72	100.000
4		✓	87	100.000

Demand overview (Pedestrians)

Arm	Average pedestrian flow (Ped/hr)
1	
2	
3	
4	50.00

Origin-Destination Data

Demand (Veh/hr)

		To			
		1	2	3	4
From	1	0	249	103	22
	2	232	0	32	141
	3	48	15	0	9
	4	19	59	9	0

Vehicle Mix

Heavy Vehicle Percentages

	To				
	1	2	3	4	
From	1	0	5	0	0
	2	5	0	0	5
	3	0	0	0	0
	4	0	5	0	0

Results

Results Summary for whole modelled period

Arm	Max RFC	Max Delay (s)	Max Queue (Veh)	Max LOS
1	0.30	4.19	0.4	A
2	0.29	3.54	0.4	A
3	0.06	3.40	0.1	A
4	0.07	2.95	0.1	A

Main Results for each time segment

17:00 - 18:00

Arm	Total Demand (Veh/hr)	Circulating flow (Veh/hr)	Pedestrian demand (Ped/hr)	Capacity (Veh/hr)	RFC	Throughput (Veh/hr)	End queue (Veh)	Delay (s)	Unsignalised level of service
1	374	83		1233	0.303	374	0.4	4.189	A
2	405	134		1421	0.285	405	0.4	3.539	A
3	72	395		1130	0.064	72	0.1	3.402	A
4	87	295	50.00	1307	0.067	87	0.1	2.951	A

JUNCTION 3 - DO NOTHING 2029, AM

Data Errors and Warnings

No errors or warnings

Junction Network

Junctions

Junction	Name	Junction type	Use circulating lanes	Arm order	Junction Delay (s)	Junction LOS
1	untitled	Standard Roundabout		1, 2, 3, 4	4.17	A

Junction Network Options

Driving side	Lighting
Left	Normal/unknown

Traffic Demand

Demand Set Details

ID	Scenario name	Time Period name	Traffic profile type	Start time (HH:mm)	Finish time (HH:mm)	Time segment length (min)	Single time segment only
D5	DO NOTHING 2029	AM	FLAT	08:00	09:00	60	✓

Vehicle mix source	PCU Factor for a HV (PCU)
HV Percentages	2.00

Demand overview (Traffic)

Arm	Linked arm	Use O-D data	Average Demand (Veh/hr)	Scaling Factor (%)
1		✓	445	100.000
2		✓	433	100.000
3		✓	177	100.000
4		✓	218	100.000

Demand overview (Pedestrians)

Arm	Average pedestrian flow (Ped/hr)
1	
2	
3	
4	50.00

Origin-Destination Data

Demand (Veh/hr)

		To			
		1	2	3	4
From	1	0	280	63	102
	2	260	0	14	159
	3	103	40	0	34
	4	75	128	15	0

Vehicle Mix

Heavy Vehicle Percentages

	To				
	1	2	3	4	
From	1	0	5	0	0
	2	5	0	0	5
	3	0	0	0	0
	4	0	5	0	0

Results

Results Summary for whole modelled period

Arm	Max RFC	Max Delay (s)	Max Queue (Veh)	Max LOS
1	0.38	4.88	0.6	A
2	0.31	3.75	0.5	A
3	0.17	4.25	0.2	A
4	0.17	3.48	0.2	A

Main Results for each time segment

08:00 - 09:00

Arm	Total Demand (Veh/hr)	Circulating flow (Veh/hr)	Pedestrian demand (Ped/hr)	Capacity (Veh/hr)	RFC	Throughput (Veh/hr)	End queue (Veh)	Delay (s)	Unsignalised level of service
1	445	183		1181	0.377	444	0.6	4.882	A
2	433	180		1393	0.311	433	0.5	3.748	A
3	177	520		1024	0.173	177	0.2	4.250	A
4	218	403	50.00	1253	0.174	218	0.2	3.477	A

JUNCTION 3 - DO NOTHING 2029, PM

Data Errors and Warnings

No errors or warnings

Junction Network

Junctions

Junction	Name	Junction type	Use circulating lanes	Arm order	Junction Delay (s)	Junction LOS
1	untitled	Standard Roundabout		1, 2, 3, 4	4.00	A

Junction Network Options

Driving side	Lighting
Left	Normal/unknown

Traffic Demand

Demand Set Details

ID	Scenario name	Time Period name	Traffic profile type	Start time (HH:mm)	Finish time (HH:mm)	Time segment length (min)	Single time segment only
D6	DO NOTHING 2029	PM	FLAT	17:00	18:00	60	✓

Vehicle mix source	PCU Factor for a HV (PCU)
HV Percentages	2.00

Demand overview (Traffic)

Arm	Linked arm	Use O-D data	Average Demand (Veh/hr)	Scaling Factor (%)
1		✓	428	100.000
2		✓	467	100.000
3		✓	82	100.000
4		✓	104	100.000

Demand overview (Pedestrians)

Arm	Average pedestrian flow (Ped/hr)
1	
2	
3	
4	50.00

Origin-Destination Data

Demand (Veh/hr)

		To			
		1	2	3	4
From	1	0	282	116	30
	2	270	0	38	159
	3	55	18	0	9
	4	26	69	9	0

Vehicle Mix

Heavy Vehicle Percentages

	To				
	1	2	3	4	
From	1	0	5	0	0
	2	5	0	0	5
	3	0	0	0	0
	4	0	5	0	0

Results

Results Summary for whole modelled period

Arm	Max RFC	Max Delay (s)	Max Queue (Veh)	Max LOS
1	0.35	4.50	0.5	A
2	0.33	3.81	0.5	A
3	0.08	3.58	0.1	A
4	0.08	3.06	0.1	A

Main Results for each time segment

17:00 - 18:00

Arm	Total Demand (Veh/hr)	Circulating flow (Veh/hr)	Pedestrian demand (Ped/hr)	Capacity (Veh/hr)	RFC	Throughput (Veh/hr)	End queue (Veh)	Delay (s)	Unsignalised level of service
1	428	96		1226	0.349	427	0.5	4.505	A
2	467	155		1410	0.331	467	0.5	3.815	A
3	82	459		1087	0.075	82	0.1	3.581	A
4	104	343	50.00	1281	0.081	104	0.1	3.059	A

JUNCTION 3 - DO NOTHING 2039, AM

Data Errors and Warnings

No errors or warnings

Junction Network

Junctions

Junction	Name	Junction type	Use circulating lanes	Arm order	Junction Delay (s)	Junction LOS
1	untitled	Standard Roundabout		1, 2, 3, 4	4.37	A

Junction Network Options

Driving side	Lighting
Left	Normal/unknown

Traffic Demand

Demand Set Details

ID	Scenario name	Time Period name	Traffic profile type	Start time (HH:mm)	Finish time (HH:mm)	Time segment length (min)	Single time segment only
D7	DO NOTHING 2039	AM	FLAT	08:00	09:00	60	✓

Vehicle mix source	PCU Factor for a HV (PCU)
HV Percentages	2.00

Demand overview (Traffic)

Arm	Linked arm	Use O-D data	Average Demand (Veh/hr)	Scaling Factor (%)
1		✓	477	100.000
2		✓	465	100.000
3		✓	189	100.000
4		✓	234	100.000

Demand overview (Pedestrians)

Arm	Average pedestrian flow (Ped/hr)
1	
2	
3	
4	50.00

Origin-Destination Data

Demand (Veh/hr)

		To			
		1	2	3	4
From	1	0	299	68	110
	2	279	0	15	171
	3	110	43	0	36
	4	80	138	16	0

Vehicle Mix

Heavy Vehicle Percentages

	To				
	1	2	3	4	
From	1	0	5	0	0
	2	5	0	0	5
	3	0	0	0	0
	4	0	5	0	0

Results

Results Summary for whole modelled period

Arm	Max RFC	Max Delay (s)	Max Queue (Veh)	Max LOS
1	0.41	5.16	0.7	A
2	0.34	3.91	0.5	A
3	0.19	4.46	0.2	A
4	0.19	3.59	0.2	A

Main Results for each time segment

08:00 - 09:00

Arm	Total Demand (Veh/hr)	Circulating flow (Veh/hr)	Pedestrian demand (Ped/hr)	Capacity (Veh/hr)	RFC	Throughput (Veh/hr)	End queue (Veh)	Delay (s)	Unsignalised level of service
1	477	197		1174	0.406	476	0.7	5.158	A
2	465	194		1385	0.336	464	0.5	3.910	A
3	189	559		995	0.190	189	0.2	4.464	A
4	234	432	50.00	1237	0.189	234	0.2	3.589	A

JUNCTION 3 - DO NOTHING 2039, PM

Data Errors and Warnings

No errors or warnings

Junction Network

Junctions

Junction	Name	Junction type	Use circulating lanes	Arm order	Junction Delay (s)	Junction LOS
1	untitled	Standard Roundabout		1, 2, 3, 4	4.16	A

Junction Network Options

Driving side	Lighting
Left	Normal/unknown

Traffic Demand

Demand Set Details

ID	Scenario name	Time Period name	Traffic profile type	Start time (HH:mm)	Finish time (HH:mm)	Time segment length (min)	Single time segment only
D8	DO NOTHING 2039	PM	FLAT	17:00	18:00	60	✓

Vehicle mix source	PCU Factor for a HV (PCU)
HV Percentages	2.00

Demand overview (Traffic)

Arm	Linked arm	Use O-D data	Average Demand (Veh/hr)	Scaling Factor (%)
1		✓	457	100.000
2		✓	500	100.000
3		✓	88	100.000
4		✓	111	100.000

Demand overview (Pedestrians)

Arm	Average pedestrian flow (Ped/hr)
1	
2	
3	
4	50.00

Origin-Destination Data

Demand (Veh/hr)

		To			
		1	2	3	4
From	1	0	302	124	31
	2	288	0	41	171
	3	59	19	0	10
	4	27	74	10	0

Vehicle Mix

Heavy Vehicle Percentages

	To				
	1	2	3	4	
From	1	0	5	0	0
	2	5	0	0	5
	3	0	0	0	0
	4	0	5	0	0

Results

Results Summary for whole modelled period

Arm	Max RFC	Max Delay (s)	Max Queue (Veh)	Max LOS
1	0.37	4.70	0.6	A
2	0.36	3.98	0.6	A
3	0.08	3.68	0.1	A
4	0.09	3.11	0.1	A

Main Results for each time segment

17:00 - 18:00

Arm	Total Demand (Veh/hr)	Circulating flow (Veh/hr)	Pedestrian demand (Ped/hr)	Capacity (Veh/hr)	RFC	Throughput (Veh/hr)	End queue (Veh)	Delay (s)	Unsignalised level of service
1	457	103		1222	0.374	456	0.6	4.699	A
2	500	165		1404	0.356	499	0.6	3.976	A
3	88	489		1066	0.083	88	0.1	3.681	A
4	111	366	50.00	1267	0.088	111	0.1	3.112	A

JUNCTION 3 - DO SOMETHING 2024, AM

Data Errors and Warnings

No errors or warnings

Junction Network

Junctions

Junction	Name	Junction type	Use circulating lanes	Arm order	Junction Delay (s)	Junction LOS
1	untitled	Standard Roundabout		1, 2, 3, 4	4.21	A

Junction Network Options

Driving side	Lighting
Left	Normal/unknown

Traffic Demand

Demand Set Details

ID	Scenario name	Time Period name	Traffic profile type	Start time (HH:mm)	Finish time (HH:mm)	Time segment length (min)	Single time segment only
D9	DO SOMETHING 2024	AM	FLAT	08:00	09:00	60	✓

Vehicle mix source	PCU Factor for a HV (PCU)
HV Percentages	2.00

Demand overview (Traffic)

Arm	Linked arm	Use O-D data	Average Demand (Veh/hr)	Scaling Factor (%)
1		✓	417	100.000
2		✓	440	100.000
3		✓	242	100.000
4		✓	200	100.000

Demand overview (Pedestrians)

Arm	Average pedestrian flow (Ped/hr)
1	
2	
3	
4	50.00

Origin-Destination Data

Demand (Veh/hr)

		To			
		1	2	3	4
From	1	0	251	66	100
	2	250	0	37	153
	3	113	94	0	35
	4	67	117	16	0

Vehicle Mix

Heavy Vehicle Percentages

From	To			
	1	2	3	4
1	0	5	0	0
2	5	0	0	5
3	0	0	0	0
4	0	5	0	0

Results

Results Summary for whole modelled period

Arm	Max RFC	Max Delay (s)	Max Queue (Veh)	Max LOS
1	0.36	4.84	0.6	A
2	0.32	3.77	0.5	A
3	0.23	4.53	0.3	A
4	0.16	3.51	0.2	A

Main Results for each time segment

08:00 - 09:00

Arm	Total Demand (Veh/hr)	Circulating flow (Veh/hr)	Pedestrian demand (Ped/hr)	Capacity (Veh/hr)	RFC	Throughput (Veh/hr)	End queue (Veh)	Delay (s)	Unsignalised level of service
1	417	227		1160	0.359	416	0.6	4.838	A
2	440	182		1395	0.315	440	0.5	3.766	A
3	242	502		1036	0.234	242	0.3	4.533	A
4	200	456	50.00	1224	0.163	200	0.2	3.514	A

JUNCTION 3 - DO SOMETHING 2024, PM

Data Errors and Warnings

No errors or warnings

Junction Network

Junctions

Junction	Name	Junction type	Use circulating lanes	Arm order	Junction Delay (s)	Junction LOS
1	untitled	Standard Roundabout		1, 2, 3, 4	3.91	A

Junction Network Options

Driving side	Lighting
Left	Normal/unknown

Traffic Demand

Demand Set Details

ID	Scenario name	Time Period name	Traffic profile type	Start time (HH:mm)	Finish time (HH:mm)	Time segment length (min)	Single time segment only
D10	DO SOMETHING 2024	PM	FLAT	17:00	18:00	60	✓

Vehicle mix source	PCU Factor for a HV (PCU)
HV Percentages	2.00

Demand overview (Traffic)

Arm	Linked arm	Use O-D data	Average Demand (Veh/hr)	Scaling Factor (%)
1		✓	403	100.000
2		✓	455	100.000
3		✓	102	100.000
4		✓	101	100.000

Demand overview (Pedestrians)

Arm	Average pedestrian flow (Ped/hr)
1	
2	
3	
4	50.00

Origin-Destination Data

Demand (Veh/hr)

		To			
		1	2	3	4
From	1	0	260	117	26
	2	239	0	71	145
	3	56	36	0	10
	4	25	65	11	0

Vehicle Mix

Heavy Vehicle Percentages

		To			
		1	2	3	4
From	1	0	5	0	0
	2	5	0	0	5
	3	0	0	0	0
	4	0	5	0	0

Results

Results Summary for whole modelled period

Arm	Max RFC	Max Delay (s)	Max Queue (Veh)	Max LOS
1	0.33	4.41	0.5	A
2	0.32	3.74	0.5	A
3	0.09	3.54	0.1	A
4	0.08	3.03	0.1	A

Main Results for each time segment

17:00 - 18:00

Arm	Total Demand (Veh/hr)	Circulating flow (Veh/hr)	Pedestrian demand (Ped/hr)	Capacity (Veh/hr)	RFC	Throughput (Veh/hr)	End queue (Veh)	Delay (s)	Unsignalised level of service
1	403	112		1219	0.331	403	0.5	4.408	A
2	455	154		1415	0.322	455	0.5	3.745	A
3	102	410		1119	0.091	102	0.1	3.538	A
4	101	331	50.00	1289	0.078	101	0.1	3.029	A

JUNCTION 3 - DO SOMETHING 2029, AM

Data Errors and Warnings

No errors or warnings

Junction Network

Junctions

Junction	Name	Junction type	Use circulating lanes	Arm order	Junction Delay (s)	Junction LOS
1	untitled	Standard Roundabout		1, 2, 3, 4	4.53	A

Junction Network Options

Driving side	Lighting
Left	Normal/unknown

Traffic Demand

Demand Set Details

ID	Scenario name	Time Period name	Traffic profile type	Start time (HH:mm)	Finish time (HH:mm)	Time segment length (min)	Single time segment only
D11	DO SOMETHING 2029	AM	FLAT	08:00	09:00	60	✓

Vehicle mix source	PCU Factor for a HV (PCU)
HV Percentages	2.00

Demand overview (Traffic)

Arm	Linked arm	Use O-D data	Average Demand (Veh/hr)	Scaling Factor (%)
1		✓	470	100.000
2		✓	483	100.000
3		✓	262	100.000
4		✓	227	100.000

Demand overview (Pedestrians)

Arm	Average pedestrian flow (Ped/hr)
1	
2	
3	
4	50.00

Origin-Destination Data

Demand (Veh/hr)

		To			
		1	2	3	4
From	1	0	288	72	110
	2	276	0	39	168
	3	124	100	0	38
	4	78	132	17	0

Vehicle Mix

Heavy Vehicle Percentages

	To				
	1	2	3	4	
From	1	0	5	0	0
	2	5	0	0	5
	3	0	0	0	0
	4	0	5	0	0

Results

Results Summary for whole modelled period

Arm	Max RFC	Max Delay (s)	Max Queue (Veh)	Max LOS
1	0.41	5.30	0.7	A
2	0.35	3.98	0.5	A
3	0.26	4.88	0.4	A
4	0.19	3.70	0.2	A

Main Results for each time segment

08:00 - 09:00

Arm	Total Demand (Veh/hr)	Circulating flow (Veh/hr)	Pedestrian demand (Ped/hr)	Capacity (Veh/hr)	RFC	Throughput (Veh/hr)	End queue (Veh)	Delay (s)	Unsignalised level of service
1	470	249		1148	0.410	469	0.7	5.302	A
2	483	199		1385	0.349	482	0.5	3.985	A
3	262	553		999	0.262	262	0.4	4.882	A
4	227	499	50.00	1200	0.189	227	0.2	3.698	A

JUNCTION 3 - DO SOMETHING 2029, PM

Data Errors and Warnings

No errors or warnings

Junction Network

Junctions

Junction	Name	Junction type	Use circulating lanes	Arm order	Junction Delay (s)	Junction LOS
1	untitled	Standard Roundabout		1, 2, 3, 4	4.21	A

Junction Network Options

Driving side	Lighting
Left	Normal/unknown

Traffic Demand

Demand Set Details

ID	Scenario name	Time Period name	Traffic profile type	Start time (HH:mm)	Finish time (HH:mm)	Time segment length (min)	Single time segment only
D12	DO SOMETHING 2029	PM	FLAT	17:00	18:00	60	✓

Vehicle mix source	PCU Factor for a HV (PCU)
HV Percentages	2.00

Demand overview (Traffic)

Arm	Linked arm	Use O-D data	Average Demand (Veh/hr)	Scaling Factor (%)
1		✓	457	100.000
2		✓	518	100.000
3		✓	114	100.000
4		✓	116	100.000

Demand overview (Pedestrians)

Arm	Average pedestrian flow (Ped/hr)
1	
2	
3	
4	50.00

Origin-Destination Data

Demand (Veh/hr)

		To			
		1	2	3	4
From	1	0	294	130	33
	2	277	0	78	163
	3	63	40	0	11
	4	30	74	12	0

Vehicle Mix

Heavy Vehicle Percentages

	To				
	1	2	3	4	
From	1	0	5	0	0
	2	5	0	0	5
	3	0	0	0	0
	4	0	5	0	0

Results

Results Summary for whole modelled period

Arm	Max RFC	Max Delay (s)	Max Queue (Veh)	Max LOS
1	0.38	4.76	0.6	A
2	0.37	4.06	0.6	A
3	0.11	3.74	0.1	A
4	0.09	3.14	0.1	A

Main Results for each time segment

17:00 - 18:00

Arm	Total Demand (Veh/hr)	Circulating flow (Veh/hr)	Pedestrian demand (Ped/hr)	Capacity (Veh/hr)	RFC	Throughput (Veh/hr)	End queue (Veh)	Delay (s)	Unsignalised level of service
1	457	126		1211	0.377	456	0.6	4.765	A
2	518	175		1403	0.369	517	0.6	4.061	A
3	114	472		1077	0.106	114	0.1	3.738	A
4	116	380	50.00	1262	0.092	116	0.1	3.140	A

JUNCTION 3 - DO SOMETHING 2039, AM

Data Errors and Warnings

No errors or warnings

Junction Network

Junctions

Junction	Name	Junction type	Use circulating lanes	Arm order	Junction Delay (s)	Junction LOS
1	untitled	Standard Roundabout		1, 2, 3, 4	4.77	A

Junction Network Options

Driving side	Lighting
Left	Normal/unknown

Traffic Demand

Demand Set Details

ID	Scenario name	Time Period name	Traffic profile type	Start time (HH:mm)	Finish time (HH:mm)	Time segment length (min)	Single time segment only
D13	DO SOMETHING 2039	AM	FLAT	08:00	09:00	60	✓

Vehicle mix source	PCU Factor for a HV (PCU)
HV Percentages	2.00

Demand overview (Traffic)

Arm	Linked arm	Use O-D data	Average Demand (Veh/hr)	Scaling Factor (%)
1		✓	502	100.000
2		✓	514	100.000
3		✓	276	100.000
4		✓	242	100.000

Demand overview (Pedestrians)

Arm	Average pedestrian flow (Ped/hr)
1	
2	
3	
4	50.00

Origin-Destination Data

Demand (Veh/hr)

		To			
		1	2	3	4
From	1	0	307	77	118
	2	295	0	40	179
	3	132	103	0	41
	4	83	141	18	0

Vehicle Mix

Heavy Vehicle Percentages

	To				
	1	2	3	4	
From	1	0	5	0	0
	2	5	0	0	5
	3	0	0	0	0
	4	0	5	0	0

Results

Results Summary for whole modelled period

Arm	Max RFC	Max Delay (s)	Max Queue (Veh)	Max LOS
1	0.44	5.62	0.8	A
2	0.37	4.16	0.6	A
3	0.28	5.18	0.4	A
4	0.20	3.82	0.3	A

Main Results for each time segment

08:00 - 09:00

Arm	Total Demand (Veh/hr)	Circulating flow (Veh/hr)	Pedestrian demand (Ped/hr)	Capacity (Veh/hr)	RFC	Throughput (Veh/hr)	End queue (Veh)	Delay (s)	Unsignalised level of service
1	502	262		1141	0.440	501	0.8	5.622	A
2	514	213		1377	0.373	513	0.6	4.164	A
3	276	591		971	0.284	276	0.4	5.178	A
4	242	529	50.00	1183	0.205	242	0.3	3.824	A

JUNCTION 3 - DO SOMETHING 2039, PM

Data Errors and Warnings

No errors or warnings

Junction Network

Junctions

Junction	Name	Junction type	Use circulating lanes	Arm order	Junction Delay (s)	Junction LOS
1	untitled	Standard Roundabout		1, 2, 3, 4	4.39	A

Junction Network Options

Driving side	Lighting
Left	Normal/unknown

Traffic Demand

Demand Set Details

ID	Scenario name	Time Period name	Traffic profile type	Start time (HH:mm)	Finish time (HH:mm)	Time segment length (min)	Single time segment only
D14	DO SOMETHING 2039	PM	FLAT	17:00	18:00	60	✓

Vehicle mix source	PCU Factor for a HV (PCU)
HV Percentages	2.00

Demand overview (Traffic)

Arm	Linked arm	Use O-D data	Average Demand (Veh/hr)	Scaling Factor (%)
1		✓	486	100.000
2		✓	551	100.000
3		✓	119	100.000
4		✓	123	100.000

Demand overview (Pedestrians)

Arm	Average pedestrian flow (Ped/hr)
1	
2	
3	
4	50.00

Origin-Destination Data

Demand (Veh/hr)

		To			
		1	2	3	4
From	1	0	313	138	35
	2	295	0	81	175
	3	66	41	0	12
	4	32	78	13	0

Vehicle Mix

Heavy Vehicle Percentages

	To				
	1	2	3	4	
From	1	0	5	0	0
	2	5	0	0	5
	3	0	0	0	0
	4	0	5	0	0

Results

Results Summary for whole modelled period

Arm	Max RFC	Max Delay (s)	Max Queue (Veh)	Max LOS
1	0.40	4.98	0.7	A
2	0.39	4.25	0.7	A
3	0.11	3.85	0.1	A
4	0.10	3.19	0.1	A

Main Results for each time segment

17:00 - 18:00

Arm	Total Demand (Veh/hr)	Circulating flow (Veh/hr)	Pedestrian demand (Ped/hr)	Capacity (Veh/hr)	RFC	Throughput (Veh/hr)	End queue (Veh)	Delay (s)	Unsignalised level of service
1	486	132		1208	0.402	485	0.7	4.977	A
2	551	186		1397	0.394	550	0.7	4.250	A
3	119	504		1054	0.113	119	0.1	3.848	A
4	123	402	50.00	1250	0.098	123	0.1	3.194	A

TRANSYT 15
Version: 15.5.2.7994 © Copyright TRL Limited, 2018
For sales and distribution information, program advice and maintenance, contact TRL: +44 (0)1344 379777 software@trl.co.uk www.trisoftware.co.uk
The users of this computer program for the solution of an engineering problem are in no way relieved of their responsibility for the correctness of the solution

Filename: Junction 4 - AM.t15

Path: M:\Projects\12\12-081A - Dunshaughlin Phase 2 - Civils\Design\Traffic\Modelling AUGUST 2020\Junction 4

Report generation date: 19/08/2020 12:11:58

- »A1 - DO NOTHING 2024 : D1 - DO NOTHING 2024* :
- »A2 - DO NOTHING 2029 : D2 - DO NOTHING 2029* :
- »A3 - DO NOTHING 2039 : D3 - DO NOTHING 2039* :
- »A4 - DO SOMETHING 2024 : D4 - DO SOMETHING 2024* :
- »A5 - DO SOMETHING 2029 : D5 - DO SOMETHING 2029* :
- »A6 - DO SOMETHING 2039 : D6 - DO SOMETHING 2039* :

File summary

File description

File title	(untitled)
Location	
Site number	
UTCRegion	
Driving side	Left
Date	06/12/2011
Version	
Status	(new file)
Identifier	
Client	
Jobnumber	
Enumerator	DOMAINf.silva
Description	

Model and Results

Enable controller offsets	Enable fuel consumption	Enable quick flares	Display journey time results	Display level of service results	Display blocking and starvation results	Display end of red and green queue results	Display excess queue results	Display separate uniform and random results	Display unweighted results	Display TRANSYT 12 style timings	Display effective greens in results	Display Red-With-Amber	Display End-Of-Green Amber
			✓		✓		✓	✓					

Units

Cost units	Speed units	Distance units	Fuel economy units	Fuel rate units	Mass units	Traffic units input	Traffic units results	Flow units	Average delay units	Total delay units	Rate of delay units
£	kph	m	mpg	l/h	kg	Veh	Veh	perHour	s	-Hour	perHour

Sorting

Show names instead of IDs	Sorting direction	Sorting type	Ignore prefixes when sorting	Analysis/demand set sorting	Link grouping	Source grouping	Colour Analysis/Demand Sets
	Ascending	Numerical		ID	Normal	Normal	✓

A1 - DO NOTHING 2024 D1 - DO NOTHING 2024*

Summary

Data Errors and Warnings

No errors or warnings

Run Summary

Analysis set used	Run start time	Run finish time	Modelling start time (HH:mm)	Network Cycle Time (s)	Performance Index (£ per hr)	Total network delay (Veh-hr/hr)	Highest DOS (%)	Item with highest DOS	Number of oversaturated items	Percentage of oversaturated items (%)	Item with worst signalised PRC	Item with worst unsignalised PRC	Item with worst over PR
1	19/08/2020 12:11:19	19/08/2020 12:11:20	08:00	120	189.38	12.71	63.41	A/1	0	0	A/1	Dx/1	A/

Analysis Set Details

Name	Description	Demand set	Include in report	Locked
DO NOTHING 2024	AM	D1	✓	

Demand Set Details

Name	Description	Composite	Demand sets	Start time (HH:mm)	Locked
DO NOTHING 2024	AM			08:00	

Arms and Traffic Streams

Arms

Arm	Name	Description	Traffic node
A	(untitled)		1
Ax	(untitled)		
B	(untitled)		1
Bx	(untitled)		
C	(untitled)		1
Cx	(untitled)		
D	(untitled)		1
Dx	(untitled)		

Traffic Streams

Arm	Traffic Stream	Name	Description	Auto length	Length (m)	Has Saturation Flow	Saturation flow source	Saturation flow (PCU/hr)	Is signal controlled	Is give way	Traffic type	Allow Nearside Turn On Red
A	1	(untitled)		✓	50.00	✓	Sum of lanes	1800	✓		Normal	
Ax	1	(untitled)		✓	137.53						Normal	
B	1	(untitled)		✓	50.00	✓	Sum of lanes	1800	✓		Normal	
Bx	1	(untitled)		✓	138.27						Normal	
C	1	(untitled)		✓	50.00	✓	Sum of lanes	1800	✓		Normal	
	2	(untitled)		✓	50.00	✓	Sum of lanes	1800	✓		Normal	
Cx	1	(untitled)		✓	140.00						Normal	
D	1	(untitled)		✓	50.00	✓	Sum of lanes	1800	✓		Normal	
Dx	1	(untitled)		✓	137.05						Normal	

Lanes

Arm	Traffic Stream	Lane	Name	Description	Use RR67	Saturation flow (PCU/hr)
A	1	1	(untitled)			1800
Ax	1	1	(untitled)			
B	1	1	(untitled)			1800
Bx	1	1	(untitled)			
C	1	1	(untitled)			1800
	2	1	(untitled)			1800
Cx	1	1	(untitled)			
D	1	1	(untitled)			1800
Dx	1	1	(untitled)			

Modelling

Arm	Traffic Stream	Traffic model	Stop weighting multiplier (%)	Delay weighting multiplier (%)	Assignment Cost Weighting (%)	Exclude from results calculation	Max queue storage (PCU)	Has queue limit	Has degree of saturation limit
(ALL)	(ALL)	NetworkDefault	100	100	100		0.00		

Modelling - Advanced

Arm	Traffic Stream	Initial queue (PCU)	Type of Vehicle-in-Service	Vehicle-in-Service	Type of random parameter	Random parameter	Auto cycle time	Cycle time
(ALL)	(ALL)	0.00	NetworkDefault	Not-Included	NetworkDefault	0.50	✓	120

Normal traffic - Modelling

Arm	Traffic Stream	Stop weighting (%)	Delay weighting (%)
(ALL)	(ALL)	100	100

Normal traffic - Advanced

Arm	Traffic Stream	Dispersion type for Normal Traffic
(ALL)	(ALL)	NetworkDefault

Flows

Arm	Traffic Stream	Total Flow (Veh/hr)	Normal Flow (Veh/hr)
A	1	390	390
Ax	1	407	407
B	1	10	10
Bx	1	6	6
C	1	388	388
	2	1	1
Cx	1	392	392
D	1	32	32
Dx	1	16	16

Signals

Arm	Traffic Stream	Controller stream	Phase	Second phase enabled
A	1	1	B	
B	1	1	C	
C	1	1	A	
	2	1	A	
D	1	1	D	

Pedestrian Crossings

Pedestrian Crossings

Crossing	Name	Description	Traffic node	Allow walk on red	Crossing type	Length (m)	Cruise time (seconds)	Cruise speed (kph)
1	(untitled)		1		Farside	7.00	4.67	5.40
2	(untitled)		1		Farside	8.00	5.33	5.40
3	(untitled)		1		Farside	8.00	5.33	5.40
4	(untitled)		1		Farside	7.00	4.67	5.40

Pedestrian Crossings - Signals

Crossing	Controller stream	Phase	Second phase enabled
(ALL)	1	E	

Pedestrian Crossings - Sides

Crossing	Side	Saturation flow (Ped/hr)
(ALL)	(ALL)	11000

Pedestrian Crossings - Modelling

Crossing	Side	Delay weighting (%)	Assignment Cost Weighting (%)	Exclude from results calculation	Max queue storage (Ped)	Has queue limit	Has degree of saturation limit
(ALL)	(ALL)	100	100		0.00		

Local OD Matrix - Local Matrix: 1

Local Matrix Options

OD Matrix	Name	Use for point to point table	Auto calculate	Allocation mode	Allow paths past exit locations	Allow looped paths on arms	Allow looped paths on traffic nodes	Copy flows	Matrix to copy flows from	Limit paths by length	Path length limit multiplier	Limit paths by number	Path number limit
1	(untitled)	✓	✓	Path Equalisation	✓		✓			✓	1.25		

Normal Input Flows (Veh/hr)

		To							
		1	2	3	4	5	6	7	8
From	1	0	7	381	1	0	0	0	0
	2	14	0	18	0	0	0	0	0
	3	376	9	0	5	0	0	0	0
	4	2	0	8	0	0	0	0	0
	5	0	0	0	0	0	0	0	0
	6	0	0	0	0	0	0	0	0
	7	0	0	0	0	0	0	0	0
	8	0	0	0	0	0	0	0	0

Bus Input Flows not shown as they are blank.

Tram Input Flows not shown as they are blank.

Pedestrian Input Flows (Veh/hr)

From	To							
	1	2	3	4	5	6	7	8
1	0	0	0	0	0	0	0	0
2	0	0	0	0	0	0	0	0
3	0	0	0	0	0	0	0	0
4	0	0	0	0	0	0	0	0
5	0	0	0	0	0	30	30	0
6	0	0	0	0	30	0	0	30
7	0	0	0	0	30	0	0	30
8	0	0	0	0	0	30	30	0

Locations

OD Matrix	Location	Name	Entries	Exits	Colour
1	1	(untitled)	C/1, C/2	Cx/1	#0000FF
	2	(untitled)	D/1	Dx/1	#FF0000
	3	(untitled)	A/1	Ax/1	#00FF00
	4	(untitled)	B/1	Bx/1	#FFFF00
	5	(untitled)	3:2E, 1:1E	3:2X, 1:1X	#FF00FF
	6	(untitled)	2:1E, 1:2E	2:1X, 1:2X	#008000
	7	(untitled)	4:2E, 3:1E	4:2X, 3:1X	#FFA500
	8	(untitled)	4:1E, 2:2E	4:1X, 2:2X	#00FFFF

Normal Paths and Flows

OD Matrix	Path	Description	From location	To location	Path items	Allocation type	Normal Calculated Flow (Veh/hr)
1	1		1	2	C/1, Dx/1	Normal	7
	2		1	3	C/1, Ax/1	Normal	381
	5		2	3	D/1, Ax/1	Normal	18
	6		2	4	D/1, Bx/1	Normal	0
	7		2	1	D/1, Cx/1	Normal	14
	8		3	2	A/1, Dx/1	Normal	9
	9		3	4	A/1, Bx/1	Normal	5
	10		3	1	A/1, Cx/1	Normal	376
	11		4	2	B/1, Dx/1	Normal	0
	12		4	3	B/1, Ax/1	Normal	8
	13		4	1	B/1, Cx/1	Normal	2
	21		1	4	C/2, Bx/1	Normal	1

Pedestrian Paths and Flows

OD Matrix	Path	Description	From location	To location	Path items	Allocation type	Pedestrian calculated flow (Ped/hr)
1	17		8	7	4:1E, 4:2X	Normal	30
	18		8	6	2:2E, 2:1X	Normal	30
	22		5	7	3:2E, 3:1X	Normal	30
	23		5	6	1:1E, 1:2X	Normal	30
	34		6	8	2:1E, 2:2X	Normal	30
	35		6	5	1:2E, 1:1X	Normal	30
	41		7	8	4:2E, 4:1X	Normal	30
	42		7	5	3:1E, 3:2X	Normal	30

Signal Timings

Network Default: 120s cycle time; 120 steps

Controller Stream 1

Controller Stream	Name	Description	Use sequence	Cycle time source	Cycle time (s)
1	(untitled)		1	NetworkDefault	120

Controller Stream 1 - Properties

Controller Stream	Manufacturer name	Type	Model number	(Telephone) Line Number	Site number	Grid reference	Gaining delay type
1	Unspecified						Relative

Controller Stream 1 - Optimisation

Controller Stream	Allow offset optimisation	Allow green split optimisation	Optimisation level	Auto redistribute	Enable stage constraint
1	✓	✓	Offsets And Green Splits	✓	

Phases

Controller Stream	Phase	Name	Minimum green (s)	Maximum green (s)	Relative start displacement (s)	Relative end displacement (s)	Type	Blackout Time (s)
1	A	(untitled)	38	300	0	0	Traffic	
	B	(untitled)	5	300	0	0	Traffic	
	C	(untitled)	5	300	0	0	Traffic	
	D	(untitled)	5	300	0	0	Traffic	
	E	(untitled)	5	300	0	0	Pedestrian	0

Library Stages

Controller Stream	Library Stage	Phases in stage	User stage minimum (s)
1	1	A	1
	2	B	1
	3	C	1
	4	D	1
	5	E	1

Stage Sequences

Controller Stream	Sequence	Name	Multiple cycling	Stage IDs	Stage ends
1	1	(untitled)	Single	1, 2, 3, 4, 5	29, 74, 84, 94, 104

Intergreen Matrix for Controller Stream 1

		To				
		A	B	C	D	E
From	A		5	5	5	5
	B	5		5	5	5
	C	5	5		5	5
	D	5	5	5		5
	E	5	5	5	5	

Banned Stage transitions for Controller Stream 1

		To				
		1	2	3	4	5
From	1					
	2					
	3					
	4					
	5					

Interstage Matrix for Controller Stream 1

		To				
		1	2	3	4	5
From	1	0	5	5	5	5
	2	5	0	5	5	5
	3	5	5	0	5	5
	4	5	5	5	0	5
	5	5	5	5	5	0

Resultant Stages

Controller Stream	Resultant Stage	Is base stage	Library Stage ID	Phases in this stage	Stage start (s)	Stage end (s)	Stage duration (s)	User stage minimum (s)	Stage minimum (s)
1	1	✓	1	A	109	29	40	1	38
	2	✓	2	B	34	74	40	1	5
	3	✓	3	C	79	84	5	1	5
	4	✓	4	D	89	94	5	1	5
	5	✓	5	E	99	104	5	1	5

Resultant Phase Green Periods

Controller Stream	Phase	Green period	Is base green period	Start time (s)	End time (s)	Duration (s)
1	A	1	✓	109	29	40
	B	1	✓	34	74	40
	C	1	✓	79	84	5
	D	1	✓	89	94	5
	E	1	✓	99	104	5

Traffic Stream Green Times

Arm	Traffic Stream	Traffic Node	Controller Stream	Phase	Green Period 1		
					Start	End	Duration
A	1	1	1	B	34	74	40
B	1	1	1	C	79	84	5
C	1	1	1	A	109	29	40
C	2	1	1	A	109	29	40
D	1	1	1	D	89	94	5

Phase Timings Diagram for Controller Stream 1

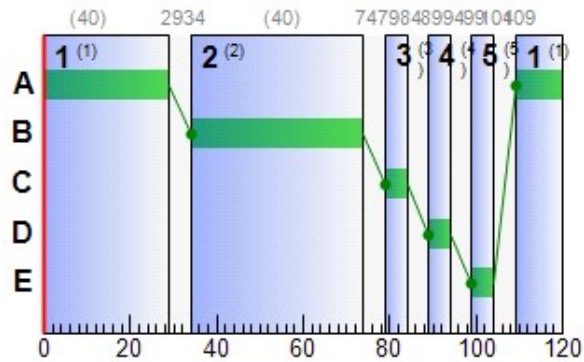

Stage Sequence Diagram for Controller Stream 1

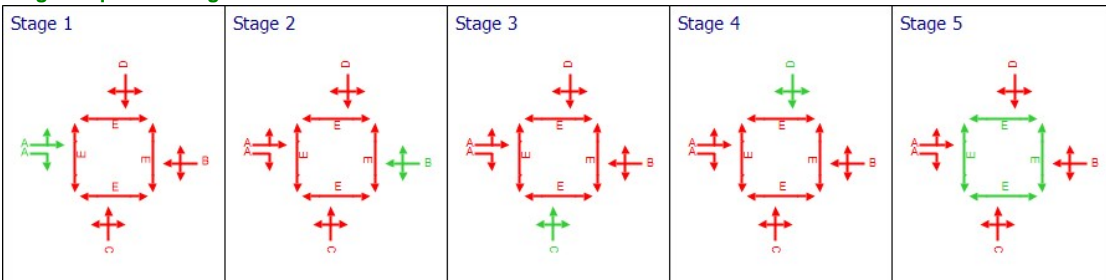

Resultant penalties

Time Segment	Controller stream	Phase min max penalty (£ per hr)	Intergreen broken penalty (£ per hr)	Stage constraint broken penalty (£ per hr)	Cost of controller stream penalties (£ per hr)
08:00-09:00	1	0.00	0.00	0.00	0.00

Traffic Stream Results

Traffic Stream Results: Vehicle summary

Time Segment	Arm	Traffic Stream	Degree of saturation (%)	Practical reserve capacity (%)	Calculated flow entering (Veh/hr)	Calculated sat flow (Veh/hr)	Actual green (s per cycle)	Mean Delay per Veh (s)	Mean max queue (Veh)	Utilised storage (%)	Weighted cost of delay (£ per hr)	Weighted cost of stops (£ per hr)	Performance Index (£ per hr)
08:00-09:00	A	1	63	58	390	1800	40	38.22	11.38	130.84	58.79	4.22	63.01
	Ax	1	0	Unrestricted	407	Unrestricted	120	0.00	0.00	0.00	0.00	0.00	0.00
	B	1	11	800	10	1800	5	57.12	0.32	3.72	2.25	0.12	2.37
	Bx	1	0	Unrestricted	6	Unrestricted	120	0.00	0.00	0.00	0.00	0.00	0.00
	C	1	63	59	388	1800	40	38.10	11.31	130.08	58.32	4.19	62.51
		2	0	61400	1	1800	40	26.34	0.00	0.00	0.10	0.01	0.11
	Cx	1	0	Unrestricted	392	Unrestricted	120	0.00	0.00	0.00	0.00	0.00	0.00
	D	1	36	181	32	1800	5	66.01	1.13	12.97	8.33	0.42	8.75
Dx	1	0	Unrestricted	16	Unrestricted	120	0.00	0.00	0.00	0.00	0.00	0.00	

Traffic Stream Results: Flows and signals

Time Segment	Arm	Traffic Stream	Calculated flow entering (Veh/hr)	Calculated flow out (Veh/hr)	Flow discrepancy (Veh/hr)	Adjusted flow warning	Calculated sat flow (Veh/hr)	Calculated capacity (Veh/hr)	Degree of saturation (%)	DOS Threshold exceeded	Practical reserve capacity (%)	Mean modulus of error	Actual green (s per cycle)
08:00-09:00	A	1	390	390	0		1800	615	63		58	0.00	40
	Ax	1	407	407	0		Unrestricted	Unrestricted	0		Unrestricted	1.12	120
	B	1	10	10	0		1800	90	11		800	0.00	5
	Bx	1	6	6	0		Unrestricted	Unrestricted	0		Unrestricted	0.99	120
	C	1	388	388	0		1800	615	63		59	0.00	40
		2	1	1	0		1800	615	0		61400	0.00	40
	Cx	1	392	392	0		Unrestricted	Unrestricted	0		Unrestricted	1.16	120
	D	1	32	32	0		1800	90	36		181	0.00	5
Dx	1	16	16	0		Unrestricted	Unrestricted	0		Unrestricted	0.74	120	

Traffic Stream Results: Stops and delays

Time Segment	Arm	Traffic Stream	Mean Cruise Time per Veh (s)	Mean Delay per Veh (s)	Uniform delay (Veh-hr/hr)	Random plus oversat delay (Veh-hr/hr)	Weighted cost of delay (£ per hr)	Mean stops per Veh (%)	Uniform stops (Stops per hr)	Random stops (Stops per hr)	Weighted cost of stops (£ per hr)
08:00-09:00	A	1	6.00	38.22	3.60	0.54	58.79	86.32	320.48	16.15	4.22
	Ax	1	16.50	0.00	0.00	0.00	0.00	0.00	0.00	0.00	0.00
	B	1	6.00	57.12	0.15	0.01	2.25	96.08	9.40	0.21	0.12
	Bx	1	16.59	0.00	0.00	0.00	0.00	0.00	0.00	0.00	0.00
	C	1	6.00	38.10	3.57	0.53	58.32	86.21	318.65	15.85	4.19
		2	6.00	26.34	0.01	0.00	0.10	64.85	0.65	0.00	0.01
	Cx	1	16.80	0.00	0.00	0.00	0.00	0.00	0.00	0.00	0.00
	D	1	6.00	66.01	0.49	0.10	8.33	104.41	30.58	2.83	0.42
Dx	1	16.45	0.00	0.00	0.00	0.00	0.00	0.00	0.00	0.00	

Traffic Stream Results: Queues and blocking

Time Segment	Arm	Traffic Stream	Initial queue (Veh)	Mean max queue (Veh)	Max queue storage (Veh)	Utilised storage (%)	Average storage excess queue (Veh)	Average limit excess queue (Veh)	Excess queue penalty (£ per hr)	Wasted time starvation (s (per cycle))	Wasted time blocking back (s (per cycle))	Wasted time total (s (per cycle))	Estimated blocking	
08:00-09:00	A	1	0.00	11.38	8.70	130.84	0.29	0.00	0.00	0.00	0.00	0.00		
	Ax	1	0.00	0.00	23.92	0.00	0.00	0.00	0.00	53.00	0.00	53.00		
	B	1	0.00	0.32	8.70	3.72	0.00	0.00	0.00	5.00	0.00	5.00		
	Bx	1	0.00	0.00	24.05	0.00	0.00	0.00	0.00	120.00	0.00	120.00		
	C	1	0.00	11.31	8.70	130.08	0.28	0.00	0.00	0.00	0.00	0.00	0.00	
		2	0.00	0.00	8.70	0.00	0.00	0.00	0.00	0.00	40.00	0.00	40.00	
	Cx	1	0.00	0.00	24.35	0.00	0.00	0.00	0.00	58.00	0.00	58.00		
	D	1	0.00	1.13	8.70	12.97	0.00	0.00	0.00	0.00	3.00	0.00	3.00	
Dx	1	0.00	0.00	23.84	0.00	0.00	0.00	0.00	0.00	120.00	0.00	120.00		

Pedestrian Crossing Results

Pedestrian Crossings: Pedestrian summary

Time Segment	Crossing	Side	Degree of saturation (%)	Calculated Flow Entering (Ped/hr)	Calculated sat flow (Ped/hr)	Actual green (s (per cycle))	Mean Delay Per Ped (s)	Mean max queue (Ped)	Weighted cost of delay (£ per hr)	Performance Index (£ per hr)
08:00-09:00	(ALL)	(ALL)	7	30	11000	5	55.58	0.96	6.58	6.58

Pedestrian Crossings: Flows and signals

Time Segment	Crossing	Side	Calculated flow entering (Ped/hr)	Calculated flow out (Ped/hr)	Flow discrepancy (Ped/hr)	Adjusted flow warning	Calculated sat flow (Ped/hr)	Calculated capacity (Ped/hr)	Degree of saturation (%)	DOS Threshold exceeded	Practical reserve capacity (%)	Mean modulus of error	Actual green (s (per cycle))
08:00-09:00	(ALL)	(ALL)	30	30	0		11000	458	7		1428	0.00	5

Pedestrian Crossings: Stops and delays

Time Segment	Crossing	Side	Mean Cruise Time per Ped (s)	Mean Delay per Ped (s)	Uniform delay (Ped-hr/hr)	Random plus oversat delay (Ped-hr/hr)	Weighted cost of delay (£ per hr)
08:00-09:00	1	1	5.67	55.58	0.46	0.00	6.58
		2	5.67	55.58	0.46	0.00	6.58
	2	1	6.33	55.58	0.46	0.00	6.58
		2	6.33	55.58	0.46	0.00	6.58
	3	1	6.33	55.58	0.46	0.00	6.58
		2	6.33	55.58	0.46	0.00	6.58
	4	1	5.67	55.58	0.46	0.00	6.58
		2	5.67	55.58	0.46	0.00	6.58

Pedestrian Crossings: Queues and blocking

Time Segment	Crossing	Side	Mean max queue (Ped)	Max queue storage (Ped)	Utilised storage (%)	Average storage excess queue (Ped)	Average limit excess queue (Ped)	Excess queue penalty (£ per hr)
08:00-09:00	(ALL)	(ALL)	0.96	10.00	9.58	0.00	0.00	0.00

Network Results

Network Results: Flows and signals

Time Segment	Calculated flow entering (Veh/hr)	Calculated flow out (Veh/hr)	Flow discrepancy (Veh/hr)	Adjusted flow warning	Degree of saturation (%)	DOS Threshold exceeded	Practical reserve capacity (%)	Actual green (s (per cycle))
08:00-09:00	1882	1882	0		63		58	650

Network Results: Stops and delays

Time Segment	Mean Cruise Time per Veh (s)	Mean Delay per Veh (s)	Uniform delay (Veh-hr/hr)	Random plus oversat delay (Veh-hr/hr)	Weighted cost of delay (£ per hr)	Mean stops per Veh (%)	Uniform stops (Stops per hr)	Random stops (Stops per hr)	Weighted cost of stops (£ per hr)
08:00-09:00	10.64	24.30	11.52	1.18	180.42	37.98	679.76	35.03	8.96

Network Results: Queues and blocking

Time Segment	Utilised storage (%)	Excess queue penalty (£ per hr)	Wasted time starvation (s per cycle)	Wasted time blocking back (s per cycle)	Wasted time total (s per cycle)
08:00-09:00	130.84	0.00	399.00	0.00	399.00

Final Prediction Table

Traffic Stream Results

Arm	Traffic Stream	Name	Traffic node	SIGNALS		FLOWS		PERFORMANCE				PER PCU			QUEUES
				Controller stream	Phase	Calculated flow entering (Veh/hr)	Calculated sat flow (Veh/hr)	Actual green (s per cycle)	Wasted time total (s per cycle)	Degree of saturation (%)	Practical reserve capacity (%)	JourneyTime (s)	Mean Delay per Veh (s)	Mean stops per Veh (%)	Mean max queue (Veh)
A	1	(untitled)	1	1	B	390 <	1800	40	0.00	63	58	44.22	38.22	86.32	11.38 +
Ax	1	(untitled)				407	Unrestricted	120	53.00	0	Unrestricted	16.50	0.00	0.00	0.00
B	1	(untitled)	1	1	C	10	1800	5	5.00	11	800	63.12	57.12	96.08	0.32
Bx	1	(untitled)				6	Unrestricted	120	120.00	0	Unrestricted	16.59	0.00	0.00	0.00
C	1	(untitled)	1	1	A	388 <	1800	40	0.00	63	59	44.10	38.10	86.21	11.31 +
	2	(untitled)	1	1	A	1	1800	40	40.00	0	61400	32.34	26.34	64.85	0.00
Cx	1	(untitled)				392	Unrestricted	120	58.00	0	Unrestricted	16.80	0.00	0.00	0.00
D	1	(untitled)	1	1	D	32	1800	5	3.00	36	181	72.01	66.01	104.41	1.13
Dx	1	(untitled)				16	Unrestricted	120	120.00	0	Unrestricted	16.45	0.00	0.00	0.00

Pedestrian Crossing Results

Pedestrian	Side	Name	Traffic node	SIGNALS		FLOWS		PERFORMANCE			PER PED		QUEUES	WEIGHTS	PEN
				Controller stream	Phase	Calculated Flow Entering (Ped/hr)	Calculated sat flow (Ped/hr)	Actual green (s per cycle)	Degree of saturation (%)	Practical reserve capacity (%)	JourneyTime (s)	Mean Delay per Ped (s)	Mean max queue (Ped)	Delay weighting (%)	Co tra pen (£ p)
1	1	(untitled)	1	1	E	30	11000	5	7	1428	61.25	55.58	0.96	100	0
	2	(untitled)	1	1	E	30	11000	5	7	1428	61.25	55.58	0.96	100	0
2	1	(untitled)	1	1	E	30	11000	5	7	1428	61.92	55.58	0.96	100	0
	2	(untitled)	1	1	E	30	11000	5	7	1428	61.92	55.58	0.96	100	0
3	1	(untitled)	1	1	E	30	11000	5	7	1428	61.92	55.58	0.96	100	0
	2	(untitled)	1	1	E	30	11000	5	7	1428	61.92	55.58	0.96	100	0
4	1	(untitled)	1	1	E	30	11000	5	7	1428	61.25	55.58	0.96	100	0
	2	(untitled)	1	1	E	30	11000	5	7	1428	61.25	55.58	0.96	100	0

Network Results

	Distance travelled (PCU-km/hr)	Time spent (PCU-hr/hr)	Mean journey speed (kph)	Uniform delay (Veh-hr/hr)	Random plus oversat delay (Veh-hr/hr)	Weighted cost of delay (£ per hr)	Weighted cost of stops (£ per hr)	Excess queue penalty (£ per hr)	Performance Index (£ per hr)
Normal traffic	154.93	14.16	10.94	7.82	1.18	127.80	8.96	0.00	136.76
Bus	0.00	0.00	0.00	0.00	0.00	0.00	0.00	0.00	0.00
Tram	0.00	0.00	0.00	0.00	0.00	0.00	0.00	0.00	0.00
Pedestrians	2.04	4.11	0.50	3.71	0.00	52.62	0.00	0.00	52.62
TOTAL	156.97	18.27	8.59	11.52	1.18	180.42	8.96	0.00	189.38

- | < = adjusted flow warning (upstream links/traffic streams are over-saturated)
- | * = Traffic Stream - Normal, Bus or Tram Stop or Delay weighting has been set to a value other than 100%
- | ^ = Traffic Stream - Normal, Bus or Tram Stop or Delay Path weighting has been set to a value other than 100%
- | + = average link/traffic stream excess queue is greater than 0
- | **P.I. = PERFORMANCE INDEX**

A2 - DO NOTHING 2029

D2 - DO NOTHING 2029*

Summary

Data Errors and Warnings

No errors or warnings

Run Summary

Analysis set used	Run start time	Run finish time	Modelling start time (HH:mm)	Network Cycle Time (s)	Performance Index (£ per hr)	Total network delay (Veh-hr/hr)	Highest DOS (%)	Item with highest DOS	Number of oversaturated items	Percentage of oversaturated items (%)	Item with worst signalised PRC	Item with worst unsignalised PRC	Item with worst over PR
2	19/08/2020 12:11:20	19/08/2020 12:11:21	08:00	120	230.76	15.46	73.33	A/1	0	0	A/1	Dx/1	A/

Analysis Set Details

Name	Description	Demand set	Include in report	Locked
DO NOTHING 2029	AM	D2	✓	

Demand Set Details

Name	Description	Composite	Demand sets	Start time (HH:mm)	Locked
DO NOTHING 2029	AM			08:00	

Arms and Traffic Streams

Arms

Arm	Name	Description	Traffic node
A	(untitled)		1
Ax	(untitled)		
B	(untitled)		1
Bx	(untitled)		
C	(untitled)		1
Cx	(untitled)		
D	(untitled)		1
Dx	(untitled)		

Traffic Streams

Arm	Traffic Stream	Name	Description	Auto length	Length (m)	Has Saturation Flow	Saturation flow source	Saturation flow (PCU/hr)	Is signal controlled	Is give way	Traffic type	Allow Nearside Turn On Red
A	1	(untitled)		✓	50.00	✓	Sum of lanes	1800	✓		Normal	
Ax	1	(untitled)		✓	137.53						Normal	
B	1	(untitled)		✓	50.00	✓	Sum of lanes	1800	✓		Normal	
Bx	1	(untitled)		✓	138.27						Normal	
C	1	(untitled)		✓	50.00	✓	Sum of lanes	1800	✓		Normal	
	2	(untitled)		✓	50.00	✓	Sum of lanes	1800	✓		Normal	
Cx	1	(untitled)		✓	140.00						Normal	
D	1	(untitled)		✓	50.00	✓	Sum of lanes	1800	✓		Normal	
Dx	1	(untitled)		✓	137.05						Normal	

Lanes

Arm	Traffic Stream	Lane	Name	Description	Use RR67	Saturation flow (PCU/hr)
A	1	1	(untitled)			1800
Ax	1	1	(untitled)			
B	1	1	(untitled)			1800
Bx	1	1	(untitled)			
C	1	1	(untitled)			1800
	2	1	(untitled)			1800
Cx	1	1	(untitled)			
D	1	1	(untitled)			1800
Dx	1	1	(untitled)			

Modelling

Arm	Traffic Stream	Traffic model	Stop weighting multiplier (%)	Delay weighting multiplier (%)	Assignment Cost Weighting (%)	Exclude from results calculation	Max queue storage (PCU)	Has queue limit	Has degree of saturation limit
(ALL)	(ALL)	NetworkDefault	100	100	100		0.00		

Modelling - Advanced

Arm	Traffic Stream	Initial queue (PCU)	Type of Vehicle-in-Service	Vehicle-in-Service	Type of random parameter	Random parameter	Auto cycle time	Cycle time
(ALL)	(ALL)	0.00	NetworkDefault	Not-Included	NetworkDefault	0.50	✓	120

Normal traffic - Modelling

Arm	Traffic Stream	Stop weighting (%)	Delay weighting (%)
(ALL)	(ALL)	100	100

Normal traffic - Advanced

Arm	Traffic Stream	Dispersion type for Normal Traffic
(ALL)	(ALL)	NetworkDefault

Flows

Arm	Traffic Stream	Total Flow (Veh/hr)	Normal Flow (Veh/hr)
A	1	473	473
Ax	1	460	460
B	1	26	26
Bx	1	48	48
C	1	428	428
	2	10	10
Cx	1	445	445
D	1	32	32
Dx	1	16	16

Signals

Arm	Traffic Stream	Controller stream	Phase	Second phase enabled
A	1	1	B	
B	1	1	C	
C	1	1	A	
	2	1	A	
D	1	1	D	

Pedestrian Crossings

Pedestrian Crossings

Crossing	Name	Description	Traffic node	Allow walk on red	Crossing type	Length (m)	Cruise time (seconds)	Cruise speed (kph)
1	(untitled)		1		Farside	7.00	4.67	5.40
2	(untitled)		1		Farside	8.00	5.33	5.40
3	(untitled)		1		Farside	8.00	5.33	5.40
4	(untitled)		1		Farside	7.00	4.67	5.40

Pedestrian Crossings - Signals

Crossing	Controller stream	Phase	Second phase enabled
(ALL)	1	E	

Pedestrian Crossings - Sides

Crossing	Side	Saturation flow (Ped/hr)
(ALL)	(ALL)	11000

Pedestrian Crossings - Modelling

Crossing	Side	Delay weighting (%)	Assignment Cost Weighting (%)	Exclude from results calculation	Max queue storage (Ped)	Has queue limit	Has degree of saturation limit
(ALL)	(ALL)	100	100		0.00		

Local OD Matrix - Local Matrix: 1

Local Matrix Options

OD Matrix	Name	Use for point to point table	Auto calculate	Allocation mode	Allow paths past exit locations	Allow looped paths on arms	Allow looped paths on traffic nodes	Copy flows	Matrix to copy flows from	Limit paths by length	Path length limit multiplier	Limit paths by number	Path number limit
1	(untitled)	✓	✓	Path Equalisation	✓		✓			✓	1.25		

Normal Input Flows (Veh/hr)

	To								
	1	2	3	4	5	6	7	8	
From	1	0	7	421	10	0	0	0	0
	2	14	0	18	0	0	0	0	0
	3	426	9	0	38	0	0	0	0
	4	5	0	21	0	0	0	0	0
	5	0	0	0	0	0	0	0	0
	6	0	0	0	0	0	0	0	0
	7	0	0	0	0	0	0	0	0
	8	0	0	0	0	0	0	0	0

Bus Input Flows not shown as they are blank.

Tram Input Flows not shown as they are blank.

Pedestrian Input Flows (Veh/hr)

From	To							
	1	2	3	4	5	6	7	8
1	0	0	0	0	0	0	0	0
2	0	0	0	0	0	0	0	0
3	0	0	0	0	0	0	0	0
4	0	0	0	0	0	0	0	0
5	0	0	0	0	0	30	30	0
6	0	0	0	0	30	0	0	30
7	0	0	0	0	30	0	0	30
8	0	0	0	0	0	30	30	0

Locations

OD Matrix	Location	Name	Entries	Exits	Colour
1	1	(untitled)	C/1, C/2	Cx/1	#0000FF
	2	(untitled)	D/1	Dx/1	#FF0000
	3	(untitled)	A/1	Ax/1	#00FF00
	4	(untitled)	B/1	Bx/1	#FFFF00
	5	(untitled)	3:2E, 1:1E	3:2X, 1:1X	#FF00FF
	6	(untitled)	2:1E, 1:2E	2:1X, 1:2X	#008000
	7	(untitled)	4:2E, 3:1E	4:2X, 3:1X	#FFA500
	8	(untitled)	4:1E, 2:2E	4:1X, 2:2X	#00FFFF

Normal Paths and Flows

OD Matrix	Path	Description	From location	To location	Path items	Allocation type	Normal Calculated Flow (Veh/hr)
1	1		1	2	C/1, Dx/1	Normal	7
	2		1	3	C/1, Ax/1	Normal	421
	5		2	3	D/1, Ax/1	Normal	18
	6		2	4	D/1, Bx/1	Normal	0
	7		2	1	D/1, Cx/1	Normal	14
	8		3	2	A/1, Dx/1	Normal	9
	9		3	4	A/1, Bx/1	Normal	38
	10		3	1	A/1, Cx/1	Normal	426
	11		4	2	B/1, Dx/1	Normal	0
	12		4	3	B/1, Ax/1	Normal	21
	13		4	1	B/1, Cx/1	Normal	5
	21		1	4	C/2, Bx/1	Normal	10

Pedestrian Paths and Flows

OD Matrix	Path	Description	From location	To location	Path items	Allocation type	Pedestrian calculated flow (Ped/hr)
1	17		8	7	4:1E, 4:2X	Normal	30
	18		8	6	2:2E, 2:1X	Normal	30
	22		5	7	3:2E, 3:1X	Normal	30
	23		5	6	1:1E, 1:2X	Normal	30
	34		6	8	2:1E, 2:2X	Normal	30
	35		6	5	1:2E, 1:1X	Normal	30
	41		7	8	4:2E, 4:1X	Normal	30
	42		7	5	3:1E, 3:2X	Normal	30

Signal Timings

Network Default: 120s cycle time; 120 steps

Controller Stream 1

Controller Stream	Name	Description	Use sequence	Cycle time source	Cycle time (s)
1	(untitled)		1	NetworkDefault	120

Controller Stream 1 - Properties

Controller Stream	Manufacturer name	Type	Model number	(Telephone) Line Number	Site number	Grid reference	Gaining delay type
1	Unspecified						Relative

Controller Stream 1 - Optimisation

Controller Stream	Allow offset optimisation	Allow green split optimisation	Optimisation level	Auto redistribute	Enable stage constraint
1	✓	✓	Offsets And Green Splits	✓	

Phases

Controller Stream	Phase	Name	Minimum green (s)	Maximum green (s)	Relative start displacement (s)	Relative end displacement (s)	Type	Blackout Time (s)
1	A	(untitled)	38	300	0	0	Traffic	
	B	(untitled)	5	300	0	0	Traffic	
	C	(untitled)	5	300	0	0	Traffic	
	D	(untitled)	5	300	0	0	Traffic	
	E	(untitled)	5	300	0	0	Pedestrian	0

Library Stages

Controller Stream	Library Stage	Phases in stage	User stage minimum (s)
1	1	A	1
	2	B	1
	3	C	1
	4	D	1
	5	E	1

Stage Sequences

Controller Stream	Sequence	Name	Multiple cycling	Stage IDs	Stage ends
1	1	(untitled)	Single	1, 2, 3, 4, 5	29, 76, 86, 96, 106

Intergreen Matrix for Controller Stream 1

		To				
		A	B	C	D	E
From	A		5	5	5	5
	B	5		5	5	5
	C	5	5		5	5
	D	5	5	5		5
	E	5	5	5	5	

Banned Stage transitions for Controller Stream 1

		To				
		1	2	3	4	5
From	1					
	2					
	3					
	4					
	5					

Interstage Matrix for Controller Stream 1

		To				
		1	2	3	4	5
From	1	0	5	5	5	5
	2	5	0	5	5	5
	3	5	5	0	5	5
	4	5	5	5	0	5
	5	5	5	5	5	0

Resultant Stages

Controller Stream	Resultant Stage	Is base stage	Library Stage ID	Phases in this stage	Stage start (s)	Stage end (s)	Stage duration (s)	User stage minimum (s)	Stage minimum (s)
1	1	✓	1	A	111	29	38	1	38
	2	✓	2	B	34	76	42	1	5
	3	✓	3	C	81	86	5	1	5
	4	✓	4	D	91	96	5	1	5
	5	✓	5	E	101	106	5	1	5

Resultant Phase Green Periods

Controller Stream	Phase	Green period	Is base green period	Start time (s)	End time (s)	Duration (s)
1	A	1	✓	111	29	38
	B	1	✓	34	76	42
	C	1	✓	81	86	5
	D	1	✓	91	96	5
	E	1	✓	101	106	5

Traffic Stream Green Times

Arm	Traffic Stream	Traffic Node	Controller Stream	Phase	Green Period 1		
					Start	End	Duration
A	1	1	1	B	34	76	42
B	1	1	1	C	81	86	5
C	1	1	1	A	111	29	38
C	2	1	1	A	111	29	38
D	1	1	1	D	91	96	5

Phase Timings Diagram for Controller Stream 1

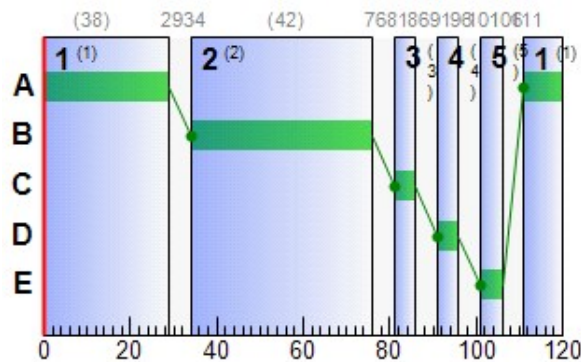

Stage Sequence Diagram for Controller Stream 1

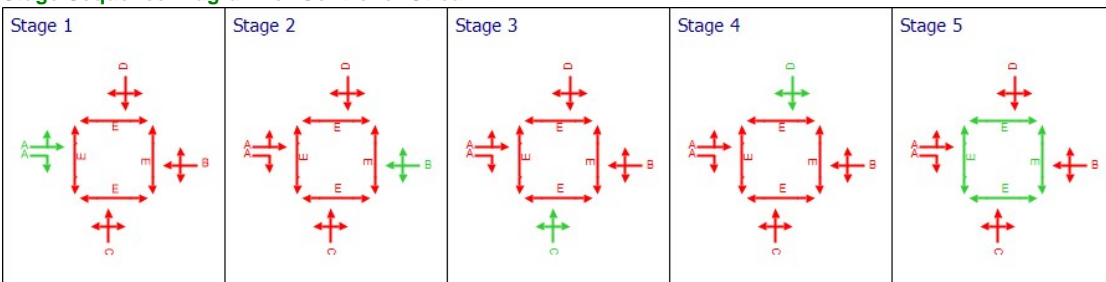

Resultant penalties

Time Segment	Controller stream	Phase min max penalty (£ per hr)	Intergreen broken penalty (£ per hr)	Stage constraint broken penalty (£ per hr)	Cost of controller stream penalties (£ per hr)
08:00-09:00	1	0.00	0.00	0.00	0.00

Traffic Stream Results

Traffic Stream Results: Vehicle summary

Time Segment	Arm	Traffic Stream	Degree of saturation (%)	Practical reserve capacity (%)	Calculated flow entering (Veh/hr)	Calculated sat flow (Veh/hr)	Actual green (s per cycle)	Mean Delay per Veh (s)	Mean max queue (Veh)	Utilised storage (%)	Weighted cost of delay (£ per hr)	Weighted cost of stops (£ per hr)	Performance Index (£ per hr)
08:00-09:00	A	1	73	36	473	1800	42	41.04	14.65	168.51	76.56	5.42	81.98
	Ax	1	0	Unrestricted	460	Unrestricted	120	0.00	0.00	0.00	0.00	0.00	0.00
	B	1	29	246	26	1800	5	63.04	0.89	10.22	6.47	0.33	6.80
	Bx	1	0	Unrestricted	48	Unrestricted	120	0.00	0.00	0.00	0.00	0.00	0.00
	C	1	73	37	428	1800	38	44.08	13.58	156.15	74.41	5.02	79.43
		2	2	5750	10	1800	38	27.73	0.23	2.59	1.09	0.08	1.18
	Cx	1	0	Unrestricted	445	Unrestricted	120	0.00	0.00	0.00	0.00	0.00	0.00
	D	1	36	181	32	1800	5	66.01	1.13	12.97	8.33	0.42	8.75
Dx	1	0	Unrestricted	16	Unrestricted	120	0.00	0.00	0.00	0.00	0.00	0.00	

Traffic Stream Results: Flows and signals

Time Segment	Arm	Traffic Stream	Calculated flow entering (Veh/hr)	Calculated flow out (Veh/hr)	Flow discrepancy (Veh/hr)	Adjusted flow warning	Calculated sat flow (Veh/hr)	Calculated capacity (Veh/hr)	Degree of saturation (%)	DOS Threshold exceeded	Practical reserve capacity (%)	Mean modulus of error	Actual green (s per cycle)
08:00-09:00	A	1	473	473	0		1800	645	73		36	0.00	42
	Ax	1	460	460	0		Unrestricted	Unrestricted	0		Unrestricted	1.10	120
	B	1	26	26	0		1800	90	29		246	0.00	5
	Bx	1	48	48	0		Unrestricted	Unrestricted	0		Unrestricted	0.92	120
	C	1	428	428	0		1800	585	73		37	0.00	38
		2	10	10	0		1800	585	2		5750	0.00	38
	Cx	1	445	445	0		Unrestricted	Unrestricted	0		Unrestricted	1.12	120
	D	1	32	32	0		1800	90	36		181	0.00	5
Dx	1	16	16	0		Unrestricted	Unrestricted	0		Unrestricted	0.68	120	

Traffic Stream Results: Stops and delays

Time Segment	Arm	Traffic Stream	Mean Cruise Time per Veh (s)	Mean Delay per Veh (s)	Uniform delay (Veh-hr/hr)	Random plus oversat delay (Veh-hr/hr)	Weighted cost of delay (£ per hr)	Mean stops per Veh (%)	Uniform stops (Stops per hr)	Random stops (Stops per hr)	Weighted cost of stops (£ per hr)
08:00-09:00	A	1	6.00	41.04	4.40	0.99	76.56	91.40	403.11	29.20	5.42
	Ax	1	16.50	0.00	0.00	0.00	0.00	0.00	0.00	0.00	0.00
	B	1	6.00	63.04	0.40	0.06	6.47	101.44	24.66	1.71	0.33
	Bx	1	16.59	0.00	0.00	0.00	0.00	0.00	0.00	0.00	0.00
	C	1	6.00	44.08	4.26	0.98	74.41	93.52	371.49	28.79	5.02
		2	6.00	27.73	0.08	0.00	1.09	66.56	6.65	0.00	0.08
	Cx	1	16.80	0.00	0.00	0.00	0.00	0.00	0.00	0.00	0.00
	D	1	6.00	66.01	0.49	0.10	8.33	104.41	30.58	2.83	0.42
Dx	1	16.45	0.00	0.00	0.00	0.00	0.00	0.00	0.00	0.00	

Traffic Stream Results: Queues and blocking

Time Segment	Arm	Traffic Stream	Initial queue (Veh)	Mean max queue (Veh)	Max queue storage (Veh)	Utilised storage (%)	Average storage excess queue (Veh)	Average limit excess queue (Veh)	Excess queue penalty (£ per hr)	Wasted time starvation (s (per cycle))	Wasted time blocking back (s (per cycle))	Wasted time total (s (per cycle))	Estimated blocking	
08:00-09:00	A	1	0.00	14.65	8.70	168.51	1.15	0.00	0.00	0.00	0.00	0.00		
	Ax	1	0.00	0.00	23.92	0.00	0.00	0.00	0.00	50.00	0.00	50.00		
	B	1	0.00	0.89	8.70	10.22	0.00	0.00	0.00	4.00	0.00	4.00		
	Bx	1	0.00	0.00	24.05	0.00	0.00	0.00	0.00	81.00	0.00	81.00		
	C	1	0.00	13.58	8.70	156.15	0.86	0.00	0.00	0.00	0.00	0.00	0.00	
		2	0.00	0.23	8.70	2.59	0.00	0.00	0.00	0.00	38.00	0.00	38.00	
	Cx	1	0.00	0.00	24.35	0.00	0.00	0.00	0.00	54.00	0.00	54.00		
	D	1	0.00	1.13	8.70	12.97	0.00	0.00	0.00	0.00	3.00	0.00	3.00	
Dx	1	0.00	0.00	23.84	0.00	0.00	0.00	0.00	0.00	120.00	0.00	120.00		

Pedestrian Crossing Results

Pedestrian Crossings: Pedestrian summary

Time Segment	Crossing	Side	Degree of saturation (%)	Calculated Flow Entering (Ped/hr)	Calculated sat flow (Ped/hr)	Actual green (s (per cycle))	Mean Delay Per Ped (s)	Mean max queue (Ped)	Weighted cost of delay (£ per hr)	Performance Index (£ per hr)
08:00-09:00	(ALL)	(ALL)	7	30	11000	5	55.58	0.96	6.58	6.58

Pedestrian Crossings: Flows and signals

Time Segment	Crossing	Side	Calculated flow entering (Ped/hr)	Calculated flow out (Ped/hr)	Flow discrepancy (Ped/hr)	Adjusted flow warning	Calculated sat flow (Ped/hr)	Calculated capacity (Ped/hr)	Degree of saturation (%)	DOS Threshold exceeded	Practical reserve capacity (%)	Mean modulus of error	Actual green (s (per cycle))
08:00-09:00	(ALL)	(ALL)	30	30	0		11000	458	7		1428	0.00	5

Pedestrian Crossings: Stops and delays

Time Segment	Crossing	Side	Mean Cruise Time per Ped (s)	Mean Delay per Ped (s)	Uniform delay (Ped-hr/hr)	Random plus oversat delay (Ped-hr/hr)	Weighted cost of delay (£ per hr)
08:00-09:00	1	1	5.67	55.58	0.46	0.00	6.58
		2	5.67	55.58	0.46	0.00	6.58
	2	1	6.33	55.58	0.46	0.00	6.58
		2	6.33	55.58	0.46	0.00	6.58
	3	1	6.33	55.58	0.46	0.00	6.58
		2	6.33	55.58	0.46	0.00	6.58
	4	1	5.67	55.58	0.46	0.00	6.58
		2	5.67	55.58	0.46	0.00	6.58

Pedestrian Crossings: Queues and blocking

Time Segment	Crossing	Side	Mean max queue (Ped)	Max queue storage (Ped)	Utilised storage (%)	Average storage excess queue (Ped)	Average limit excess queue (Ped)	Excess queue penalty (£ per hr)
08:00-09:00	(ALL)	(ALL)	0.96	10.00	9.58	0.00	0.00	0.00

Network Results

Network Results: Flows and signals

Time Segment	Calculated flow entering (Veh/hr)	Calculated flow out (Veh/hr)	Flow discrepancy (Veh/hr)	Adjusted flow warning	Degree of saturation (%)	DOS Threshold exceeded	Practical reserve capacity (%)	Actual green (s (per cycle))
08:00-09:00	2178	2178	0		73		36	648

Network Results: Stops and delays

Time Segment	Mean Cruise Time per Veh (s)	Mean Delay per Veh (s)	Uniform delay (Veh-hr/hr)	Random plus oversat delay (Veh-hr/hr)	Weighted cost of delay (£ per hr)	Mean stops per Veh (%)	Uniform stops (Stops per hr)	Random stops (Stops per hr)	Weighted cost of stops (£ per hr)
08:00-09:00	10.74	25.55	13.34	2.12	219.49	41.28	836.49	62.53	11.27

Network Results: Queues and blocking

Time Segment	Utilised storage (%)	Excess queue penalty (£ per hr)	Wasted time starvation (s per cycle)	Wasted time blocking back (s per cycle)	Wasted time total (s per cycle)
08:00-09:00	168.51	0.00	350.00	0.00	350.00

Final Prediction Table

Traffic Stream Results

Arm	Traffic Stream	Name	Traffic node	SIGNALS		FLOWS		PERFORMANCE				PER PCU			QUEUES
				Controller stream	Phase	Calculated flow entering (Veh/hr)	Calculated sat flow (Veh/hr)	Actual green (s per cycle)	Wasted time total (s per cycle)	Degree of saturation (%)	Practical reserve capacity (%)	JourneyTime (s)	Mean Delay per Veh (s)	Mean stops per Veh (%)	Mean max queue (Veh)
A	1	(untitled)	1	1	B	473 <	1800	42	0.00	73	36	47.04	41.04	91.40	14.65 +
Ax	1	(untitled)				460	Unrestricted	120	50.00	0	Unrestricted	16.50	0.00	0.00	0.00
B	1	(untitled)	1	1	C	26	1800	5	4.00	29	246	69.04	63.04	101.44	0.89
Bx	1	(untitled)				48	Unrestricted	120	81.00	0	Unrestricted	16.59	0.00	0.00	0.00
C	1	(untitled)	1	1	A	428 <	1800	38	0.00	73	37	50.08	44.08	93.52	13.58 +
	2	(untitled)	1	1	A	10	1800	38	38.00	2	5750	33.73	27.73	66.56	0.23
Cx	1	(untitled)				445	Unrestricted	120	54.00	0	Unrestricted	16.80	0.00	0.00	0.00
D	1	(untitled)	1	1	D	32	1800	5	3.00	36	181	72.01	66.01	104.41	1.13
Dx	1	(untitled)				16	Unrestricted	120	120.00	0	Unrestricted	16.45	0.00	0.00	0.00

Pedestrian Crossing Results

Pedestrian	Side	Name	Traffic node	SIGNALS		FLOWS		PERFORMANCE			PER PED		QUEUES	WEIGHTS	PEN
				Controller stream	Phase	Calculated Flow Entering (Ped/hr)	Calculated sat flow (Ped/hr)	Actual green (s per cycle)	Degree of saturation (%)	Practical reserve capacity (%)	JourneyTime (s)	Mean Delay per Ped (s)	Mean max queue (Ped)	Delay weighting (%)	Co tra pen (£ p)
1	1	(untitled)	1	1	E	30	11000	5	7	1428	61.25	55.58	0.96	100	0
	2	(untitled)	1	1	E	30	11000	5	7	1428	61.25	55.58	0.96	100	0
2	1	(untitled)	1	1	E	30	11000	5	7	1428	61.92	55.58	0.96	100	0
	2	(untitled)	1	1	E	30	11000	5	7	1428	61.92	55.58	0.96	100	0
3	1	(untitled)	1	1	E	30	11000	5	7	1428	61.92	55.58	0.96	100	0
	2	(untitled)	1	1	E	30	11000	5	7	1428	61.92	55.58	0.96	100	0
4	1	(untitled)	1	1	E	30	11000	5	7	1428	61.25	55.58	0.96	100	0
	2	(untitled)	1	1	E	30	11000	5	7	1428	61.25	55.58	0.96	100	0

Network Results

	Distance travelled (PCU-km/hr)	Time spent (PCU-hr/hr)	Mean journey speed (kph)	Uniform delay (Veh-hr/hr)	Random plus oversat delay (Veh-hr/hr)	Weighted cost of delay (£ per hr)	Weighted cost of stops (£ per hr)	Excess queue penalty (£ per hr)	Performance Index (£ per hr)
Normal traffic	182.84	17.85	10.25	9.63	2.12	166.87	11.27	0.00	178.14
Bus	0.00	0.00	0.00	0.00	0.00	0.00	0.00	0.00	0.00
Tram	0.00	0.00	0.00	0.00	0.00	0.00	0.00	0.00	0.00
Pedestrians	2.04	4.11	0.50	3.71	0.00	52.62	0.00	0.00	52.62
TOTAL	184.88	21.95	8.42	13.34	2.12	219.49	11.27	0.00	230.76

- | < = adjusted flow warning (upstream links/traffic streams are over-saturated)
- | * = Traffic Stream - Normal, Bus or Tram Stop or Delay weighting has been set to a value other than 100%
- | ^ = Traffic Stream - Normal, Bus or Tram Stop or Delay Path weighting has been set to a value other than 100%
- | + = average link/traffic stream excess queue is greater than 0
- | **P.I. = PERFORMANCE INDEX**

A3 - DO NOTHING 2039 D3 - DO NOTHING 2039*

Summary

Data Errors and Warnings

No errors or warnings

Run Summary

Analysis set used	Run start time	Run finish time	Modelling start time (HH:mm)	Network Cycle Time (s)	Performance Index (£ per hr)	Total network delay (Veh-hr/hr)	Highest DOS (%)	Item with highest DOS	Number of oversaturated items	Percentage of oversaturated items (%)	Item with worst signalised PRC	Item with worst unsignalised PRC	Item with worst over PR
3	19/08/2020 12:11:21	19/08/2020 12:11:22	08:00	120	254.48	17.04	78.46	C/1	0	0	C/1	Dx/1	C/

Analysis Set Details

Name	Description	Demand set	Include in report	Locked
DO NOTHING 2039	AM	D3	✓	

Demand Set Details

Name	Description	Composite	Demand sets	Start time (HH:mm)	Locked
DO NOTHING 2039	AM			08:00	

Arms and Traffic Streams

Arms

Arm	Name	Description	Traffic node
A	(untitled)		1
Ax	(untitled)		
B	(untitled)		1
Bx	(untitled)		
C	(untitled)		1
Cx	(untitled)		
D	(untitled)		1
Dx	(untitled)		

Traffic Streams

Arm	Traffic Stream	Name	Description	Auto length	Length (m)	Has Saturation Flow	Saturation flow source	Saturation flow (PCU/hr)	Is signal controlled	Is give way	Traffic type	Allow Nearside Turn On Red
A	1	(untitled)		✓	50.00	✓	Sum of lanes	1800	✓		Normal	
Ax	1	(untitled)		✓	137.53						Normal	
B	1	(untitled)		✓	50.00	✓	Sum of lanes	1800	✓		Normal	
Bx	1	(untitled)		✓	138.27						Normal	
C	1	(untitled)		✓	50.00	✓	Sum of lanes	1800	✓		Normal	
	2	(untitled)		✓	50.00	✓	Sum of lanes	1800	✓		Normal	
Cx	1	(untitled)		✓	140.00						Normal	
D	1	(untitled)		✓	50.00	✓	Sum of lanes	1800	✓		Normal	
Dx	1	(untitled)		✓	137.05						Normal	

Lanes

Arm	Traffic Stream	Lane	Name	Description	Use RR67	Saturation flow (PCU/hr)
A	1	1	(untitled)			1800
Ax	1	1	(untitled)			
B	1	1	(untitled)			1800
Bx	1	1	(untitled)			
C	1	1	(untitled)			1800
	2	1	(untitled)			1800
Cx	1	1	(untitled)			
D	1	1	(untitled)			1800
Dx	1	1	(untitled)			

Modelling

Arm	Traffic Stream	Traffic model	Stop weighting multiplier (%)	Delay weighting multiplier (%)	Assignment Cost Weighting (%)	Exclude from results calculation	Max queue storage (PCU)	Has queue limit	Has degree of saturation limit
(ALL)	(ALL)	NetworkDefault	100	100	100		0.00		

Modelling - Advanced

Arm	Traffic Stream	Initial queue (PCU)	Type of Vehicle-in-Service	Vehicle-in-Service	Type of random parameter	Random parameter	Auto cycle time	Cycle time
(ALL)	(ALL)	0.00	NetworkDefault	Not-Included	NetworkDefault	0.50	✓	120

Normal traffic - Modelling

Arm	Traffic Stream	Stop weighting (%)	Delay weighting (%)
(ALL)	(ALL)	100	100

Normal traffic - Advanced

Arm	Traffic Stream	Dispersion type for Normal Traffic
(ALL)	(ALL)	NetworkDefault

Flows

Arm	Traffic Stream	Total Flow (Veh/hr)	Normal Flow (Veh/hr)
A	1	504	504
Ax	1	491	491
B	1	26	26
Bx	1	48	48
C	1	459	459
	2	10	10
Cx	1	476	476
D	1	32	32
Dx	1	16	16

Signals

Arm	Traffic Stream	Controller stream	Phase	Second phase enabled
A	1	1	B	
B	1	1	C	
C	1	1	A	
	2	1	A	
D	1	1	D	

Pedestrian Crossings

Pedestrian Crossings

Crossing	Name	Description	Traffic node	Allow walk on red	Crossing type	Length (m)	Cruise time (seconds)	Cruise speed (kph)
1	(untitled)		1		Farside	7.00	4.67	5.40
2	(untitled)		1		Farside	8.00	5.33	5.40
3	(untitled)		1		Farside	8.00	5.33	5.40
4	(untitled)		1		Farside	7.00	4.67	5.40

Pedestrian Crossings - Signals

Crossing	Controller stream	Phase	Second phase enabled
(ALL)	1	E	

Pedestrian Crossings - Sides

Crossing	Side	Saturation flow (Ped/hr)
(ALL)	(ALL)	11000

Pedestrian Crossings - Modelling

Crossing	Side	Delay weighting (%)	Assignment Cost Weighting (%)	Exclude from results calculation	Max queue storage (Ped)	Has queue limit	Has degree of saturation limit
(ALL)	(ALL)	100	100		0.00		

Local OD Matrix - Local Matrix: 1

Local Matrix Options

OD Matrix	Name	Use for point to point table	Auto calculate	Allocation mode	Allow paths past exit locations	Allow looped paths on arms	Allow looped paths on traffic nodes	Copy flows	Matrix to copy flows from	Limit paths by length	Path length limit multiplier	Limit paths by number	Path number limit
1	(untitled)	✓	✓	Path Equalisation	✓		✓			✓	1.25		

Normal Input Flows (Veh/hr)

		To							
		1	2	3	4	5	6	7	8
From	1	0	7	452	10	0	0	0	0
	2	14	0	18	0	0	0	0	0
	3	457	9	0	38	0	0	0	0
	4	5	0	21	0	0	0	0	0
	5	0	0	0	0	0	0	0	0
	6	0	0	0	0	0	0	0	0
	7	0	0	0	0	0	0	0	0
	8	0	0	0	0	0	0	0	0

Bus Input Flows not shown as they are blank.

Tram Input Flows not shown as they are blank.

Pedestrian Input Flows (Veh/hr)

From	To							
	1	2	3	4	5	6	7	8
1	0	0	0	0	0	0	0	0
2	0	0	0	0	0	0	0	0
3	0	0	0	0	0	0	0	0
4	0	0	0	0	0	0	0	0
5	0	0	0	0	0	30	30	0
6	0	0	0	0	30	0	0	30
7	0	0	0	0	30	0	0	30
8	0	0	0	0	0	30	30	0

Locations

OD Matrix	Location	Name	Entries	Exits	Colour
1	1	(untitled)	C/1, C/2	Cx/1	#0000FF
	2	(untitled)	D/1	Dx/1	#FF0000
	3	(untitled)	A/1	Ax/1	#00FF00
	4	(untitled)	B/1	Bx/1	#FFFF00
	5	(untitled)	3:2E, 1:1E	3:2X, 1:1X	#FF00FF
	6	(untitled)	2:1E, 1:2E	2:1X, 1:2X	#008000
	7	(untitled)	4:2E, 3:1E	4:2X, 3:1X	#FFA500
	8	(untitled)	4:1E, 2:2E	4:1X, 2:2X	#00FFFF

Normal Paths and Flows

OD Matrix	Path	Description	From location	To location	Path items	Allocation type	Normal Calculated Flow (Veh/hr)
1	1		1	2	C/1, Dx/1	Normal	7
	2		1	3	C/1, Ax/1	Normal	452
	5		2	3	D/1, Ax/1	Normal	18
	6		2	4	D/1, Bx/1	Normal	0
	7		2	1	D/1, Cx/1	Normal	14
	8		3	2	A/1, Dx/1	Normal	9
	9		3	4	A/1, Bx/1	Normal	38
	10		3	1	A/1, Cx/1	Normal	457
	11		4	2	B/1, Dx/1	Normal	0
	12		4	3	B/1, Ax/1	Normal	21
	13		4	1	B/1, Cx/1	Normal	5
	21		1	4	C/2, Bx/1	Normal	10

Pedestrian Paths and Flows

OD Matrix	Path	Description	From location	To location	Path items	Allocation type	Pedestrian calculated flow (Ped/hr)
1	17		8	7	4:1E, 4:2X	Normal	30
	18		8	6	2:2E, 2:1X	Normal	30
	22		5	7	3:2E, 3:1X	Normal	30
	23		5	6	1:1E, 1:2X	Normal	30
	34		6	8	2:1E, 2:2X	Normal	30
	35		6	5	1:2E, 1:1X	Normal	30
	41		7	8	4:2E, 4:1X	Normal	30
	42		7	5	3:1E, 3:2X	Normal	30

Signal Timings

Network Default: 120s cycle time; 120 steps

Controller Stream 1

Controller Stream	Name	Description	Use sequence	Cycle time source	Cycle time (s)
1	(untitled)		1	NetworkDefault	120

Controller Stream 1 - Properties

Controller Stream	Manufacturer name	Type	Model number	(Telephone) Line Number	Site number	Grid reference	Gaining delay type
1	Unspecified						Relative

Controller Stream 1 - Optimisation

Controller Stream	Allow offset optimisation	Allow green split optimisation	Optimisation level	Auto redistribute	Enable stage constraint
1	✓	✓	Offsets And Green Splits	✓	

Phases

Controller Stream	Phase	Name	Minimum green (s)	Maximum green (s)	Relative start displacement (s)	Relative end displacement (s)	Type	Blackout Time (s)
1	A	(untitled)	38	300	0	0	Traffic	
	B	(untitled)	5	300	0	0	Traffic	
	C	(untitled)	5	300	0	0	Traffic	
	D	(untitled)	5	300	0	0	Traffic	
	E	(untitled)	5	300	0	0	Pedestrian	0

Library Stages

Controller Stream	Library Stage	Phases in stage	User stage minimum (s)
1	1	A	1
	2	B	1
	3	C	1
	4	D	1
	5	E	1

Stage Sequences

Controller Stream	Sequence	Name	Multiple cycling	Stage IDs	Stage ends
1	1	(untitled)	Single	1, 2, 3, 4, 5	29, 76, 86, 96, 106

Intergreen Matrix for Controller Stream 1

		To				
		A	B	C	D	E
From	A		5	5	5	5
	B	5		5	5	5
	C	5	5		5	5
	D	5	5	5		5
	E	5	5	5	5	

Banned Stage transitions for Controller Stream 1

		To				
		1	2	3	4	5
From	1					
	2					
	3					
	4					
	5					

Interstage Matrix for Controller Stream 1

		To				
		1	2	3	4	5
From	1	0	5	5	5	5
	2	5	0	5	5	5
	3	5	5	0	5	5
	4	5	5	5	0	5
	5	5	5	5	5	0

Resultant Stages

Controller Stream	Resultant Stage	Is base stage	Library Stage ID	Phases in this stage	Stage start (s)	Stage end (s)	Stage duration (s)	User stage minimum (s)	Stage minimum (s)
1	1	✓	1	A	111	29	38	1	38
	2	✓	2	B	34	76	42	1	5
	3	✓	3	C	81	86	5	1	5
	4	✓	4	D	91	96	5	1	5
	5	✓	5	E	101	106	5	1	5

Resultant Phase Green Periods

Controller Stream	Phase	Green period	Is base green period	Start time (s)	End time (s)	Duration (s)
1	A	1	✓	111	29	38
	B	1	✓	34	76	42
	C	1	✓	81	86	5
	D	1	✓	91	96	5
	E	1	✓	101	106	5

Traffic Stream Green Times

Arm	Traffic Stream	Traffic Node	Controller Stream	Phase	Green Period 1		
					Start	End	Duration
A	1	1	1	B	34	76	42
B	1	1	1	C	81	86	5
C	1	1	1	A	111	29	38
C	2	1	1	A	111	29	38
D	1	1	1	D	91	96	5

Phase Timings Diagram for Controller Stream 1

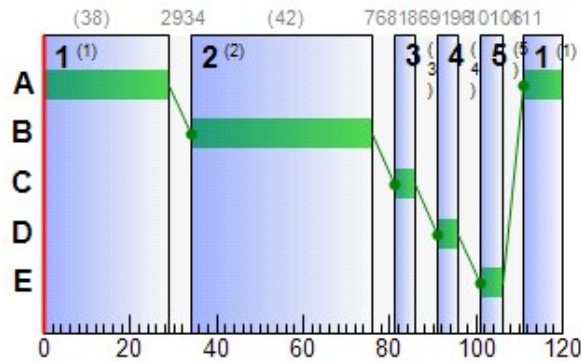

Stage Sequence Diagram for Controller Stream 1

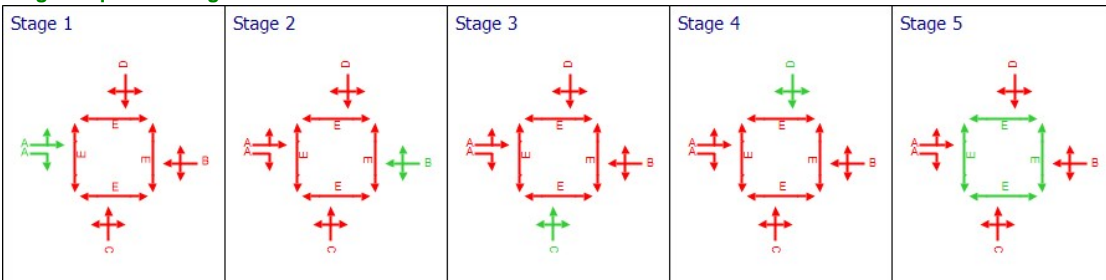

Resultant penalties

Time Segment	Controller stream	Phase min max penalty (£ per hr)	Intergreen broken penalty (£ per hr)	Stage constraint broken penalty (£ per hr)	Cost of controller stream penalties (£ per hr)
08:00-09:00	1	0.00	0.00	0.00	0.00

Traffic Stream Results

Traffic Stream Results: Vehicle summary

Time Segment	Arm	Traffic Stream	Degree of saturation (%)	Practical reserve capacity (%)	Calculated flow entering (Veh/hr)	Calculated sat flow (Veh/hr)	Actual green (s (per cycle))	Mean Delay per Veh (s)	Mean max queue (Veh)	Utilised storage (%)	Weighted cost of delay (£ per hr)	Weighted cost of stops (£ per hr)	Performance Index (£ per hr)
08:00-09:00	A	1	78	28	504	1800	42	43.99	16.20	186.25	87.46	6.00	93.46
	Ax	1	0	Unrestricted	491	Unrestricted	120	0.00	0.00	0.00	0.00	0.00	0.00
	B	1	29	246	26	1800	5	63.04	0.89	10.22	6.47	0.33	6.80
	Bx	1	0	Unrestricted	48	Unrestricted	120	0.00	0.00	0.00	0.00	0.00	0.00
	C	1	78	27	459	1800	38	47.53	15.15	174.24	86.06	5.61	91.67
		2	2	5750	10	1800	38	27.73	0.23	2.59	1.09	0.08	1.18
	Cx	1	0	Unrestricted	476	Unrestricted	120	0.00	0.00	0.00	0.00	0.00	0.00
	D	1	36	181	32	1800	5	66.01	1.13	12.97	8.33	0.42	8.75
Dx	1	0	Unrestricted	16	Unrestricted	120	0.00	0.00	0.00	0.00	0.00	0.00	

Traffic Stream Results: Flows and signals

Time Segment	Arm	Traffic Stream	Calculated flow entering (Veh/hr)	Calculated flow out (Veh/hr)	Flow discrepancy (Veh/hr)	Adjusted flow warning	Calculated sat flow (Veh/hr)	Calculated capacity (Veh/hr)	Degree of saturation (%)	DOS Threshold exceeded	Practical reserve capacity (%)	Mean modulus of error	Actual green (s (per cycle))
08:00-09:00	A	1	504	504	0		1800	645	78		28	0.00	42
	Ax	1	491	491	0		Unrestricted	Unrestricted	0		Unrestricted	1.11	120
	B	1	26	26	0		1800	90	29		246	0.00	5
	Bx	1	48	48	0		Unrestricted	Unrestricted	0		Unrestricted	0.91	120
	C	1	459	459	0		1800	585	78		27	0.00	38
		2	10	10	0		1800	585	2		5750	0.00	38
	Cx	1	476	476	0		Unrestricted	Unrestricted	0		Unrestricted	1.12	120
	D	1	32	32	0		1800	90	36		181	0.00	5
Dx	1	16	16	0		Unrestricted	Unrestricted	0		Unrestricted	0.65	120	

Traffic Stream Results: Stops and delays

Time Segment	Arm	Traffic Stream	Mean Cruise Time per Veh (s)	Mean Delay per Veh (s)	Uniform delay (Veh-hr/hr)	Random plus oversat delay (Veh-hr/hr)	Weighted cost of delay (£ per hr)	Mean stops per Veh (%)	Uniform stops (Stops per hr)	Random stops (Stops per hr)	Weighted cost of stops (£ per hr)
08:00-09:00	A	1	6.00	43.99	4.80	1.36	87.46	94.98	438.86	39.86	6.00
	Ax	1	16.50	0.00	0.00	0.00	0.00	0.00	0.00	0.00	0.00
	B	1	6.00	63.04	0.40	0.06	6.47	101.44	24.66	1.71	0.33
	Bx	1	16.59	0.00	0.00	0.00	0.00	0.00	0.00	0.00	0.00
	C	1	6.00	47.53	4.68	1.38	86.06	97.55	407.23	40.53	5.61
		2	6.00	27.73	0.08	0.00	1.09	66.56	6.65	0.00	0.08
	Cx	1	16.80	0.00	0.00	0.00	0.00	0.00	0.00	0.00	0.00
	D	1	6.00	66.01	0.49	0.10	8.33	104.41	30.58	2.83	0.42
Dx	1	16.45	0.00	0.00	0.00	0.00	0.00	0.00	0.00	0.00	

Traffic Stream Results: Queues and blocking

Time Segment	Arm	Traffic Stream	Initial queue (Veh)	Mean max queue (Veh)	Max queue storage (Veh)	Utilised storage (%)	Average storage excess queue (Veh)	Average limit excess queue (Veh)	Excess queue penalty (£ per hr)	Wasted time starvation (s (per cycle))	Wasted time blocking back (s (per cycle))	Wasted time total (s (per cycle))	Estimated blocking	
08:00-09:00	A	1	0.00	16.20	8.70	186.25	1.71	0.00	0.00	0.00	0.00	0.00		
	Ax	1	0.00	0.00	23.92	0.00	0.00	0.00	0.00	49.00	0.00	49.00		
	B	1	0.00	0.89	8.70	10.22	0.00	0.00	0.00	4.00	0.00	4.00		
	Bx	1	0.00	0.00	24.05	0.00	0.00	0.00	0.00	79.00	0.00	79.00		
	C	1	0.00	15.15	8.70	174.24	1.39	0.00	0.00	0.00	0.00	0.00	0.00	
		2	0.00	0.23	8.70	2.59	0.00	0.00	0.00	0.00	38.00	0.00	38.00	
	Cx	1	0.00	0.00	24.35	0.00	0.00	0.00	0.00	54.00	0.00	54.00		
	D	1	0.00	1.13	8.70	12.97	0.00	0.00	0.00	0.00	3.00	0.00	3.00	
Dx	1	0.00	0.00	23.84	0.00	0.00	0.00	0.00	0.00	120.00	0.00	120.00		

Pedestrian Crossing Results

Pedestrian Crossings: Pedestrian summary

Time Segment	Crossing	Side	Degree of saturation (%)	Calculated Flow Entering (Ped/hr)	Calculated sat flow (Ped/hr)	Actual green (s (per cycle))	Mean Delay Per Ped (s)	Mean max queue (Ped)	Weighted cost of delay (£ per hr)	Performance Index (£ per hr)
08:00-09:00	(ALL)	(ALL)	7	30	11000	5	55.58	0.96	6.58	6.58

Pedestrian Crossings: Flows and signals

Time Segment	Crossing	Side	Calculated flow entering (Ped/hr)	Calculated flow out (Ped/hr)	Flow discrepancy (Ped/hr)	Adjusted flow warning	Calculated sat flow (Ped/hr)	Calculated capacity (Ped/hr)	Degree of saturation (%)	DOS Threshold exceeded	Practical reserve capacity (%)	Mean modulus of error	Actual green (s (per cycle))
08:00-09:00	(ALL)	(ALL)	30	30	0		11000	458	7		1428	0.00	5

Pedestrian Crossings: Stops and delays

Time Segment	Crossing	Side	Mean Cruise Time per Ped (s)	Mean Delay per Ped (s)	Uniform delay (Ped-hr/hr)	Random plus oversat delay (Ped-hr/hr)	Weighted cost of delay (£ per hr)
08:00-09:00	1	1	5.67	55.58	0.46	0.00	6.58
		2	5.67	55.58	0.46	0.00	6.58
	2	1	6.33	55.58	0.46	0.00	6.58
		2	6.33	55.58	0.46	0.00	6.58
	3	1	6.33	55.58	0.46	0.00	6.58
		2	6.33	55.58	0.46	0.00	6.58
	4	1	5.67	55.58	0.46	0.00	6.58
		2	5.67	55.58	0.46	0.00	6.58

Pedestrian Crossings: Queues and blocking

Time Segment	Crossing	Side	Mean max queue (Ped)	Max queue storage (Ped)	Utilised storage (%)	Average storage excess queue (Ped)	Average limit excess queue (Ped)	Excess queue penalty (£ per hr)
08:00-09:00	(ALL)	(ALL)	0.96	10.00	9.58	0.00	0.00	0.00

Network Results

Network Results: Flows and signals

Time Segment	Calculated flow entering (Veh/hr)	Calculated flow out (Veh/hr)	Flow discrepancy (Veh/hr)	Adjusted flow warning	Degree of saturation (%)	DOS Threshold exceeded	Practical reserve capacity (%)	Actual green (s (per cycle))
08:00-09:00	2302	2302	0		78		27	648

Network Results: Stops and delays

Time Segment	Mean Cruise Time per Veh (s)	Mean Delay per Veh (s)	Uniform delay (Veh-hr/hr)	Random plus oversat delay (Veh-hr/hr)	Weighted cost of delay (£ per hr)	Mean stops per Veh (%)	Uniform stops (Stops per hr)	Random stops (Stops per hr)	Weighted cost of stops (£ per hr)
08:00-09:00	10.77	26.65	14.15	2.89	242.03	43.13	907.97	84.93	12.45

Network Results: Queues and blocking

Time Segment	Utilised storage (%)	Excess queue penalty (£ per hr)	Wasted time starvation (s per cycle))	Wasted time blocking back (s per cycle))	Wasted time total (s per cycle))
08:00-09:00	186.25	0.00	347.00	0.00	347.00

Final Prediction Table

Traffic Stream Results

Arm	Traffic Stream	Name	Traffic node	SIGNALS		FLOWS		PERFORMANCE				PER PCU			QUEUES
				Controller stream	Phase	Calculated flow entering (Veh/hr)	Calculated sat flow (Veh/hr)	Actual green (s per cycle))	Wasted time total (s per cycle))	Degree of saturation (%)	Practical reserve capacity (%)	JourneyTime (s)	Mean Delay per Veh (s)	Mean stops per Veh (%)	Mean max queue (Veh)
A	1	(untitled)	1	1	B	504 <	1800	42	0.00	78	28	49.99	43.99	94.98	16.20 +
Ax	1	(untitled)				491	Unrestricted	120	49.00	0	Unrestricted	16.50	0.00	0.00	0.00
B	1	(untitled)	1	1	C	26	1800	5	4.00	29	246	69.04	63.04	101.44	0.89
Bx	1	(untitled)				48	Unrestricted	120	79.00	0	Unrestricted	16.59	0.00	0.00	0.00
C	1	(untitled)	1	1	A	459 <	1800	38	0.00	78	27	53.53	47.53	97.55	15.15 +
	2	(untitled)	1	1	A	10	1800	38	38.00	2	5750	33.73	27.73	66.56	0.23
Cx	1	(untitled)				476	Unrestricted	120	54.00	0	Unrestricted	16.80	0.00	0.00	0.00
D	1	(untitled)	1	1	D	32	1800	5	3.00	36	181	72.01	66.01	104.41	1.13
Dx	1	(untitled)				16	Unrestricted	120	120.00	0	Unrestricted	16.45	0.00	0.00	0.00

Pedestrian Crossing Results

Pedestrian	Side	Name	Traffic node	SIGNALS		FLOWS		PERFORMANCE			PER PED		QUEUES	WEIGHTS	PEN
				Controller stream	Phase	Calculated Flow Entering (Ped/hr)	Calculated sat flow (Ped/hr)	Actual green (s per cycle))	Degree of saturation (%)	Practical reserve capacity (%)	JourneyTime (s)	Mean Delay per Ped (s)	Mean max queue (Ped)	Delay weighting (%)	Co tra pen (£ p
1	1	(untitled)	1	1	E	30	11000	5	7	1428	61.25	55.58	0.96	100	0
	2	(untitled)	1	1	E	30	11000	5	7	1428	61.25	55.58	0.96	100	0
2	1	(untitled)	1	1	E	30	11000	5	7	1428	61.92	55.58	0.96	100	0
	2	(untitled)	1	1	E	30	11000	5	7	1428	61.92	55.58	0.96	100	0
3	1	(untitled)	1	1	E	30	11000	5	7	1428	61.92	55.58	0.96	100	0
	2	(untitled)	1	1	E	30	11000	5	7	1428	61.92	55.58	0.96	100	0
4	1	(untitled)	1	1	E	30	11000	5	7	1428	61.25	55.58	0.96	100	0
	2	(untitled)	1	1	E	30	11000	5	7	1428	61.25	55.58	0.96	100	0

Network Results

	Distance travelled (PCU-km/hr)	Time spent (PCU-hr/hr)	Mean journey speed (kph)	Uniform delay (Veh-hr/hr)	Random plus oversat delay (Veh-hr/hr)	Weighted cost of delay (£ per hr)	Weighted cost of stops (£ per hr)	Excess queue penalty (£ per hr)	Performance Index (£ per hr)
Normal traffic	194.55	19.82	9.81	10.45	2.89	189.41	12.45	0.00	201.86
Bus	0.00	0.00	0.00	0.00	0.00	0.00	0.00	0.00	0.00
Tram	0.00	0.00	0.00	0.00	0.00	0.00	0.00	0.00	0.00
Pedestrians	2.04	4.11	0.50	3.71	0.00	52.62	0.00	0.00	52.62
TOTAL	196.59	23.93	8.22	14.15	2.89	242.03	12.45	0.00	254.48

- | < = adjusted flow warning (upstream links/traffic streams are over-saturated)
- | * = Traffic Stream - Normal, Bus or Tram Stop or Delay weighting has been set to a value other than 100%
- | ^ = Traffic Stream - Normal, Bus or Tram Stop or Delay Path weighting has been set to a value other than 100%
- | + = average link/traffic stream excess queue is greater than 0
- | **P.I. = PERFORMANCE INDEX**

A4 - DO SOMETHING 2024 D4 - DO SOMETHING 2024*

Summary

Data Errors and Warnings

No errors or warnings

Run Summary

Analysis set used	Run start time	Run finish time	Modelling start time (HH:mm)	Network Cycle Time (s)	Performance Index (£ per hr)	Total network delay (Veh-hr/hr)	Highest DOS (%)	Item with highest DOS	Number of oversaturated items	Percentage of oversaturated items (%)	Item with worst signalised PRC	Item with worst unsignalised PRC	Item with worst over PR
4	19/08/2020 12:11:22	19/08/2020 12:11:22	08:00	120	220.54	14.79	72.82	C/1	0	0	C/1	Dx/1	C/

Analysis Set Details

Name	Description	Demand set	Include in report	Locked
DO SOMETHING 2024	AM	D4	✓	

Demand Set Details

Name	Description	Composite	Demand sets	Start time (HH:mm)	Locked
DO SOMETHING 2024	AM			08:00	

Arms and Traffic Streams

Arms

Arm	Name	Description	Traffic node
A	(untitled)		1
Ax	(untitled)		
B	(untitled)		1
Bx	(untitled)		
C	(untitled)		1
Cx	(untitled)		
D	(untitled)		1
Dx	(untitled)		

Traffic Streams

Arm	Traffic Stream	Name	Description	Auto length	Length (m)	Has Saturation Flow	Saturation flow source	Saturation flow (PCU/hr)	Is signal controlled	Is give way	Traffic type	Allow Nearside Turn On Red
A	1	(untitled)		✓	50.00	✓	Sum of lanes	1800	✓		Normal	
Ax	1	(untitled)		✓	137.53						Normal	
B	1	(untitled)		✓	50.00	✓	Sum of lanes	1800	✓		Normal	
Bx	1	(untitled)		✓	138.27						Normal	
C	1	(untitled)		✓	50.00	✓	Sum of lanes	1800	✓		Normal	
	2	(untitled)		✓	50.00	✓	Sum of lanes	1800	✓		Normal	
Cx	1	(untitled)		✓	140.00						Normal	
D	1	(untitled)		✓	50.00	✓	Sum of lanes	1800	✓		Normal	
Dx	1	(untitled)		✓	137.05						Normal	

Lanes

Arm	Traffic Stream	Lane	Name	Description	Use RR67	Saturation flow (PCU/hr)
A	1	1	(untitled)			1800
Ax	1	1	(untitled)			
B	1	1	(untitled)			1800
Bx	1	1	(untitled)			
C	1	1	(untitled)			1800
	2	1	(untitled)			1800
Cx	1	1	(untitled)			
D	1	1	(untitled)			1800
Dx	1	1	(untitled)			

Modelling

Arm	Traffic Stream	Traffic model	Stop weighting multiplier (%)	Delay weighting multiplier (%)	Assignment Cost Weighting (%)	Exclude from results calculation	Max queue storage (PCU)	Has queue limit	Has degree of saturation limit
(ALL)	(ALL)	NetworkDefault	100	100	100		0.00		

Modelling - Advanced

Arm	Traffic Stream	Initial queue (PCU)	Type of Vehicle-in-Service	Vehicle-in-Service	Type of random parameter	Random parameter	Auto cycle time	Cycle time
(ALL)	(ALL)	0.00	NetworkDefault	Not-Included	NetworkDefault	0.50	✓	120

Normal traffic - Modelling

Arm	Traffic Stream	Stop weighting (%)	Delay weighting (%)
(ALL)	(ALL)	100	100

Normal traffic - Advanced

Arm	Traffic Stream	Dispersion type for Normal Traffic
(ALL)	(ALL)	NetworkDefault

Flows

Arm	Traffic Stream	Total Flow (Veh/hr)	Normal Flow (Veh/hr)
A	1	421	421
Ax	1	470	470
B	1	43	43
Bx	1	24	24
C	1	426	426
	2	6	6
Cx	1	418	418
D	1	32	32
Dx	1	16	16

Signals

Arm	Traffic Stream	Controller stream	Phase	Second phase enabled
A	1	1	B	
B	1	1	C	
C	1	1	A	
	2	1	A	
D	1	1	D	

Pedestrian Crossings

Pedestrian Crossings

Crossing	Name	Description	Traffic node	Allow walk on red	Crossing type	Length (m)	Cruise time (seconds)	Cruise speed (kph)
1	(untitled)		1		Farside	7.00	4.67	5.40
2	(untitled)		1		Farside	8.00	5.33	5.40
3	(untitled)		1		Farside	8.00	5.33	5.40
4	(untitled)		1		Farside	7.00	4.67	5.40

Pedestrian Crossings - Signals

Crossing	Controller stream	Phase	Second phase enabled
(ALL)	1	E	

Pedestrian Crossings - Sides

Crossing	Side	Saturation flow (Ped/hr)
(ALL)	(ALL)	11000

Pedestrian Crossings - Modelling

Crossing	Side	Delay weighting (%)	Assignment Cost Weighting (%)	Exclude from results calculation	Max queue storage (Ped)	Has queue limit	Has degree of saturation limit
(ALL)	(ALL)	100	100		0.00		

Local OD Matrix - Local Matrix: 1

Local Matrix Options

OD Matrix	Name	Use for point to point table	Auto calculate	Allocation mode	Allow paths past exit locations	Allow looped paths on arms	Allow looped paths on traffic nodes	Copy flows	Matrix to copy flows from	Limit paths by length	Path length limit multiplier	Limit paths by number	Path number limit
1	(untitled)	✓	✓	Path Equalisation	✓		✓			✓	1.25		

Normal Input Flows (Veh/hr)

		To							
		1	2	3	4	5	6	7	8
From	1	0	7	419	6	0	0	0	0
	2	14	0	18	0	0	0	0	0
	3	394	9	0	18	0	0	0	0
	4	10	0	33	0	0	0	0	0
	5	0	0	0	0	0	0	0	0
	6	0	0	0	0	0	0	0	0
	7	0	0	0	0	0	0	0	0
	8	0	0	0	0	0	0	0	0

Bus Input Flows not shown as they are blank.

Tram Input Flows not shown as they are blank.

Pedestrian Input Flows (Veh/hr)

From	To							
	1	2	3	4	5	6	7	8
1	0	0	0	0	0	0	0	0
2	0	0	0	0	0	0	0	0
3	0	0	0	0	0	0	0	0
4	0	0	0	0	0	0	0	0
5	0	0	0	0	0	30	30	0
6	0	0	0	0	30	0	0	30
7	0	0	0	0	30	0	0	30
8	0	0	0	0	0	30	30	0

Locations

OD Matrix	Location	Name	Entries	Exits	Colour
1	1	(untitled)	C/1, C/2	Cx/1	#0000FF
	2	(untitled)	D/1	Dx/1	#FF0000
	3	(untitled)	A/1	Ax/1	#00FF00
	4	(untitled)	B/1	Bx/1	#FFFF00
	5	(untitled)	3:2E, 1:1E	3:2X, 1:1X	#FF00FF
	6	(untitled)	2:1E, 1:2E	2:1X, 1:2X	#008000
	7	(untitled)	4:2E, 3:1E	4:2X, 3:1X	#FFA500
	8	(untitled)	4:1E, 2:2E	4:1X, 2:2X	#00FFFF

Normal Paths and Flows

OD Matrix	Path	Description	From location	To location	Path items	Allocation type	Normal Calculated Flow (Veh/hr)
1	1		1	2	C/1, Dx/1	Normal	7
	2		1	3	C/1, Ax/1	Normal	419
	5		2	3	D/1, Ax/1	Normal	18
	6		2	4	D/1, Bx/1	Normal	0
	7		2	1	D/1, Cx/1	Normal	14
	8		3	2	A/1, Dx/1	Normal	9
	9		3	4	A/1, Bx/1	Normal	18
	10		3	1	A/1, Cx/1	Normal	394
	11		4	2	B/1, Dx/1	Normal	0
	12		4	3	B/1, Ax/1	Normal	33
	13		4	1	B/1, Cx/1	Normal	10
	21		1	4	C/2, Bx/1	Normal	6

Pedestrian Paths and Flows

OD Matrix	Path	Description	From location	To location	Path items	Allocation type	Pedestrian calculated flow (Ped/hr)
1	17		8	7	4:1E, 4:2X	Normal	30
	18		8	6	2:2E, 2:1X	Normal	30
	22		5	7	3:2E, 3:1X	Normal	30
	23		5	6	1:1E, 1:2X	Normal	30
	34		6	8	2:1E, 2:2X	Normal	30
	35		6	5	1:2E, 1:1X	Normal	30
	41		7	8	4:2E, 4:1X	Normal	30
	42		7	5	3:1E, 3:2X	Normal	30

Signal Timings

Network Default: 120s cycle time; 120 steps

Controller Stream 1

Controller Stream	Name	Description	Use sequence	Cycle time source	Cycle time (s)
1	(untitled)		1	NetworkDefault	120

Controller Stream 1 - Properties

Controller Stream	Manufacturer name	Type	Model number	(Telephone) Line Number	Site number	Grid reference	Gaining delay type
1	Unspecified						Relative

Controller Stream 1 - Optimisation

Controller Stream	Allow offset optimisation	Allow green split optimisation	Optimisation level	Auto redistribute	Enable stage constraint
1	✓	✓	Offsets And Green Splits	✓	

Phases

Controller Stream	Phase	Name	Minimum green (s)	Maximum green (s)	Relative start displacement (s)	Relative end displacement (s)	Type	Blackout Time (s)
1	A	(untitled)	38	300	0	0	Traffic	
	B	(untitled)	5	300	0	0	Traffic	
	C	(untitled)	5	300	0	0	Traffic	
	D	(untitled)	5	300	0	0	Traffic	
	E	(untitled)	5	300	0	0	Pedestrian	0

Library Stages

Controller Stream	Library Stage	Phases in stage	User stage minimum (s)
1	1	A	1
	2	B	1
	3	C	1
	4	D	1
	5	E	1

Stage Sequences

Controller Stream	Sequence	Name	Multiple cycling	Stage IDs	Stage ends
1	1	(untitled)	Single	1, 2, 3, 4, 5	32, 79, 89, 99, 109

Intergreen Matrix for Controller Stream 1

		To				
		A	B	C	D	E
From	A		5	5	5	5
	B	5		5	5	5
	C	5	5		5	5
	D	5	5	5		5
	E	5	5	5	5	

Banned Stage transitions for Controller Stream 1

		To				
		1	2	3	4	5
From	1					
	2					
	3					
	4					
	5					

Interstage Matrix for Controller Stream 1

		To				
		1	2	3	4	5
From	1	0	5	5	5	5
	2	5	0	5	5	5
	3	5	5	0	5	5
	4	5	5	5	0	5
	5	5	5	5	5	0

Resultant Stages

Controller Stream	Resultant Stage	Is base stage	Library Stage ID	Phases in this stage	Stage start (s)	Stage end (s)	Stage duration (s)	User stage minimum (s)	Stage minimum (s)
1	1	✓	1	A	114	32	38	1	38
	2	✓	2	B	37	79	42	1	5
	3	✓	3	C	84	89	5	1	5
	4	✓	4	D	94	99	5	1	5
	5	✓	5	E	104	109	5	1	5

Resultant Phase Green Periods

Controller Stream	Phase	Green period	Is base green period	Start time (s)	End time (s)	Duration (s)
1	A	1	✓	114	32	38
	B	1	✓	37	79	42
	C	1	✓	84	89	5
	D	1	✓	94	99	5
	E	1	✓	104	109	5

Traffic Stream Green Times

Arm	Traffic Stream	Traffic Node	Controller Stream	Phase	Green Period 1		
					Start	End	Duration
A	1	1	1	B	37	79	42
B	1	1	1	C	84	89	5
C	1	1	1	A	114	32	38
C	2	1	1	A	114	32	38
D	1	1	1	D	94	99	5

Phase Timings Diagram for Controller Stream 1

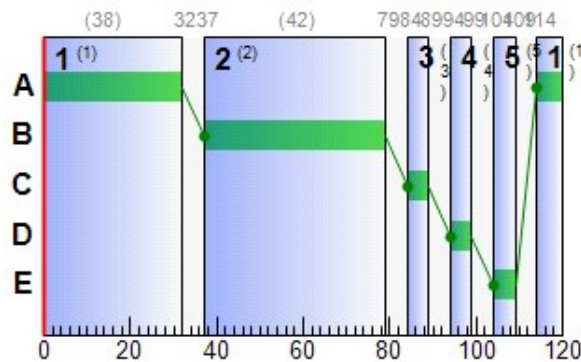

Stage Sequence Diagram for Controller Stream 1

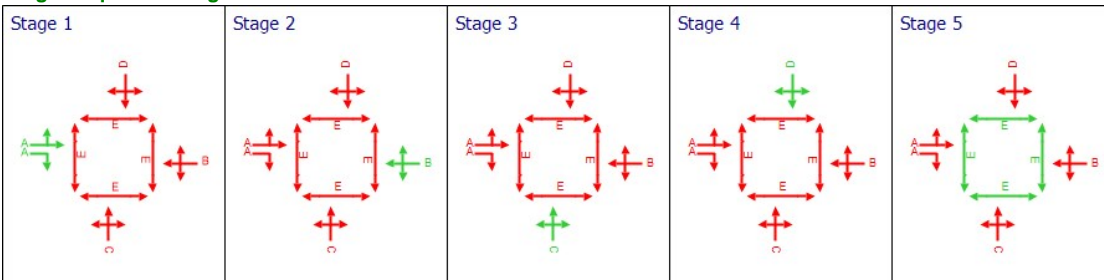

Resultant penalties

Time Segment	Controller stream	Phase min max penalty (£ per hr)	Intergreen broken penalty (£ per hr)	Stage constraint broken penalty (£ per hr)	Cost of controller stream penalties (£ per hr)
08:00-09:00	1	0.00	0.00	0.00	0.00

Traffic Stream Results

Traffic Stream Results: Vehicle summary

Time Segment	Arm	Traffic Stream	Degree of saturation (%)	Practical reserve capacity (%)	Calculated flow entering (Veh/hr)	Calculated sat flow (Veh/hr)	Actual green (s (per cycle))	Mean Delay per Veh (s)	Mean max queue (Veh)	Utilised storage (%)	Weighted cost of delay (£ per hr)	Weighted cost of stops (£ per hr)	Performance Index (£ per hr)
08:00-09:00	A	1	65	53	421	1800	42	37.44	12.30	141.46	62.17	4.55	66.72
	Ax	1	0	Unrestricted	470	Unrestricted	120	0.00	0.00	0.00	0.00	0.00	0.00
	B	1	48	109	43	1800	5	73.28	1.60	18.38	12.43	0.59	13.02
	Bx	1	0	Unrestricted	24	Unrestricted	120	0.00	0.00	0.00	0.00	0.00	0.00
	C	1	73	37	426	1800	38	43.89	13.50	155.23	73.75	4.98	78.72
		2	1	9650	6	1800	38	27.71	0.14	1.55	0.66	0.05	0.71
	Cx	1	0	Unrestricted	418	Unrestricted	120	0.00	0.00	0.00	0.00	0.00	0.00
	D	1	36	181	32	1800	5	66.01	1.13	12.97	8.33	0.42	8.75
Dx	1	0	Unrestricted	16	Unrestricted	120	0.00	0.00	0.00	0.00	0.00	0.00	

Traffic Stream Results: Flows and signals

Time Segment	Arm	Traffic Stream	Calculated flow entering (Veh/hr)	Calculated flow out (Veh/hr)	Flow discrepancy (Veh/hr)	Adjusted flow warning	Calculated sat flow (Veh/hr)	Calculated capacity (Veh/hr)	Degree of saturation (%)	DOS Threshold exceeded	Practical reserve capacity (%)	Mean modulus of error	Actual green (s (per cycle))
08:00-09:00	A	1	421	421	0		1800	645	65		53	0.00	42
	Ax	1	470	470	0		Unrestricted	Unrestricted	0		Unrestricted	1.06	120
	B	1	43	43	0		1800	90	48		109	0.00	5
	Bx	1	24	24	0		Unrestricted	Unrestricted	0		Unrestricted	0.90	120
	C	1	426	426	0		1800	585	73		37	0.00	38
		2	6	6	0		1800	585	1		9650	0.00	38
	Cx	1	418	418	0		Unrestricted	Unrestricted	0		Unrestricted	1.09	120
	D	1	32	32	0		1800	90	36		181	0.00	5
Dx	1	16	16	0		Unrestricted	Unrestricted	0		Unrestricted	0.70	120	

Traffic Stream Results: Stops and delays

Time Segment	Arm	Traffic Stream	Mean Cruise Time per Veh (s)	Mean Delay per Veh (s)	Uniform delay (Veh-hr/hr)	Random plus oversat delay (Veh-hr/hr)	Weighted cost of delay (£ per hr)	Mean stops per Veh (%)	Uniform stops (Stops per hr)	Random stops (Stops per hr)	Weighted cost of stops (£ per hr)
08:00-09:00	A	1	6.00	37.44	3.77	0.61	62.17	86.27	345.20	18.00	4.55
	Ax	1	16.50	0.00	0.00	0.00	0.00	0.00	0.00	0.00	0.00
	B	1	6.00	73.28	0.66	0.21	12.43	109.96	41.14	6.14	0.59
	Bx	1	16.59	0.00	0.00	0.00	0.00	0.00	0.00	0.00	0.00
	C	1	6.00	43.89	4.24	0.96	73.75	93.16	368.66	28.18	4.98
		2	6.00	27.71	0.05	0.00	0.66	66.54	3.99	0.00	0.05
	Cx	1	16.80	0.00	0.00	0.00	0.00	0.00	0.00	0.00	0.00
	D	1	6.00	66.01	0.49	0.10	8.33	104.41	30.58	2.83	0.42
Dx	1	16.45	0.00	0.00	0.00	0.00	0.00	0.00	0.00	0.00	

Traffic Stream Results: Queues and blocking

Time Segment	Arm	Traffic Stream	Initial queue (Veh)	Mean max queue (Veh)	Max queue storage (Veh)	Utilised storage (%)	Average storage excess queue (Veh)	Average limit excess queue (Veh)	Excess queue penalty (£ per hr)	Wasted time starvation (s (per cycle))	Wasted time blocking back (s (per cycle))	Wasted time total (s (per cycle))	Estimated blocking	
08:00-09:00	A	1	0.00	12.30	8.70	141.46	0.48	0.00	0.00	0.00	0.00	0.00		
	Ax	1	0.00	0.00	23.92	0.00	0.00	0.00	0.00	49.00	0.00	49.00		
	B	1	0.00	1.60	8.70	18.38	0.00	0.00	0.00	3.00	0.00	3.00		
	Bx	1	0.00	0.00	24.05	0.00	0.00	0.00	0.00	99.00	0.00	99.00		
	C	1	0.00	13.50	8.70	155.23	0.83	0.00	0.00	0.00	0.00	0.00	0.00	
		2	0.00	0.14	8.70	1.55	0.00	0.00	0.00	0.00	38.00	0.00	38.00	
	Cx	1	0.00	0.00	24.35	0.00	0.00	0.00	0.00	53.00	0.00	53.00		
	D	1	0.00	1.13	8.70	12.97	0.00	0.00	0.00	0.00	3.00	0.00	3.00	
	Dx	1	0.00	0.00	23.84	0.00	0.00	0.00	0.00	120.00	0.00	120.00		

Pedestrian Crossing Results

Pedestrian Crossings: Pedestrian summary

Time Segment	Crossing	Side	Degree of saturation (%)	Calculated Flow Entering (Ped/hr)	Calculated sat flow (Ped/hr)	Actual green (s (per cycle))	Mean Delay Per Ped (s)	Mean max queue (Ped)	Weighted cost of delay (£ per hr)	Performance Index (£ per hr)
08:00-09:00	(ALL)	(ALL)	7	30	11000	5	55.58	0.96	6.58	6.58

Pedestrian Crossings: Flows and signals

Time Segment	Crossing	Side	Calculated flow entering (Ped/hr)	Calculated flow out (Ped/hr)	Flow discrepancy (Ped/hr)	Adjusted flow warning	Calculated sat flow (Ped/hr)	Calculated capacity (Ped/hr)	Degree of saturation (%)	DOS Threshold exceeded	Practical reserve capacity (%)	Mean modulus of error	Actual green (s (per cycle))
08:00-09:00	(ALL)	(ALL)	30	30	0		11000	458	7		1428	0.00	5

Pedestrian Crossings: Stops and delays

Time Segment	Crossing	Side	Mean Cruise Time per Ped (s)	Mean Delay per Ped (s)	Uniform delay (Ped-hr/hr)	Random plus oversat delay (Ped-hr/hr)	Weighted cost of delay (£ per hr)
08:00-09:00	1	1	5.67	55.58	0.46	0.00	6.58
		2	5.67	55.58	0.46	0.00	6.58
	2	1	6.33	55.58	0.46	0.00	6.58
		2	6.33	55.58	0.46	0.00	6.58
	3	1	6.33	55.58	0.46	0.00	6.58
		2	6.33	55.58	0.46	0.00	6.58
	4	1	5.67	55.58	0.46	0.00	6.58
		2	5.67	55.58	0.46	0.00	6.58

Pedestrian Crossings: Queues and blocking

Time Segment	Crossing	Side	Mean max queue (Ped)	Max queue storage (Ped)	Utilised storage (%)	Average storage excess queue (Ped)	Average limit excess queue (Ped)	Excess queue penalty (£ per hr)
08:00-09:00	(ALL)	(ALL)	0.96	10.00	9.58	0.00	0.00	0.00

Network Results

Network Results: Flows and signals

Time Segment	Calculated flow entering (Veh/hr)	Calculated flow out (Veh/hr)	Flow discrepancy (Veh/hr)	Adjusted flow warning	Degree of saturation (%)	DOS Threshold exceeded	Practical reserve capacity (%)	Actual green (s (per cycle))
08:00-09:00	2096	2096	0		73		37	648

Network Results: Stops and delays

Time Segment	Mean Cruise Time per Veh (s)	Mean Delay per Veh (s)	Uniform delay (Veh-hr/hr)	Random plus oversat delay (Veh-hr/hr)	Weighted cost of delay (£ per hr)	Mean stops per Veh (%)	Uniform stops (Stops per hr)	Random stops (Stops per hr)	Weighted cost of stops (£ per hr)
08:00-09:00	10.71	25.39	12.91	1.87	209.95	40.30	789.57	55.16	10.59

Network Results: Queues and blocking

Time Segment	Utilised storage (%)	Excess queue penalty (£ per hr)	Wasted time starvation (s per cycle))	Wasted time blocking back (s per cycle))	Wasted time total (s per cycle))
08:00-09:00	155.23	0.00	365.00	0.00	365.00

Final Prediction Table

Traffic Stream Results

Arm	Traffic Stream	Name	Traffic node	SIGNALS		FLOWS		PERFORMANCE				PER PCU			QUEUES
				Controller stream	Phase	Calculated flow entering (Veh/hr)	Calculated sat flow (Veh/hr)	Actual green (s per cycle))	Wasted time total (s per cycle))	Degree of saturation (%)	Practical reserve capacity (%)	JourneyTime (s)	Mean Delay per Veh (s)	Mean stops per Veh (%)	Mean max queue (Veh)
A	1	(untitled)	1	1	B	421 <	1800	42	0.00	65	53	43.44	37.44	86.27	12.30 +
Ax	1	(untitled)				470	Unrestricted	120	49.00	0	Unrestricted	16.50	0.00	0.00	0.00
B	1	(untitled)	1	1	C	43	1800	5	3.00	48	109	79.28	73.28	109.96	1.60
Bx	1	(untitled)				24	Unrestricted	120	99.00	0	Unrestricted	16.59	0.00	0.00	0.00
C	1	(untitled)	1	1	A	426 <	1800	38	0.00	73	37	49.89	43.89	93.16	13.50 +
	2	(untitled)	1	1	A	6	1800	38	38.00	1	9650	33.71	27.71	66.54	0.14
Cx	1	(untitled)				418	Unrestricted	120	53.00	0	Unrestricted	16.80	0.00	0.00	0.00
D	1	(untitled)	1	1	D	32	1800	5	3.00	36	181	72.01	66.01	104.41	1.13
Dx	1	(untitled)				16	Unrestricted	120	120.00	0	Unrestricted	16.45	0.00	0.00	0.00

Pedestrian Crossing Results

Pedestrian	Side	Name	Traffic node	SIGNALS		FLOWS		PERFORMANCE			PER PED		QUEUES	WEIGHTS	PEN
				Controller stream	Phase	Calculated Flow Entering (Ped/hr)	Calculated sat flow (Ped/hr)	Actual green (s per cycle))	Degree of saturation (%)	Practical reserve capacity (%)	JourneyTime (s)	Mean Delay per Ped (s)	Mean max queue (Ped)	Delay weighting (%)	Co tra pen (£ p
1	1	(untitled)	1	1	E	30	11000	5	7	1428	61.25	55.58	0.96	100	0
	2	(untitled)	1	1	E	30	11000	5	7	1428	61.25	55.58	0.96	100	0
2	1	(untitled)	1	1	E	30	11000	5	7	1428	61.92	55.58	0.96	100	0
	2	(untitled)	1	1	E	30	11000	5	7	1428	61.92	55.58	0.96	100	0
3	1	(untitled)	1	1	E	30	11000	5	7	1428	61.92	55.58	0.96	100	0
	2	(untitled)	1	1	E	30	11000	5	7	1428	61.92	55.58	0.96	100	0
4	1	(untitled)	1	1	E	30	11000	5	7	1428	61.25	55.58	0.96	100	0
	2	(untitled)	1	1	E	30	11000	5	7	1428	61.25	55.58	0.96	100	0

Network Results

	Distance travelled (PCU-km/hr)	Time spent (PCU-hr/hr)	Mean journey speed (kph)	Uniform delay (Veh-hr/hr)	Random plus oversat delay (Veh-hr/hr)	Weighted cost of delay (£ per hr)	Weighted cost of stops (£ per hr)	Excess queue penalty (£ per hr)	Performance Index (£ per hr)
Normal traffic	175.07	16.92	10.35	9.21	1.87	157.33	10.59	0.00	167.92
Bus	0.00	0.00	0.00	0.00	0.00	0.00	0.00	0.00	0.00
Tram	0.00	0.00	0.00	0.00	0.00	0.00	0.00	0.00	0.00
Pedestrians	2.04	4.11	0.50	3.71	0.00	52.62	0.00	0.00	52.62
TOTAL	177.11	21.02	8.43	12.91	1.87	209.95	10.59	0.00	220.54

- | < = adjusted flow warning (upstream links/traffic streams are over-saturated)
- | * = Traffic Stream - Normal, Bus or Tram Stop or Delay weighting has been set to a value other than 100%
- | ^ = Traffic Stream - Normal, Bus or Tram Stop or Delay Path weighting has been set to a value other than 100%
- | + = average link/traffic stream excess queue is greater than 0
- | **P.I. = PERFORMANCE INDEX**

A5 - DO SOMETHING 2029 D5 - DO SOMETHING 2029*

Summary

Data Errors and Warnings

No errors or warnings

Run Summary

Analysis set used	Run start time	Run finish time	Modelling start time (HH:mm)	Network Cycle Time (s)	Performance Index (£ per hr)	Total network delay (Veh-hr/hr)	Highest DOS (%)	Item with highest DOS	Number of oversaturated items	Percentage of oversaturated items (%)	Item with worst signalised PRC	Item with worst unsignalised PRC	Item with worst over PR
5	19/08/2020 12:11:23	19/08/2020 12:11:23	08:00	120	272.80	18.28	79.66	C/1	0	0	C/1	Dx/1	C/

Analysis Set Details

Name	Description	Demand set	Include in report	Locked
DO SOMETHING 2029	AM	D5	✓	

Demand Set Details

Name	Description	Composite	Demand sets	Start time (HH:mm)	Locked
DO SOMETHING 2029	AM			08:00	

Arms and Traffic Streams

Arms

Arm	Name	Description	Traffic node
A	(untitled)		1
Ax	(untitled)		
B	(untitled)		1
Bx	(untitled)		
C	(untitled)		1
Cx	(untitled)		
D	(untitled)		1
Dx	(untitled)		

Traffic Streams

Arm	Traffic Stream	Name	Description	Auto length	Length (m)	Has Saturation Flow	Saturation flow source	Saturation flow (PCU/hr)	Is signal controlled	Is give way	Traffic type	Allow Nearside Turn On Red
A	1	(untitled)		✓	50.00	✓	Sum of lanes	1800	✓		Normal	
Ax	1	(untitled)		✓	137.53						Normal	
B	1	(untitled)		✓	50.00	✓	Sum of lanes	1800	✓		Normal	
Bx	1	(untitled)		✓	138.27						Normal	
C	1	(untitled)		✓	50.00	✓	Sum of lanes	1800	✓		Normal	
	2	(untitled)		✓	50.00	✓	Sum of lanes	1800	✓		Normal	
Cx	1	(untitled)		✓	140.00						Normal	
D	1	(untitled)		✓	50.00	✓	Sum of lanes	1800	✓		Normal	
Dx	1	(untitled)		✓	137.05						Normal	

Lanes

Arm	Traffic Stream	Lane	Name	Description	Use RR67	Saturation flow (PCU/hr)
A	1	1	(untitled)			1800
Ax	1	1	(untitled)			
B	1	1	(untitled)			1800
Bx	1	1	(untitled)			
C	1	1	(untitled)			1800
	2	1	(untitled)			1800
Cx	1	1	(untitled)			
D	1	1	(untitled)			1800
Dx	1	1	(untitled)			

Modelling

Arm	Traffic Stream	Traffic model	Stop weighting multiplier (%)	Delay weighting multiplier (%)	Assignment Cost Weighting (%)	Exclude from results calculation	Max queue storage (PCU)	Has queue limit	Has degree of saturation limit
(ALL)	(ALL)	NetworkDefault	100	100	100		0.00		

Modelling - Advanced

Arm	Traffic Stream	Initial queue (PCU)	Type of Vehicle-in-Service	Vehicle-in-Service	Type of random parameter	Random parameter	Auto cycle time	Cycle time
(ALL)	(ALL)	0.00	NetworkDefault	Not-Included	NetworkDefault	0.50	✓	120

Normal traffic - Modelling

Arm	Traffic Stream	Stop weighting (%)	Delay weighting (%)
(ALL)	(ALL)	100	100

Normal traffic - Advanced

Arm	Traffic Stream	Dispersion type for Normal Traffic
(ALL)	(ALL)	NetworkDefault

Flows

Arm	Traffic Stream	Total Flow (Veh/hr)	Normal Flow (Veh/hr)
A	1	504	504
Ax	1	522	522
B	1	58	58
Bx	1	65	65
C	1	466	466
	2	14	14
Cx	1	471	471
D	1	32	32
Dx	1	16	16

Signals

Arm	Traffic Stream	Controller stream	Phase	Second phase enabled
A	1	1	B	
B	1	1	C	
C	1	1	A	
	2	1	A	
D	1	1	D	

Pedestrian Crossings

Pedestrian Crossings

Crossing	Name	Description	Traffic node	Allow walk on red	Crossing type	Length (m)	Cruise time (seconds)	Cruise speed (kph)
1	(untitled)		1		Farside	7.00	4.67	5.40
2	(untitled)		1		Farside	8.00	5.33	5.40
3	(untitled)		1		Farside	8.00	5.33	5.40
4	(untitled)		1		Farside	7.00	4.67	5.40

Pedestrian Crossings - Signals

Crossing	Controller stream	Phase	Second phase enabled
(ALL)	1	E	

Pedestrian Crossings - Sides

Crossing	Side	Saturation flow (Ped/hr)
(ALL)	(ALL)	11000

Pedestrian Crossings - Modelling

Crossing	Side	Delay weighting (%)	Assignment Cost Weighting (%)	Exclude from results calculation	Max queue storage (Ped)	Has queue limit	Has degree of saturation limit
(ALL)	(ALL)	100	100		0.00		

Local OD Matrix - Local Matrix: 1

Local Matrix Options

OD Matrix	Name	Use for point to point table	Auto calculate	Allocation mode	Allow paths past exit locations	Allow looped paths on arms	Allow looped paths on traffic nodes	Copy flows	Matrix to copy flows from	Limit paths by length	Path length limit multiplier	Limit paths by number	Path number limit
1	(untitled)	✓	✓	Path Equalisation	✓		✓			✓	1.25		

Normal Input Flows (Veh/hr)

		To							
		1	2	3	4	5	6	7	8
From	1	0	7	459	14	0	0	0	0
	2	14	0	18	0	0	0	0	0
	3	444	9	0	51	0	0	0	0
	4	13	0	45	0	0	0	0	0
	5	0	0	0	0	0	0	0	0
	6	0	0	0	0	0	0	0	0
	7	0	0	0	0	0	0	0	0
	8	0	0	0	0	0	0	0	0

Bus Input Flows not shown as they are blank.

Tram Input Flows not shown as they are blank.

Pedestrian Input Flows (Veh/hr)

From	To							
	1	2	3	4	5	6	7	8
1	0	0	0	0	0	0	0	0
2	0	0	0	0	0	0	0	0
3	0	0	0	0	0	0	0	0
4	0	0	0	0	0	0	0	0
5	0	0	0	0	0	30	30	0
6	0	0	0	0	30	0	0	30
7	0	0	0	0	30	0	0	30
8	0	0	0	0	0	30	30	0

Locations

OD Matrix	Location	Name	Entries	Exits	Colour
1	1	(untitled)	C/1, C/2	Cx/1	#0000FF
	2	(untitled)	D/1	Dx/1	#FF0000
	3	(untitled)	A/1	Ax/1	#00FF00
	4	(untitled)	B/1	Bx/1	#FFFF00
	5	(untitled)	3:2E, 1:1E	3:2X, 1:1X	#FF00FF
	6	(untitled)	2:1E, 1:2E	2:1X, 1:2X	#008000
	7	(untitled)	4:2E, 3:1E	4:2X, 3:1X	#FFA500
	8	(untitled)	4:1E, 2:2E	4:1X, 2:2X	#00FFFF

Normal Paths and Flows

OD Matrix	Path	Description	From location	To location	Path items	Allocation type	Normal Calculated Flow (Veh/hr)
1	1		1	2	C/1, Dx/1	Normal	7
	2		1	3	C/1, Ax/1	Normal	459
	5		2	3	D/1, Ax/1	Normal	18
	6		2	4	D/1, Bx/1	Normal	0
	7		2	1	D/1, Cx/1	Normal	14
	8		3	2	A/1, Dx/1	Normal	9
	9		3	4	A/1, Bx/1	Normal	51
	10		3	1	A/1, Cx/1	Normal	444
	11		4	2	B/1, Dx/1	Normal	0
	12		4	3	B/1, Ax/1	Normal	45
	13		4	1	B/1, Cx/1	Normal	13
	21		1	4	C/2, Bx/1	Normal	14

Pedestrian Paths and Flows

OD Matrix	Path	Description	From location	To location	Path items	Allocation type	Pedestrian calculated flow (Ped/hr)
1	17		8	7	4:1E, 4:2X	Normal	30
	18		8	6	2:2E, 2:1X	Normal	30
	22		5	7	3:2E, 3:1X	Normal	30
	23		5	6	1:1E, 1:2X	Normal	30
	34		6	8	2:1E, 2:2X	Normal	30
	35		6	5	1:2E, 1:1X	Normal	30
	41		7	8	4:2E, 4:1X	Normal	30
	42		7	5	3:1E, 3:2X	Normal	30

Signal Timings

Network Default: 120s cycle time; 120 steps

Controller Stream 1

Controller Stream	Name	Description	Use sequence	Cycle time source	Cycle time (s)
1	(untitled)		1	NetworkDefault	120

Controller Stream 1 - Properties

Controller Stream	Manufacturer name	Type	Model number	(Telephone) Line Number	Site number	Grid reference	Gaining delay type
1	Unspecified						Relative

Controller Stream 1 - Optimisation

Controller Stream	Allow offset optimisation	Allow green split optimisation	Optimisation level	Auto redistribute	Enable stage constraint
1	✓	✓	Offsets And Green Splits	✓	

Phases

Controller Stream	Phase	Name	Minimum green (s)	Maximum green (s)	Relative start displacement (s)	Relative end displacement (s)	Type	Blackout Time (s)
1	A	(untitled)	38	300	0	0	Traffic	
	B	(untitled)	5	300	0	0	Traffic	
	C	(untitled)	5	300	0	0	Traffic	
	D	(untitled)	5	300	0	0	Traffic	
	E	(untitled)	5	300	0	0	Pedestrian	0

Library Stages

Controller Stream	Library Stage	Phases in stage	User stage minimum (s)
1	1	A	1
	2	B	1
	3	C	1
	4	D	1
	5	E	1

Stage Sequences

Controller Stream	Sequence	Name	Multiple cycling	Stage IDs	Stage ends
1	1	(untitled)	Single	1, 2, 3, 4, 5	33, 80, 90, 100, 110

Intergreen Matrix for Controller Stream 1

		To				
		A	B	C	D	E
From	A		5	5	5	5
	B	5		5	5	5
	C	5	5		5	5
	D	5	5	5		5
	E	5	5	5	5	

Banned Stage transitions for Controller Stream 1

		To				
		1	2	3	4	5
From	1					
	2					
	3					
	4					
	5					

Interstage Matrix for Controller Stream 1

		To				
		1	2	3	4	5
From	1	0	5	5	5	5
	2	5	0	5	5	5
	3	5	5	0	5	5
	4	5	5	5	0	5
	5	5	5	5	5	0

Resultant Stages

Controller Stream	Resultant Stage	Is base stage	Library Stage ID	Phases in this stage	Stage start (s)	Stage end (s)	Stage duration (s)	User stage minimum (s)	Stage minimum (s)
1	1	✓	1	A	115	33	38	1	38
	2	✓	2	B	38	80	42	1	5
	3	✓	3	C	85	90	5	1	5
	4	✓	4	D	95	100	5	1	5
	5	✓	5	E	105	110	5	1	5

Resultant Phase Green Periods

Controller Stream	Phase	Green period	Is base green period	Start time (s)	End time (s)	Duration (s)
1	A	1	✓	115	33	38
	B	1	✓	38	80	42
	C	1	✓	85	90	5
	D	1	✓	95	100	5
	E	1	✓	105	110	5

Traffic Stream Green Times

Arm	Traffic Stream	Traffic Node	Controller Stream	Phase	Green Period 1		
					Start	End	Duration
A	1	1	1	B	38	80	42
B	1	1	1	C	85	90	5
C	1	1	1	A	115	33	38
C	2	1	1	A	115	33	38
D	1	1	1	D	95	100	5

Phase Timings Diagram for Controller Stream 1

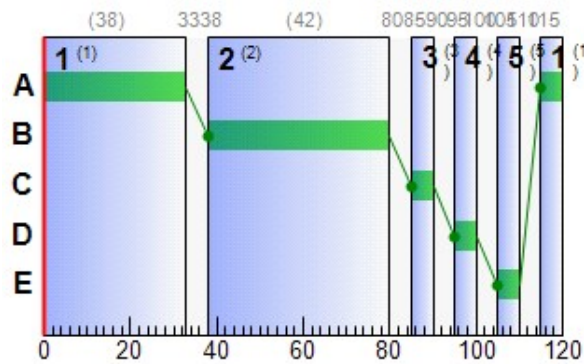

Stage Sequence Diagram for Controller Stream 1

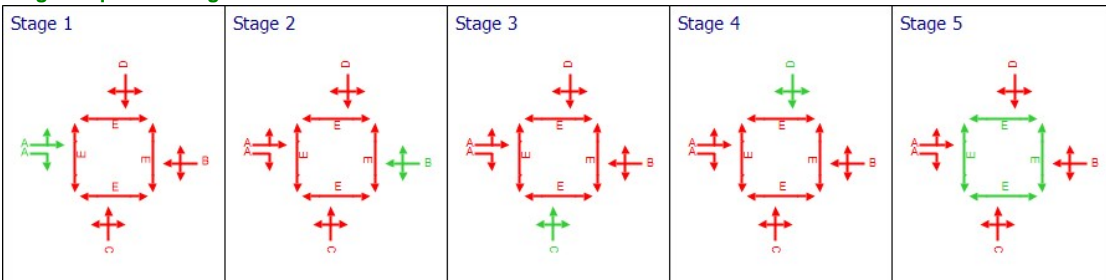

Resultant penalties

Time Segment	Controller stream	Phase min max penalty (£ per hr)	Intergreen broken penalty (£ per hr)	Stage constraint broken penalty (£ per hr)	Cost of controller stream penalties (£ per hr)
08:00-09:00	1	0.00	0.00	0.00	0.00

Traffic Stream Results

Traffic Stream Results: Vehicle summary

Time Segment	Arm	Traffic Stream	Degree of saturation (%)	Practical reserve capacity (%)	Calculated flow entering (Veh/hr)	Calculated sat flow (Veh/hr)	Actual green (s (per cycle))	Mean Delay per Veh (s)	Mean max queue (Veh)	Utilised storage (%)	Weighted cost of delay (£ per hr)	Weighted cost of stops (£ per hr)	Performance Index (£ per hr)
08:00-09:00	A	1	78	28	504	1800	42	43.99	16.20	186.25	87.46	6.00	93.46
	Ax	1	0	Unrestricted	522	Unrestricted	120	0.00	0.00	0.00	0.00	0.00	0.00
	B	1	64	55	58	1800	5	89.73	2.43	27.93	20.53	0.89	21.42
	Bx	1	0	Unrestricted	65	Unrestricted	120	0.00	0.00	0.00	0.00	0.00	0.00
	C	1	80	26	466	1800	38	48.49	15.61	179.53	89.13	5.77	94.90
		2	2	4079	14	1800	38	27.75	0.32	3.63	1.53	0.12	1.65
	Cx	1	0	Unrestricted	471	Unrestricted	120	0.00	0.00	0.00	0.00	0.00	0.00
	D	1	36	181	32	1800	5	66.01	1.13	12.97	8.33	0.42	8.75
Dx	1	0	Unrestricted	16	Unrestricted	120	0.00	0.00	0.00	0.00	0.00	0.00	

Traffic Stream Results: Flows and signals

Time Segment	Arm	Traffic Stream	Calculated flow entering (Veh/hr)	Calculated flow out (Veh/hr)	Flow discrepancy (Veh/hr)	Adjusted flow warning	Calculated sat flow (Veh/hr)	Calculated capacity (Veh/hr)	Degree of saturation (%)	DOS Threshold exceeded	Practical reserve capacity (%)	Mean modulus of error	Actual green (s (per cycle))
08:00-09:00	A	1	504	504	0		1800	645	78		28	0.00	42
	Ax	1	522	522	0		Unrestricted	Unrestricted	0		Unrestricted	1.04	120
	B	1	58	58	0		1800	90	64		55	0.00	5
	Bx	1	65	65	0		Unrestricted	Unrestricted	0		Unrestricted	0.91	120
	C	1	466	466	0		1800	585	80		26	0.00	38
		2	14	14	0		1800	585	2		4079	0.00	38
	Cx	1	471	471	0		Unrestricted	Unrestricted	0		Unrestricted	1.09	120
	D	1	32	32	0		1800	90	36		181	0.00	5
Dx	1	16	16	0		Unrestricted	Unrestricted	0		Unrestricted	0.65	120	

Traffic Stream Results: Stops and delays

Time Segment	Arm	Traffic Stream	Mean Cruise Time per Veh (s)	Mean Delay per Veh (s)	Uniform delay (Veh-hr/hr)	Random plus oversat delay (Veh-hr/hr)	Weighted cost of delay (£ per hr)	Mean stops per Veh (%)	Uniform stops (Stops per hr)	Random stops (Stops per hr)	Weighted cost of stops (£ per hr)
08:00-09:00	A	1	6.00	43.99	4.80	1.36	87.46	94.98	438.86	39.86	6.00
	Ax	1	16.50	0.00	0.00	0.00	0.00	0.00	0.00	0.00	0.00
	B	1	6.00	89.73	0.90	0.54	20.53	122.76	55.98	15.22	0.89
	Bx	1	16.59	0.00	0.00	0.00	0.00	0.00	0.00	0.00	0.00
	C	1	6.00	48.49	4.78	1.50	89.13	98.70	415.96	43.98	5.77
		2	6.00	27.75	0.11	0.00	1.53	66.58	9.31	0.01	0.12
	Cx	1	16.80	0.00	0.00	0.00	0.00	0.00	0.00	0.00	0.00
	D	1	6.00	66.01	0.49	0.10	8.33	104.41	30.58	2.83	0.42
Dx	1	16.45	0.00	0.00	0.00	0.00	0.00	0.00	0.00	0.00	

Traffic Stream Results: Queues and blocking

Time Segment	Arm	Traffic Stream	Initial queue (Veh)	Mean max queue (Veh)	Max queue storage (Veh)	Utilised storage (%)	Average storage excess queue (Veh)	Average limit excess queue (Veh)	Excess queue penalty (£ per hr)	Wasted time starvation (s (per cycle))	Wasted time blocking back (s (per cycle))	Wasted time total (s (per cycle))	Estimated blocking	
08:00-09:00	A	1	0.00	16.20	8.70	186.25	1.71	0.00	0.00	0.00	0.00	0.00		
	Ax	1	0.00	0.00	23.92	0.00	0.00	0.00	0.00	48.00	0.00	48.00		
	B	1	0.00	2.43	8.70	27.93	0.00	0.00	0.00	2.00	0.00	2.00		
	Bx	1	0.00	0.00	24.05	0.00	0.00	0.00	0.00	70.00	0.00	70.00		
	C	1	0.00	15.61	8.70	179.53	1.57	0.00	0.00	0.00	0.00	0.00	0.00	
		2	0.00	0.32	8.70	3.63	0.00	0.00	0.00	0.00	38.00	0.00	38.00	
	Cx	1	0.00	0.00	24.35	0.00	0.00	0.00	0.00	52.00	0.00	52.00		
	D	1	0.00	1.13	8.70	12.97	0.00	0.00	0.00	0.00	3.00	0.00	3.00	
Dx	1	0.00	0.00	23.84	0.00	0.00	0.00	0.00	0.00	120.00	0.00	120.00		

Pedestrian Crossing Results

Pedestrian Crossings: Pedestrian summary

Time Segment	Crossing	Side	Degree of saturation (%)	Calculated Flow Entering (Ped/hr)	Calculated sat flow (Ped/hr)	Actual green (s (per cycle))	Mean Delay Per Ped (s)	Mean max queue (Ped)	Weighted cost of delay (£ per hr)	Performance Index (£ per hr)
08:00-09:00	(ALL)	(ALL)	7	30	11000	5	55.58	0.96	6.58	6.58

Pedestrian Crossings: Flows and signals

Time Segment	Crossing	Side	Calculated flow entering (Ped/hr)	Calculated flow out (Ped/hr)	Flow discrepancy (Ped/hr)	Adjusted flow warning	Calculated sat flow (Ped/hr)	Calculated capacity (Ped/hr)	Degree of saturation (%)	DOS Threshold exceeded	Practical reserve capacity (%)	Mean modulus of error	Actual green (s (per cycle))
08:00-09:00	(ALL)	(ALL)	30	30	0		11000	458	7		1428	0.00	5

Pedestrian Crossings: Stops and delays

Time Segment	Crossing	Side	Mean Cruise Time per Ped (s)	Mean Delay per Ped (s)	Uniform delay (Ped-hr/hr)	Random plus oversat delay (Ped-hr/hr)	Weighted cost of delay (£ per hr)
08:00-09:00	1	1	5.67	55.58	0.46	0.00	6.58
		2	5.67	55.58	0.46	0.00	6.58
	2	1	6.33	55.58	0.46	0.00	6.58
		2	6.33	55.58	0.46	0.00	6.58
	3	1	6.33	55.58	0.46	0.00	6.58
		2	6.33	55.58	0.46	0.00	6.58
	4	1	5.67	55.58	0.46	0.00	6.58
		2	5.67	55.58	0.46	0.00	6.58

Pedestrian Crossings: Queues and blocking

Time Segment	Crossing	Side	Mean max queue (Ped)	Max queue storage (Ped)	Utilised storage (%)	Average storage excess queue (Ped)	Average limit excess queue (Ped)	Excess queue penalty (£ per hr)
08:00-09:00	(ALL)	(ALL)	0.96	10.00	9.58	0.00	0.00	0.00

Network Results

Network Results: Flows and signals

Time Segment	Calculated flow entering (Veh/hr)	Calculated flow out (Veh/hr)	Flow discrepancy (Veh/hr)	Adjusted flow warning	Degree of saturation (%)	DOS Threshold exceeded	Practical reserve capacity (%)	Actual green (s (per cycle))
08:00-09:00	2388	2388	0		80		26	648

Network Results: Stops and delays

Time Segment	Mean Cruise Time per Veh (s)	Mean Delay per Veh (s)	Uniform delay (Veh-hr/hr)	Random plus oversat delay (Veh-hr/hr)	Weighted cost of delay (£ per hr)	Mean stops per Veh (%)	Uniform stops (Stops per hr)	Random stops (Stops per hr)	Weighted cost of stops (£ per hr)
08:00-09:00	10.78	27.56	14.78	3.50	259.60	44.08	950.68	101.90	13.20

Network Results: Queues and blocking

Time Segment	Utilised storage (%)	Excess queue penalty (£ per hr)	Wasted time starvation (s per cycle)	Wasted time blocking back (s per cycle)	Wasted time total (s per cycle)
08:00-09:00	186.25	0.00	333.00	0.00	333.00

Final Prediction Table

Traffic Stream Results

Arm	Traffic Stream	Name	Traffic node	SIGNALS		FLOWS		PERFORMANCE				PER PCU			QUEUES
				Controller stream	Phase	Calculated flow entering (Veh/hr)	Calculated sat flow (Veh/hr)	Actual green (s per cycle)	Wasted time total (s per cycle)	Degree of saturation (%)	Practical reserve capacity (%)	JourneyTime (s)	Mean Delay per Veh (s)	Mean stops per Veh (%)	Mean max queue (Veh)
A	1	(untitled)	1	1	B	504 <	1800	42	0.00	78	28	49.99	43.99	94.98	16.20 +
Ax	1	(untitled)				522	Unrestricted	120	48.00	0	Unrestricted	16.50	0.00	0.00	0.00
B	1	(untitled)	1	1	C	58	1800	5	2.00	64	55	95.73	89.73	122.76	2.43
Bx	1	(untitled)				65	Unrestricted	120	70.00	0	Unrestricted	16.59	0.00	0.00	0.00
C	1	(untitled)	1	1	A	466 <	1800	38	0.00	80	26	54.49	48.49	98.70	15.61 +
	2	(untitled)	1	1	A	14	1800	38	38.00	2	4079	33.75	27.75	66.58	0.32
Cx	1	(untitled)				471	Unrestricted	120	52.00	0	Unrestricted	16.80	0.00	0.00	0.00
D	1	(untitled)	1	1	D	32	1800	5	3.00	36	181	72.01	66.01	104.41	1.13
Dx	1	(untitled)				16	Unrestricted	120	120.00	0	Unrestricted	16.45	0.00	0.00	0.00

Pedestrian Crossing Results

Pedestrian	Side	Name	Traffic node	SIGNALS		FLOWS		PERFORMANCE			PER PED		QUEUES	WEIGHTS	PEN
				Controller stream	Phase	Calculated Flow Entering (Ped/hr)	Calculated sat flow (Ped/hr)	Actual green (s per cycle)	Degree of saturation (%)	Practical reserve capacity (%)	JourneyTime (s)	Mean Delay per Ped (s)	Mean max queue (Ped)	Delay weighting (%)	Co tra pen (£ p)
1	1	(untitled)	1	1	E	30	11000	5	7	1428	61.25	55.58	0.96	100	0
	2	(untitled)	1	1	E	30	11000	5	7	1428	61.25	55.58	0.96	100	0
2	1	(untitled)	1	1	E	30	11000	5	7	1428	61.92	55.58	0.96	100	0
	2	(untitled)	1	1	E	30	11000	5	7	1428	61.92	55.58	0.96	100	0
3	1	(untitled)	1	1	E	30	11000	5	7	1428	61.92	55.58	0.96	100	0
	2	(untitled)	1	1	E	30	11000	5	7	1428	61.92	55.58	0.96	100	0
4	1	(untitled)	1	1	E	30	11000	5	7	1428	61.25	55.58	0.96	100	0
	2	(untitled)	1	1	E	30	11000	5	7	1428	61.25	55.58	0.96	100	0

Network Results

	Distance travelled (PCU-km/hr)	Time spent (PCU-hr/hr)	Mean journey speed (kph)	Uniform delay (Veh-hr/hr)	Random plus oversat delay (Veh-hr/hr)	Weighted cost of delay (£ per hr)	Weighted cost of stops (£ per hr)	Excess queue penalty (£ per hr)	Performance Index (£ per hr)
Normal traffic	202.61	21.33	9.50	11.08	3.50	206.98	13.20	0.00	220.18
Bus	0.00	0.00	0.00	0.00	0.00	0.00	0.00	0.00	0.00
Tram	0.00	0.00	0.00	0.00	0.00	0.00	0.00	0.00	0.00
Pedestrians	2.04	4.11	0.50	3.71	0.00	52.62	0.00	0.00	52.62
TOTAL	204.65	25.44	8.05	14.78	3.50	259.60	13.20	0.00	272.80

- | < = adjusted flow warning (upstream links/traffic streams are over-saturated)
- | * = Traffic Stream - Normal, Bus or Tram Stop or Delay weighting has been set to a value other than 100%
- | ^ = Traffic Stream - Normal, Bus or Tram Stop or Delay Path weighting has been set to a value other than 100%
- | + = average link/traffic stream excess queue is greater than 0
- | **P.I. = PERFORMANCE INDEX**

A6 - DO SOMETHING 2039 D6 - DO SOMETHING 2039*

Summary

Data Errors and Warnings

No errors or warnings

Run Summary

Analysis set used	Run start time	Run finish time	Modelling start time (HH:mm)	Network Cycle Time (s)	Performance Index (£ per hr)	Total network delay (Veh-hr/hr)	Highest DOS (%)	Item with highest DOS	Number of oversaturated items	Percentage of oversaturated items (%)	Item with worst signalised PRC	Item with worst unsignalised PRC	Item with worst over PR
6	19/08/2020 12:11:27	19/08/2020 12:11:27	08:00	120	304.97	20.45	84.96	C/1	0	0	C/1	Dx/1	C/

Analysis Set Details

Name	Description	Demand set	Include in report	Locked
DO SOMETHING 2039	AM	D6	✓	

Demand Set Details

Name	Description	Composite	Demand sets	Start time (HH:mm)	Locked
DO SOMETHING 2039	AM			08:00	

Arms and Traffic Streams

Arms

Arm	Name	Description	Traffic node
A	(untitled)		1
Ax	(untitled)		
B	(untitled)		1
Bx	(untitled)		
C	(untitled)		1
Cx	(untitled)		
D	(untitled)		1
Dx	(untitled)		

Traffic Streams

Arm	Traffic Stream	Name	Description	Auto length	Length (m)	Has Saturation Flow	Saturation flow source	Saturation flow (PCU/hr)	Is signal controlled	Is give way	Traffic type	Allow Nearside Turn On Red
A	1	(untitled)		✓	50.00	✓	Sum of lanes	1800	✓		Normal	
Ax	1	(untitled)		✓	137.53						Normal	
B	1	(untitled)		✓	50.00	✓	Sum of lanes	1800	✓		Normal	
Bx	1	(untitled)		✓	138.27						Normal	
C	1	(untitled)		✓	50.00	✓	Sum of lanes	1800	✓		Normal	
	2	(untitled)		✓	50.00	✓	Sum of lanes	1800	✓		Normal	
Cx	1	(untitled)		✓	140.00						Normal	
D	1	(untitled)		✓	50.00	✓	Sum of lanes	1800	✓		Normal	
Dx	1	(untitled)		✓	137.05						Normal	

Lanes

Arm	Traffic Stream	Lane	Name	Description	Use RR67	Saturation flow (PCU/hr)
A	1	1	(untitled)			1800
Ax	1	1	(untitled)			
B	1	1	(untitled)			1800
Bx	1	1	(untitled)			
C	1	1	(untitled)			1800
	2	1	(untitled)			1800
Cx	1	1	(untitled)			
D	1	1	(untitled)			1800
Dx	1	1	(untitled)			

Modelling

Arm	Traffic Stream	Traffic model	Stop weighting multiplier (%)	Delay weighting multiplier (%)	Assignment Cost Weighting (%)	Exclude from results calculation	Max queue storage (PCU)	Has queue limit	Has degree of saturation limit
(ALL)	(ALL)	NetworkDefault	100	100	100		0.00		

Modelling - Advanced

Arm	Traffic Stream	Initial queue (PCU)	Type of Vehicle-in-Service	Vehicle-in-Service	Type of random parameter	Random parameter	Auto cycle time	Cycle time
(ALL)	(ALL)	0.00	NetworkDefault	Not-Included	NetworkDefault	0.50	✓	120

Normal traffic - Modelling

Arm	Traffic Stream	Stop weighting (%)	Delay weighting (%)
(ALL)	(ALL)	100	100

Normal traffic - Advanced

Arm	Traffic Stream	Dispersion type for Normal Traffic
(ALL)	(ALL)	NetworkDefault

Flows

Arm	Traffic Stream	Total Flow (Veh/hr)	Normal Flow (Veh/hr)
A	1	535	535
Ax	1	553	553
B	1	58	58
Bx	1	65	65
C	1	497	497
	2	14	14
Cx	1	502	502
D	1	32	32
Dx	1	16	16

Signals

Arm	Traffic Stream	Controller stream	Phase	Second phase enabled
A	1	1	B	
B	1	1	C	
C	1	1	A	
	2	1	A	
D	1	1	D	

Pedestrian Crossings

Pedestrian Crossings

Crossing	Name	Description	Traffic node	Allow walk on red	Crossing type	Length (m)	Cruise time (seconds)	Cruise speed (kph)
1	(untitled)		1		Farside	7.00	4.67	5.40
2	(untitled)		1		Farside	8.00	5.33	5.40
3	(untitled)		1		Farside	8.00	5.33	5.40
4	(untitled)		1		Farside	7.00	4.67	5.40

Pedestrian Crossings - Signals

Crossing	Controller stream	Phase	Second phase enabled
(ALL)	1	E	

Pedestrian Crossings - Sides

Crossing	Side	Saturation flow (Ped/hr)
(ALL)	(ALL)	11000

Pedestrian Crossings - Modelling

Crossing	Side	Delay weighting (%)	Assignment Cost Weighting (%)	Exclude from results calculation	Max queue storage (Ped)	Has queue limit	Has degree of saturation limit
(ALL)	(ALL)	100	100		0.00		

Local OD Matrix - Local Matrix: 1

Local Matrix Options

OD Matrix	Name	Use for point to point table	Auto calculate	Allocation mode	Allow paths past exit locations	Allow looped paths on arms	Allow looped paths on traffic nodes	Copy flows	Matrix to copy flows from	Limit paths by length	Path length limit multiplier	Limit paths by number	Path number limit
1	(untitled)	✓	✓	Path Equalisation	✓		✓			✓	1.25		

Normal Input Flows (Veh/hr)

		To							
		1	2	3	4	5	6	7	8
From	1	0	7	490	14	0	0	0	0
	2	14	0	18	0	0	0	0	0
	3	475	9	0	51	0	0	0	0
	4	13	0	45	0	0	0	0	0
	5	0	0	0	0	0	0	0	0
	6	0	0	0	0	0	0	0	0
	7	0	0	0	0	0	0	0	0
	8	0	0	0	0	0	0	0	0

Bus Input Flows not shown as they are blank.

Tram Input Flows not shown as they are blank.

Pedestrian Input Flows (Veh/hr)

From	To							
	1	2	3	4	5	6	7	8
1	0	0	0	0	0	0	0	0
2	0	0	0	0	0	0	0	0
3	0	0	0	0	0	0	0	0
4	0	0	0	0	0	0	0	0
5	0	0	0	0	0	30	30	0
6	0	0	0	0	30	0	0	30
7	0	0	0	0	30	0	0	30
8	0	0	0	0	0	30	30	0

Locations

OD Matrix	Location	Name	Entries	Exits	Colour
1	1	(untitled)	C/1, C/2	Cx/1	#0000FF
	2	(untitled)	D/1	Dx/1	#FF0000
	3	(untitled)	A/1	Ax/1	#00FF00
	4	(untitled)	B/1	Bx/1	#FFFF00
	5	(untitled)	3:2E, 1:1E	3:2X, 1:1X	#FF00FF
	6	(untitled)	2:1E, 1:2E	2:1X, 1:2X	#008000
	7	(untitled)	4:2E, 3:1E	4:2X, 3:1X	#FFA500
	8	(untitled)	4:1E, 2:2E	4:1X, 2:2X	#00FFFF

Normal Paths and Flows

OD Matrix	Path	Description	From location	To location	Path items	Allocation type	Normal Calculated Flow (Veh/hr)
1	1		1	2	C/1, Dx/1	Normal	7
	2		1	3	C/1, Ax/1	Normal	490
	5		2	3	D/1, Ax/1	Normal	18
	6		2	4	D/1, Bx/1	Normal	0
	7		2	1	D/1, Cx/1	Normal	14
	8		3	2	A/1, Dx/1	Normal	9
	9		3	4	A/1, Bx/1	Normal	51
	10		3	1	A/1, Cx/1	Normal	475
	11		4	2	B/1, Dx/1	Normal	0
	12		4	3	B/1, Ax/1	Normal	45
	13		4	1	B/1, Cx/1	Normal	13
	21		1	4	C/2, Bx/1	Normal	14

Pedestrian Paths and Flows

OD Matrix	Path	Description	From location	To location	Path items	Allocation type	Pedestrian calculated flow (Ped/hr)
1	17		8	7	4:1E, 4:2X	Normal	30
	18		8	6	2:2E, 2:1X	Normal	30
	22		5	7	3:2E, 3:1X	Normal	30
	23		5	6	1:1E, 1:2X	Normal	30
	34		6	8	2:1E, 2:2X	Normal	30
	35		6	5	1:2E, 1:1X	Normal	30
	41		7	8	4:2E, 4:1X	Normal	30
	42		7	5	3:1E, 3:2X	Normal	30

Signal Timings

Network Default: 120s cycle time; 120 steps

Controller Stream 1

Controller Stream	Name	Description	Use sequence	Cycle time source	Cycle time (s)
1	(untitled)		1	NetworkDefault	120

Controller Stream 1 - Properties

Controller Stream	Manufacturer name	Type	Model number	(Telephone) Line Number	Site number	Grid reference	Gaining delay type
1	Unspecified						Relative

Controller Stream 1 - Optimisation

Controller Stream	Allow offset optimisation	Allow green split optimisation	Optimisation level	Auto redistribute	Enable stage constraint
1	✓	✓	Offsets And Green Splits	✓	

Phases

Controller Stream	Phase	Name	Minimum green (s)	Maximum green (s)	Relative start displacement (s)	Relative end displacement (s)	Type	Blackout Time (s)
1	A	(untitled)	38	300	0	0	Traffic	
	B	(untitled)	5	300	0	0	Traffic	
	C	(untitled)	5	300	0	0	Traffic	
	D	(untitled)	5	300	0	0	Traffic	
	E	(untitled)	5	300	0	0	Pedestrian	0

Library Stages

Controller Stream	Library Stage	Phases in stage	User stage minimum (s)
1	1	A	1
	2	B	1
	3	C	1
	4	D	1
	5	E	1

Stage Sequences

Controller Stream	Sequence	Name	Multiple cycling	Stage IDs	Stage ends
1	1	(untitled)	Single	1, 2, 3, 4, 5	33, 80, 90, 100, 110

Intergreen Matrix for Controller Stream 1

		To				
		A	B	C	D	E
From	A		5	5	5	5
	B	5		5	5	5
	C	5	5		5	5
	D	5	5	5		5
	E	5	5	5	5	

Banned Stage transitions for Controller Stream 1

		To				
		1	2	3	4	5
From	1					
	2					
	3					
	4					
	5					

Interstage Matrix for Controller Stream 1

		To				
		1	2	3	4	5
From	1	0	5	5	5	5
	2	5	0	5	5	5
	3	5	5	0	5	5
	4	5	5	5	0	5
	5	5	5	5	5	0

Resultant Stages

Controller Stream	Resultant Stage	Is base stage	Library Stage ID	Phases in this stage	Stage start (s)	Stage end (s)	Stage duration (s)	User stage minimum (s)	Stage minimum (s)
1	1	✓	1	A	115	33	38	1	38
	2	✓	2	B	38	80	42	1	5
	3	✓	3	C	85	90	5	1	5
	4	✓	4	D	95	100	5	1	5
	5	✓	5	E	105	110	5	1	5

Resultant Phase Green Periods

Controller Stream	Phase	Green period	Is base green period	Start time (s)	End time (s)	Duration (s)
1	A	1	✓	115	33	38
	B	1	✓	38	80	42
	C	1	✓	85	90	5
	D	1	✓	95	100	5
	E	1	✓	105	110	5

Traffic Stream Green Times

Arm	Traffic Stream	Traffic Node	Controller Stream	Phase	Green Period 1		
					Start	End	Duration
A	1	1	1	B	38	80	42
B	1	1	1	C	85	90	5
C	1	1	1	A	115	33	38
C	2	1	1	A	115	33	38
D	1	1	1	D	95	100	5

Phase Timings Diagram for Controller Stream 1

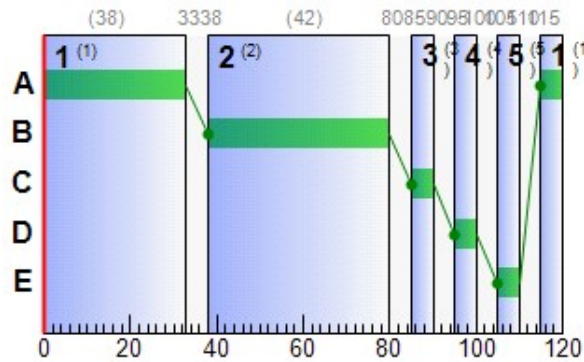

Stage Sequence Diagram for Controller Stream 1

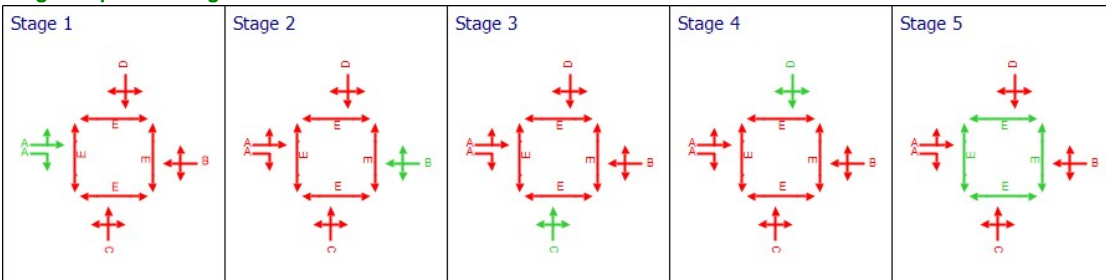

Resultant penalties

Time Segment	Controller stream	Phase min max penalty (£ per hr)	Intergreen broken penalty (£ per hr)	Stage constraint broken penalty (£ per hr)	Cost of controller stream penalties (£ per hr)
08:00-09:00	1	0.00	0.00	0.00	0.00

Traffic Stream Results

Traffic Stream Results: Vehicle summary

Time Segment	Arm	Traffic Stream	Degree of saturation (%)	Practical reserve capacity (%)	Calculated flow entering (Veh/hr)	Calculated sat flow (Veh/hr)	Actual green (s (per cycle))	Mean Delay per Veh (s)	Mean max queue (Veh)	Utilised storage (%)	Weighted cost of delay (£ per hr)	Weighted cost of stops (£ per hr)	Performance Index (£ per hr)
08:00-09:00	A	1	83	21	535	1800	42	48.08	18.12	208.38	101.47	6.70	108.16
	Ax	1	0	Unrestricted	553	Unrestricted	120	0.00	0.00	0.00	0.00	0.00	0.00
	B	1	64	55	58	1800	5	89.73	2.43	27.93	20.53	0.89	21.42
	Bx	1	0	Unrestricted	65	Unrestricted	120	0.00	0.00	0.00	0.00	0.00	0.00
	C	1	85	18	497	1800	38	54.00	17.57	202.01	105.87	6.50	112.37
		2	2	4079	14	1800	38	27.75	0.32	3.63	1.53	0.12	1.65
	Cx	1	0	Unrestricted	502	Unrestricted	120	0.00	0.00	0.00	0.00	0.00	0.00
	D	1	36	181	32	1800	5	66.01	1.13	12.97	8.33	0.42	8.75
Dx	1	0	Unrestricted	16	Unrestricted	120	0.00	0.00	0.00	0.00	0.00	0.00	

Traffic Stream Results: Flows and signals

Time Segment	Arm	Traffic Stream	Calculated flow entering (Veh/hr)	Calculated flow out (Veh/hr)	Flow discrepancy (Veh/hr)	Adjusted flow warning	Calculated sat flow (Veh/hr)	Calculated capacity (Veh/hr)	Degree of saturation (%)	DOS Threshold exceeded	Practical reserve capacity (%)	Mean modulus of error	Actual green (s (per cycle))
08:00-09:00	A	1	535	535	0		1800	645	83		21	0.00	42
	Ax	1	553	553	0		Unrestricted	Unrestricted	0		Unrestricted	1.04	120
	B	1	58	58	0		1800	90	64		55	0.00	5
	Bx	1	65	65	0		Unrestricted	Unrestricted	0		Unrestricted	0.90	120
	C	1	497	497	0		1800	585	85		18	0.00	38
		2	14	14	0		1800	585	2		4079	0.00	38
	Cx	1	502	502	0		Unrestricted	Unrestricted	0		Unrestricted	1.09	120
	D	1	32	32	0		1800	90	36		181	0.00	5
Dx	1	16	16	0		Unrestricted	Unrestricted	0		Unrestricted	0.62	120	

Traffic Stream Results: Stops and delays

Time Segment	Arm	Traffic Stream	Mean Cruise Time per Veh (s)	Mean Delay per Veh (s)	Uniform delay (Veh-hr/hr)	Random plus oversat delay (Veh-hr/hr)	Weighted cost of delay (£ per hr)	Mean stops per Veh (%)	Uniform stops (Stops per hr)	Random stops (Stops per hr)	Weighted cost of stops (£ per hr)
08:00-09:00	A	1	6.00	48.08	5.22	1.92	101.47	99.85	478.11	56.11	6.70
	Ax	1	16.50	0.00	0.00	0.00	0.00	0.00	0.00	0.00	0.00
	B	1	6.00	89.73	0.90	0.54	20.53	122.76	55.98	15.22	0.89
	Bx	1	16.59	0.00	0.00	0.00	0.00	0.00	0.00	0.00	0.00
	C	1	6.00	54.00	5.21	2.24	105.87	104.32	453.43	65.03	6.50
		2	6.00	27.75	0.11	0.00	1.53	66.58	9.31	0.01	0.12
	Cx	1	16.80	0.00	0.00	0.00	0.00	0.00	0.00	0.00	0.00
	D	1	6.00	66.01	0.49	0.10	8.33	104.41	30.58	2.83	0.42
Dx	1	16.45	0.00	0.00	0.00	0.00	0.00	0.00	0.00	0.00	

Traffic Stream Results: Queues and blocking

Time Segment	Arm	Traffic Stream	Initial queue (Veh)	Mean max queue (Veh)	Max queue storage (Veh)	Utilised storage (%)	Average storage excess queue (Veh)	Average limit excess queue (Veh)	Excess queue penalty (£ per hr)	Wasted time starvation (s (per cycle))	Wasted time blocking back (s (per cycle))	Wasted time total (s (per cycle))	Estimated blocking	
08:00-09:00	A	1	0.00	18.12	8.70	208.38	2.53	0.00	0.00	0.00	0.00	0.00		
	Ax	1	0.00	0.00	23.92	0.00	0.00	0.00	0.00	47.00	0.00	47.00		
	B	1	0.00	2.43	8.70	27.93	0.00	0.00	0.00	2.00	0.00	2.00		
	Bx	1	0.00	0.00	24.05	0.00	0.00	0.00	0.00	71.00	0.00	71.00		
	C	1	0.00	17.57	8.70	202.01	2.41	0.00	0.00	0.00	0.00	0.00	0.00	
		2	0.00	0.32	8.70	3.63	0.00	0.00	0.00	0.00	38.00	0.00	38.00	
	Cx	1	0.00	0.00	24.35	0.00	0.00	0.00	0.00	52.00	0.00	52.00		
	D	1	0.00	1.13	8.70	12.97	0.00	0.00	0.00	0.00	3.00	0.00	3.00	
Dx	1	0.00	0.00	23.84	0.00	0.00	0.00	0.00	0.00	120.00	0.00	120.00		

Pedestrian Crossing Results

Pedestrian Crossings: Pedestrian summary

Time Segment	Crossing	Side	Degree of saturation (%)	Calculated Flow Entering (Ped/hr)	Calculated sat flow (Ped/hr)	Actual green (s (per cycle))	Mean Delay Per Ped (s)	Mean max queue (Ped)	Weighted cost of delay (£ per hr)	Performance Index (£ per hr)
08:00-09:00	(ALL)	(ALL)	7	30	11000	5	55.58	0.96	6.58	6.58

Pedestrian Crossings: Flows and signals

Time Segment	Crossing	Side	Calculated flow entering (Ped/hr)	Calculated flow out (Ped/hr)	Flow discrepancy (Ped/hr)	Adjusted flow warning	Calculated sat flow (Ped/hr)	Calculated capacity (Ped/hr)	Degree of saturation (%)	DOS Threshold exceeded	Practical reserve capacity (%)	Mean modulus of error	Actual green (s (per cycle))
08:00-09:00	(ALL)	(ALL)	30	30	0		11000	458	7		1428	0.00	5

Pedestrian Crossings: Stops and delays

Time Segment	Crossing	Side	Mean Cruise Time per Ped (s)	Mean Delay per Ped (s)	Uniform delay (Ped-hr/hr)	Random plus oversat delay (Ped-hr/hr)	Weighted cost of delay (£ per hr)
08:00-09:00	1	1	5.67	55.58	0.46	0.00	6.58
		2	5.67	55.58	0.46	0.00	6.58
	2	1	6.33	55.58	0.46	0.00	6.58
		2	6.33	55.58	0.46	0.00	6.58
	3	1	6.33	55.58	0.46	0.00	6.58
		2	6.33	55.58	0.46	0.00	6.58
	4	1	5.67	55.58	0.46	0.00	6.58
		2	5.67	55.58	0.46	0.00	6.58

Pedestrian Crossings: Queues and blocking

Time Segment	Crossing	Side	Mean max queue (Ped)	Max queue storage (Ped)	Utilised storage (%)	Average storage excess queue (Ped)	Average limit excess queue (Ped)	Excess queue penalty (£ per hr)
08:00-09:00	(ALL)	(ALL)	0.96	10.00	9.58	0.00	0.00	0.00

Network Results

Network Results: Flows and signals

Time Segment	Calculated flow entering (Veh/hr)	Calculated flow out (Veh/hr)	Flow discrepancy (Veh/hr)	Adjusted flow warning	Degree of saturation (%)	DOS Threshold exceeded	Practical reserve capacity (%)	Actual green (s (per cycle))
08:00-09:00	2512	2512	0		85		18	648

Network Results: Stops and delays

Time Segment	Mean Cruise Time per Veh (s)	Mean Delay per Veh (s)	Uniform delay (Veh-hr/hr)	Random plus oversat delay (Veh-hr/hr)	Weighted cost of delay (£ per hr)	Mean stops per Veh (%)	Uniform stops (Stops per hr)	Random stops (Stops per hr)	Weighted cost of stops (£ per hr)
08:00-09:00	10.81	29.30	15.64	4.80	290.35	46.44	1027.41	139.20	14.63

Network Results: Queues and blocking

Time Segment	Utilised storage (%)	Excess queue penalty (£ per hr)	Wasted time starvation (s per cycle))	Wasted time blocking back (s per cycle))	Wasted time total (s per cycle))
08:00-09:00	208.38	0.00	333.00	0.00	333.00

Final Prediction Table

Traffic Stream Results

Arm	Traffic Stream	Name	Traffic node	SIGNALS		FLOWS		PERFORMANCE				PER PCU			QUEUES
				Controller stream	Phase	Calculated flow entering (Veh/hr)	Calculated sat flow (Veh/hr)	Actual green (s per cycle))	Wasted time total (s per cycle))	Degree of saturation (%)	Practical reserve capacity (%)	JourneyTime (s)	Mean Delay per Veh (s)	Mean stops per Veh (%)	Mean max queue (Veh)
A	1	(untitled)	1	1	B	535 <	1800	42	0.00	83	21	54.08	48.08	99.85	18.12 +
Ax	1	(untitled)				553	Unrestricted	120	47.00	0	Unrestricted	16.50	0.00	0.00	0.00
B	1	(untitled)	1	1	C	58	1800	5	2.00	64	55	95.73	89.73	122.76	2.43
Bx	1	(untitled)				65	Unrestricted	120	71.00	0	Unrestricted	16.59	0.00	0.00	0.00
C	1	(untitled)	1	1	A	497 <	1800	38	0.00	85	18	60.00	54.00	104.32	17.57 +
	2	(untitled)	1	1	A	14	1800	38	38.00	2	4079	33.75	27.75	66.58	0.32
Cx	1	(untitled)				502	Unrestricted	120	52.00	0	Unrestricted	16.80	0.00	0.00	0.00
D	1	(untitled)	1	1	D	32	1800	5	3.00	36	181	72.01	66.01	104.41	1.13
Dx	1	(untitled)				16	Unrestricted	120	120.00	0	Unrestricted	16.45	0.00	0.00	0.00

Pedestrian Crossing Results

Pedestrian	Side	Name	Traffic node	SIGNALS		FLOWS		PERFORMANCE			PER PED		QUEUES	WEIGHTS	PEN
				Controller stream	Phase	Calculated Flow Entering (Ped/hr)	Calculated sat flow (Ped/hr)	Actual green (s per cycle))	Degree of saturation (%)	Practical reserve capacity (%)	JourneyTime (s)	Mean Delay per Ped (s)	Mean max queue (Ped)	Delay weighting (%)	Co tra pen (£ p
1	1	(untitled)	1	1	E	30	11000	5	7	1428	61.25	55.58	0.96	100	0
	2	(untitled)	1	1	E	30	11000	5	7	1428	61.25	55.58	0.96	100	0
2	1	(untitled)	1	1	E	30	11000	5	7	1428	61.92	55.58	0.96	100	0
	2	(untitled)	1	1	E	30	11000	5	7	1428	61.92	55.58	0.96	100	0
3	1	(untitled)	1	1	E	30	11000	5	7	1428	61.92	55.58	0.96	100	0
	2	(untitled)	1	1	E	30	11000	5	7	1428	61.92	55.58	0.96	100	0
4	1	(untitled)	1	1	E	30	11000	5	7	1428	61.25	55.58	0.96	100	0
	2	(untitled)	1	1	E	30	11000	5	7	1428	61.25	55.58	0.96	100	0

Network Results

	Distance travelled (PCU-km/hr)	Time spent (PCU-hr/hr)	Mean journey speed (kph)	Uniform delay (Veh-hr/hr)	Random plus oversat delay (Veh-hr/hr)	Weighted cost of delay (£ per hr)	Weighted cost of stops (£ per hr)	Excess queue penalty (£ per hr)	Performance Index (£ per hr)
Normal traffic	214.31	23.89	8.97	11.94	4.80	237.73	14.63	0.00	252.35
Bus	0.00	0.00	0.00	0.00	0.00	0.00	0.00	0.00	0.00
Tram	0.00	0.00	0.00	0.00	0.00	0.00	0.00	0.00	0.00
Pedestrians	2.04	4.11	0.50	3.71	0.00	52.62	0.00	0.00	52.62
TOTAL	216.35	27.99	7.73	15.64	4.80	290.35	14.63	0.00	304.97

- | < = adjusted flow warning (upstream links/traffic streams are over-saturated)
- | * = Traffic Stream - Normal, Bus or Tram Stop or Delay weighting has been set to a value other than 100%
- | ^ = Traffic Stream - Normal, Bus or Tram Stop or Delay Path weighting has been set to a value other than 100%
- | + = average link/traffic stream excess queue is greater than 0
- | **P.I. = PERFORMANCE INDEX**



TRANSYT 15
Version: 15.5.2.7994 © Copyright TRL Limited, 2018
For sales and distribution information, program advice and maintenance, contact TRL: +44 (0)1344 379777 software@trl.co.uk www.trisoftware.co.uk
The users of this computer program for the solution of an engineering problem are in no way relieved of their responsibility for the correctness of the solution

Filename: Junction 4 - PM.t15

Path: M:\Projects\12\12-081A - Dunshaughlin Phase 2 - Civils\Design\Traffic\Modelling AUGUST 2020\Junction 4

Report generation date: 19/08/2020 12:13:42

- »A1 - DO NOTHING 2024 : D1 - DO NOTHING 2024* :
- »A2 - DO NOTHING 2029 : D2 - DO NOTHING 2029* :
- »A3 - DO NOTHING 2039 : D3 - DO NOTHING 2039* :
- »A4 - DO SOMETHING 2024 : D4 - DO SOMETHING 2024* :
- »A5 - DO SOMETHING 2029 : D5 - DO SOMETHING 2029* :
- »A6 - DO SOMETHING 2039 : D6 - DO SOMETHING 2039* :

File summary

File description

File title	(untitled)
Location	
Site number	
UTCRegion	
Driving side	Left
Date	06/12/2011
Version	
Status	(new file)
Identifier	
Client	
Jobnumber	
Enumerator	DOMAINf.silva
Description	

Model and Results

Enable controller offsets	Enable fuel consumption	Enable quick flares	Display journey time results	Display level of service results	Display blocking and starvation results	Display end of red and green queue results	Display excess queue results	Display separate uniform and random results	Display unweighted results	Display TRANSYT 12 style timings	Display effective greens in results	Display Red-With-Amber	Display End-Of-Green Amber
			✓		✓		✓	✓					

Units

Cost units	Speed units	Distance units	Fuel economy units	Fuel rate units	Mass units	Traffic units input	Traffic units results	Flow units	Average delay units	Total delay units	Rate of delay units
£	kph	m	mpg	l/h	kg	Veh	Veh	perHour	s	-Hour	perHour

Sorting

Show names instead of IDs	Sorting direction	Sorting type	Ignore prefixes when sorting	Analysis/demand set sorting	Link grouping	Source grouping	Colour Analysis/Demand Sets
	Ascending	Numerical		ID	Normal	Normal	✓

A1 - DO NOTHING 2024 D1 - DO NOTHING 2024*

Summary

Data Errors and Warnings

No errors or warnings

Run Summary

Analysis set used	Run start time	Run finish time	Modelling start time (HH:mm)	Network Cycle Time (s)	Performance Index (£ per hr)	Total network delay (Veh-hr/hr)	Highest DOS (%)	Item with highest DOS	Number of oversaturated items	Percentage of oversaturated items (%)	Item with worst signalised PRC	Item with worst unsignalised PRC	Item with worst over PR
1	19/08/2020 12:13:11	19/08/2020 12:13:12	17:00	120	155.47	10.45	54.05	C/1	0	0	C/1	Dx/1	C/

Analysis Set Details

Name	Description	Demand set	Include in report	Locked
DO NOTHING 2024	PM	D1	✓	

Demand Set Details

Name	Description	Composite	Demand sets	Start time (HH:mm)	Locked
DO NOTHING 2024	PM			17:00	

Arms and Traffic Streams

Arms

Arm	Name	Description	Traffic node
A	(untitled)		1
Ax	(untitled)		
B	(untitled)		1
Bx	(untitled)		
C	(untitled)		1
Cx	(untitled)		
D	(untitled)		1
Dx	(untitled)		

Traffic Streams

Arm	Traffic Stream	Name	Description	Auto length	Length (m)	Has Saturation Flow	Saturation flow source	Saturation flow (PCU/hr)	Is signal controlled	Is give way	Traffic type	Allow Nearside Turn On Red
A	1	(untitled)		✓	50.00	✓	Sum of lanes	1800	✓		Normal	
Ax	1	(untitled)		✓	137.53						Normal	
B	1	(untitled)		✓	50.00	✓	Sum of lanes	1800	✓		Normal	
Bx	1	(untitled)		✓	138.27						Normal	
C	1	(untitled)		✓	50.00	✓	Sum of lanes	1800	✓		Normal	
	2	(untitled)		✓	50.00	✓	Sum of lanes	1800	✓		Normal	
Cx	1	(untitled)		✓	140.00						Normal	
D	1	(untitled)		✓	50.00	✓	Sum of lanes	1800	✓		Normal	
Dx	1	(untitled)		✓	137.05						Normal	

Lanes

Arm	Traffic Stream	Lane	Name	Description	Use RR67	Saturation flow (PCU/hr)
A	1	1	(untitled)			1800
Ax	1	1	(untitled)			
B	1	1	(untitled)			1800
Bx	1	1	(untitled)			
C	1	1	(untitled)			1800
	2	1	(untitled)			1800
Cx	1	1	(untitled)			
D	1	1	(untitled)			1800
Dx	1	1	(untitled)			

Modelling

Arm	Traffic Stream	Traffic model	Stop weighting multiplier (%)	Delay weighting multiplier (%)	Assignment Cost Weighting (%)	Exclude from results calculation	Max queue storage (PCU)	Has queue limit	Has degree of saturation limit
(ALL)	(ALL)	NetworkDefault	100	100	100		0.00		

Modelling - Advanced

Arm	Traffic Stream	Initial queue (PCU)	Type of Vehicle-in-Service	Vehicle-in-Service	Type of random parameter	Random parameter	Auto cycle time	Cycle time
(ALL)	(ALL)	0.00	NetworkDefault	Not-Included	NetworkDefault	0.50	✓	120

Normal traffic - Modelling

Arm	Traffic Stream	Stop weighting (%)	Delay weighting (%)
(ALL)	(ALL)	100	100

Normal traffic - Advanced

Arm	Traffic Stream	Dispersion type for Normal Traffic
(ALL)	(ALL)	NetworkDefault

Flows

Arm	Traffic Stream	Total Flow (Veh/hr)	Normal Flow (Veh/hr)
A	1	378	378
Ax	1	292	292
B	1	6	6
Bx	1	9	9
C	1	300	300
	2	2	2
Cx	1	373	373
D	1	21	21
Dx	1	33	33

Signals

Arm	Traffic Stream	Controller stream	Phase	Second phase enabled
A	1	1	B	
B	1	1	C	
C	1	1	A	
	2	1	A	
D	1	1	D	

Pedestrian Crossings

Pedestrian Crossings

Crossing	Name	Description	Traffic node	Allow walk on red	Crossing type	Length (m)	Cruise time (seconds)	Cruise speed (kph)
1	(untitled)		1		Farside	7.00	4.67	5.40
2	(untitled)		1		Farside	8.00	5.33	5.40
3	(untitled)		1		Farside	8.00	5.33	5.40
4	(untitled)		1		Farside	7.00	4.67	5.40

Pedestrian Crossings - Signals

Crossing	Controller stream	Phase	Second phase enabled
(ALL)	1	E	

Pedestrian Crossings - Sides

Crossing	Side	Saturation flow (Ped/hr)
(ALL)	(ALL)	11000

Pedestrian Crossings - Modelling

Crossing	Side	Delay weighting (%)	Assignment Cost Weighting (%)	Exclude from results calculation	Max queue storage (Ped)	Has queue limit	Has degree of saturation limit
(ALL)	(ALL)	100	100		0.00		

Local OD Matrix - Local Matrix: 1

Local Matrix Options

OD Matrix	Name	Use for point to point table	Auto calculate	Allocation mode	Allow paths past exit locations	Allow looped paths on arms	Allow looped paths on traffic nodes	Copy flows	Matrix to copy flows from	Limit paths by length	Path length limit multiplier	Limit paths by number	Path number limit
1	(untitled)	✓	✓	Path Equalisation	✓		✓			✓	1.25		

Normal Input Flows (Veh/hr)

		To							
		1	2	3	4	5	6	7	8
From	1	0	21	279	2	0	0	0	0
	2	13	0	8	0	0	0	0	0
	3	359	12	0	7	0	0	0	0
	4	1	0	5	0	0	0	0	0
	5	0	0	0	0	0	0	0	0
	6	0	0	0	0	0	0	0	0
	7	0	0	0	0	0	0	0	0
	8	0	0	0	0	0	0	0	0

Bus Input Flows not shown as they are blank.

Tram Input Flows not shown as they are blank.

Pedestrian Input Flows (Veh/hr)

From	To							
	1	2	3	4	5	6	7	8
1	0	0	0	0	0	0	0	0
2	0	0	0	0	0	0	0	0
3	0	0	0	0	0	0	0	0
4	0	0	0	0	0	0	0	0
5	0	0	0	0	0	30	30	0
6	0	0	0	0	30	0	0	30
7	0	0	0	0	30	0	0	30
8	0	0	0	0	0	30	30	0

Locations

OD Matrix	Location	Name	Entries	Exits	Colour
1	1	(untitled)	C/1, C/2	Cx/1	#0000FF
	2	(untitled)	D/1	Dx/1	#FF0000
	3	(untitled)	A/1	Ax/1	#00FF00
	4	(untitled)	B/1	Bx/1	#FFFF00
	5	(untitled)	3:2E, 1:1E	3:2X, 1:1X	#FF00FF
	6	(untitled)	2:1E, 1:2E	2:1X, 1:2X	#008000
	7	(untitled)	4:2E, 3:1E	4:2X, 3:1X	#FFA500
	8	(untitled)	4:1E, 2:2E	4:1X, 2:2X	#00FFFF

Normal Paths and Flows

OD Matrix	Path	Description	From location	To location	Path items	Allocation type	Normal Calculated Flow (Veh/hr)
1	1		1	2	C/1, Dx/1	Normal	21
	2		1	3	C/1, Ax/1	Normal	279
	5		2	3	D/1, Ax/1	Normal	8
	6		2	4	D/1, Bx/1	Normal	0
	7		2	1	D/1, Cx/1	Normal	13
	8		3	2	A/1, Dx/1	Normal	12
	9		3	4	A/1, Bx/1	Normal	7
	10		3	1	A/1, Cx/1	Normal	359
	11		4	2	B/1, Dx/1	Normal	0
	12		4	3	B/1, Ax/1	Normal	5
	13		4	1	B/1, Cx/1	Normal	1
	21		1	4	C/2, Bx/1	Normal	2

Pedestrian Paths and Flows

OD Matrix	Path	Description	From location	To location	Path items	Allocation type	Pedestrian calculated flow (Ped/hr)
1	17		8	7	4:1E, 4:2X	Normal	30
	18		8	6	2:2E, 2:1X	Normal	30
	22		5	7	3:2E, 3:1X	Normal	30
	23		5	6	1:1E, 1:2X	Normal	30
	34		6	8	2:1E, 2:2X	Normal	30
	35		6	5	1:2E, 1:1X	Normal	30
	41		7	8	4:2E, 4:1X	Normal	30
	42		7	5	3:1E, 3:2X	Normal	30

Signal Timings

Network Default: 120s cycle time; 120 steps

Controller Stream 1

Controller Stream	Name	Description	Use sequence	Cycle time source	Cycle time (s)
1	(untitled)		1	NetworkDefault	120

Controller Stream 1 - Properties

Controller Stream	Manufacturer name	Type	Model number	(Telephone) Line Number	Site number	Grid reference	Gaining delay type
1	Unspecified						Relative

Controller Stream 1 - Optimisation

Controller Stream	Allow offset optimisation	Allow green split optimisation	Optimisation level	Auto redistribute	Enable stage constraint
1	✓	✓	Offsets And Green Splits	✓	

Phases

Controller Stream	Phase	Name	Minimum green (s)	Maximum green (s)	Relative start displacement (s)	Relative end displacement (s)	Type	Blackout Time (s)
1	A	(untitled)	0	300	0	0	Traffic	
	B	(untitled)	0	300	0	0	Traffic	
	C	(untitled)	0	300	0	0	Traffic	
	D	(untitled)	0	5	0	0	Traffic	
	E	(untitled)	5	5	0	0	Pedestrian	0

Library Stages

Controller Stream	Library Stage	Phases in stage	User stage minimum (s)
1	1	A	1
	2	B	1
	3	C	1
	4	D	1
	5	E	1

Stage Sequences

Controller Stream	Sequence	Name	Multiple cycling	Stage IDs	Stage ends
1	1	(untitled)	Single	1, 2, 3, 4, 5	23, 76, 82, 92, 102

Intergreen Matrix for Controller Stream 1

		To				
		A	B	C	D	E
From	A		5	5	5	5
	B	5		5	5	5
	C	5	5		5	5
	D	5	5	5		5
	E	5	5	5	5	

Banned Stage transitions for Controller Stream 1

		To				
		1	2	3	4	5
From	1					
	2					
	3					
	4					
	5					

Interstage Matrix for Controller Stream 1

		To				
		1	2	3	4	5
From	1	0	5	5	5	5
	2	5	0	5	5	5
	3	5	5	0	5	5
	4	5	5	5	0	5
	5	5	5	5	5	0

Resultant Stages

Controller Stream	Resultant Stage	Is base stage	Library Stage ID	Phases in this stage	Stage start (s)	Stage end (s)	Stage duration (s)	User stage minimum (s)	Stage minimum (s)
1	1	✓	1	A	107	23	36	1	1
	2	✓	2	B	28	76	48	1	1
	3	✓	3	C	81	82	1	1	1
	4	✓	4	D	87	92	5	1	1
	5	✓	5	E	97	102	5	1	5

Resultant Phase Green Periods

Controller Stream	Phase	Green period	Is base green period	Start time (s)	End time (s)	Duration (s)
1	A	1	✓	107	23	36
	B	1	✓	28	76	48
	C	1	✓	81	82	1
	D	1	✓	87	92	5
	E	1	✓	97	102	5

Traffic Stream Green Times

Arm	Traffic Stream	Traffic Node	Controller Stream	Phase	Green Period 1		
					Start	End	Duration
A	1	1	1	B	28	76	48
B	1	1	1	C	81	82	1
C	1	1	1	A	107	23	36
C	2	1	1	A	107	23	36
D	1	1	1	D	87	92	5

Phase Timings Diagram for Controller Stream 1

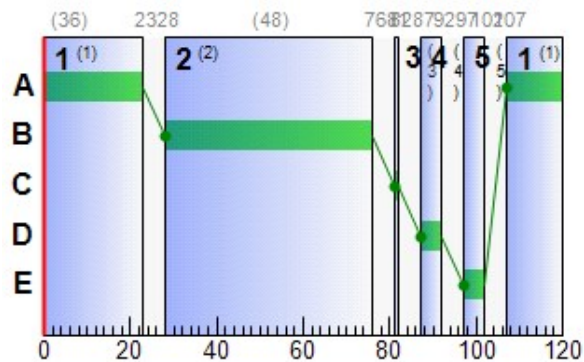

Stage Sequence Diagram for Controller Stream 1

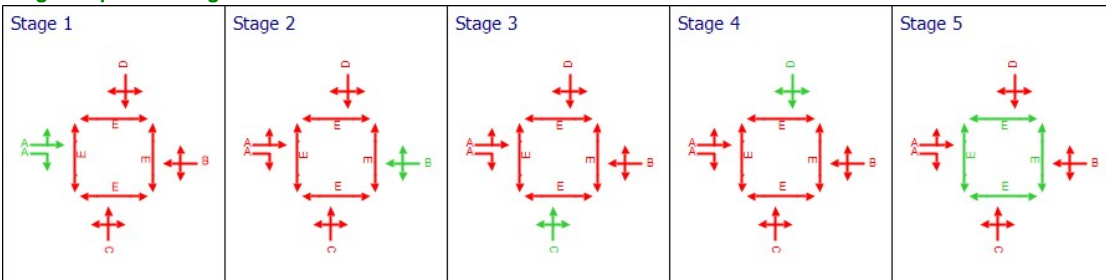

Resultant penalties

Time Segment	Controller stream	Phase min max penalty (£ per hr)	Intergreen broken penalty (£ per hr)	Stage constraint broken penalty (£ per hr)	Cost of controller stream penalties (£ per hr)
17:00-18:00	1	0.00	0.00	0.00	0.00

Traffic Stream Results

Traffic Stream Results: Vehicle summary

Time Segment	Arm	Traffic Stream	Degree of saturation (%)	Practical reserve capacity (%)	Calculated flow entering (Veh/hr)	Calculated sat flow (Veh/hr)	Actual green (s per cycle)	Mean Delay per Veh (s)	Mean max queue (Veh)	Utilised storage (%)	Weighted cost of delay (£ per hr)	Weighted cost of stops (£ per hr)	Performance Index (£ per hr)
17:00-18:00	A	1	51	94	378	1800	48	29.17	9.62	110.58	43.49	3.56	47.06
	Ax	1	0	Unrestricted	292	Unrestricted	120	0.00	0.00	0.00	0.00	0.00	0.00
	B	1	20	400	6	1800	1	73.23	0.22	2.54	1.73	0.08	1.82
	Bx	1	0	Unrestricted	9	Unrestricted	120	0.00	0.00	0.00	0.00	0.00	0.00
	C	1	54	85	300	1800	36	38.24	8.57	98.51	45.25	3.18	48.43
		2	0	27650	2	1800	36	29.06	0.00	0.00	0.23	0.02	0.25
	Cx	1	0	Unrestricted	373	Unrestricted	120	0.00	0.00	0.00	0.00	0.00	0.00
	D	1	23	329	21	1800	5	60.91	0.71	8.12	5.05	0.26	5.31
Dx	1	0	Unrestricted	33	Unrestricted	120	0.00	0.00	0.00	0.00	0.00	0.00	

Traffic Stream Results: Flows and signals

Time Segment	Arm	Traffic Stream	Calculated flow entering (Veh/hr)	Calculated flow out (Veh/hr)	Flow discrepancy (Veh/hr)	Adjusted flow warning	Calculated sat flow (Veh/hr)	Calculated capacity (Veh/hr)	Degree of saturation (%)	DOS Threshold exceeded	Practical reserve capacity (%)	Mean modulus of error	Actual green (s per cycle)
17:00-18:00	A	1	378	378	0		1800	735	51		94	0.00	48
	Ax	1	292	292	0		Unrestricted	Unrestricted	0		Unrestricted	1.22	120
	B	1	6	6	0		1800	30	20		400	0.00	1
	Bx	1	9	9	0		Unrestricted	Unrestricted	0		Unrestricted	0.86	120
	C	1	300	300	0		1800	555	54		85	0.00	36
		2	2	2	0		1800	555	0		27650	0.00	36
	Cx	1	373	373	0		Unrestricted	Unrestricted	0		Unrestricted	1.04	120
	D	1	21	21	0		1800	90	23		329	0.00	5
Dx	1	33	33	0		Unrestricted	Unrestricted	0		Unrestricted	0.79	120	

Traffic Stream Results: Stops and delays

Time Segment	Arm	Traffic Stream	Mean Cruise Time per Veh (s)	Mean Delay per Veh (s)	Uniform delay (Veh-hr/hr)	Random plus oversat delay (Veh-hr/hr)	Weighted cost of delay (£ per hr)	Mean stops per Veh (%)	Uniform stops (Stops per hr)	Random stops (Stops per hr)	Weighted cost of stops (£ per hr)
17:00-18:00	A	1	6.00	29.17	2.79	0.27	43.49	75.17	276.04	8.09	3.56
	Ax	1	16.50	0.00	0.00	0.00	0.00	0.00	0.00	0.00	0.00
	B	1	6.00	73.23	0.10	0.02	1.73	109.25	5.84	0.71	0.08
	Bx	1	16.59	0.00	0.00	0.00	0.00	0.00	0.00	0.00	0.00
	C	1	6.00	38.24	2.87	0.32	45.25	84.49	244.06	9.40	3.18
		2	6.00	29.06	0.02	0.00	0.23	68.18	1.36	0.00	0.02
	Cx	1	16.80	0.00	0.00	0.00	0.00	0.00	0.00	0.00	0.00
	D	1	6.00	60.91	0.32	0.04	5.05	99.82	19.92	1.04	0.26
Dx	1	16.45	0.00	0.00	0.00	0.00	0.00	0.00	0.00	0.00	

Traffic Stream Results: Queues and blocking

Time Segment	Arm	Traffic Stream	Initial queue (Veh)	Mean max queue (Veh)	Max queue storage (Veh)	Utilised storage (%)	Average storage excess queue (Veh)	Average limit excess queue (Veh)	Excess queue penalty (£ per hr)	Wasted time starvation (s (per cycle))	Wasted time blocking back (s (per cycle))	Wasted time total (s (per cycle))	Estimated blocking
17:00-18:00	A	1	0.00	9.62	8.70	110.58	0.04	0.00	0.00	0.00	0.00	0.00	
	Ax	1	0.00	0.00	23.92	0.00	0.00	0.00	0.00	65.00	0.00	65.00	
	B	1	0.00	0.22	8.70	2.54	0.00	0.00	0.00	1.00	0.00	1.00	
	Bx	1	0.00	0.00	24.05	0.00	0.00	0.00	0.00	120.00	0.00	120.00	
	C	1	0.00	8.57	8.70	98.51	0.00	0.00	0.00	0.00	0.00	0.00	
		2	0.00	0.00	8.70	0.00	0.00	0.00	0.00	0.00	36.00	0.00	36.00
	Cx	1	0.00	0.00	24.35	0.00	0.00	0.00	0.00	51.00	0.00	51.00	
	D	1	0.00	0.71	8.70	8.12	0.00	0.00	0.00	0.00	4.00	0.00	4.00
Dx	1	0.00	0.00	23.84	0.00	0.00	0.00	0.00	0.00	102.00	0.00	102.00	

Pedestrian Crossing Results

Pedestrian Crossings: Pedestrian summary

Time Segment	Crossing	Side	Degree of saturation (%)	Calculated Flow Entering (Ped/hr)	Calculated sat flow (Ped/hr)	Actual green (s (per cycle))	Mean Delay Per Ped (s)	Mean max queue (Ped)	Weighted cost of delay (£ per hr)	Performance Index (£ per hr)
17:00-18:00	(ALL)	(ALL)	7	30	11000	5	55.58	0.96	6.58	6.58

Pedestrian Crossings: Flows and signals

Time Segment	Crossing	Side	Calculated flow entering (Ped/hr)	Calculated flow out (Ped/hr)	Flow discrepancy (Ped/hr)	Adjusted flow warning	Calculated sat flow (Ped/hr)	Calculated capacity (Ped/hr)	Degree of saturation (%)	DOS Threshold exceeded	Practical reserve capacity (%)	Mean modulus of error	Actual green (s (per cycle))
17:00-18:00	(ALL)	(ALL)	30	30	0		11000	458	7		1428	0.00	5

Pedestrian Crossings: Stops and delays

Time Segment	Crossing	Side	Mean Cruise Time per Ped (s)	Mean Delay per Ped (s)	Uniform delay (Ped-hr/hr)	Random plus oversat delay (Ped-hr/hr)	Weighted cost of delay (£ per hr)
17:00-18:00	1	1	5.67	55.58	0.46	0.00	6.58
		2	5.67	55.58	0.46	0.00	6.58
	2	1	6.33	55.58	0.46	0.00	6.58
		2	6.33	55.58	0.46	0.00	6.58
	3	1	6.33	55.58	0.46	0.00	6.58
		2	6.33	55.58	0.46	0.00	6.58
	4	1	5.67	55.58	0.46	0.00	6.58
		2	5.67	55.58	0.46	0.00	6.58

Pedestrian Crossings: Queues and blocking

Time Segment	Crossing	Side	Mean max queue (Ped)	Max queue storage (Ped)	Utilised storage (%)	Average storage excess queue (Ped)	Average limit excess queue (Ped)	Excess queue penalty (£ per hr)
17:00-18:00	(ALL)	(ALL)	0.96	10.00	9.58	0.00	0.00	0.00

Network Results

Network Results: Flows and signals

Time Segment	Calculated flow entering (Veh/hr)	Calculated flow out (Veh/hr)	Flow discrepancy (Veh/hr)	Adjusted flow warning	Degree of saturation (%)	DOS Threshold exceeded	Practical reserve capacity (%)	Actual green (s (per cycle))
17:00-18:00	1654	1654	0		54		85	646

Network Results: Stops and delays

Time Segment	Mean Cruise Time per Veh (s)	Mean Delay per Veh (s)	Uniform delay (Veh-hr/hr)	Random plus oversat delay (Veh-hr/hr)	Weighted cost of delay (£ per hr)	Mean stops per Veh (%)	Uniform stops (Stops per hr)	Random stops (Stops per hr)	Weighted cost of stops (£ per hr)
17:00-18:00	10.56	22.74	9.80	0.65	148.37	34.25	547.22	19.25	7.10

Network Results: Queues and blocking

Time Segment	Utilised storage (%)	Excess queue penalty (£ per hr)	Wasted time starvation (s per cycle))	Wasted time blocking back (s per cycle))	Wasted time total (s per cycle))
17:00-18:00	110.58	0.00	379.00	0.00	379.00

Final Prediction Table

Traffic Stream Results

Arm	Traffic Stream	Name	Traffic node	SIGNALS		FLOWS		PERFORMANCE				PER PCU			QUEUES
				Controller stream	Phase	Calculated flow entering (Veh/hr)	Calculated sat flow (Veh/hr)	Actual green (s per cycle))	Wasted time total (s per cycle))	Degree of saturation (%)	Practical reserve capacity (%)	JourneyTime (s)	Mean Delay per Veh (s)	Mean stops per Veh (%)	Mean max queue (Veh)
A	1	(untitled)	1	1	B	378 <	1800	48	0.00	51	94	35.17	29.17	75.17	9.62 +
Ax	1	(untitled)				292	Unrestricted	120	65.00	0	Unrestricted	16.50	0.00	0.00	0.00
B	1	(untitled)	1	1	C	6	1800	1	1.00	20	400	79.23	73.23	109.25	0.22
Bx	1	(untitled)				9	Unrestricted	120	120.00	0	Unrestricted	16.59	0.00	0.00	0.00
C	1	(untitled)	1	1	A	300	1800	36	0.00	54	85	44.24	38.24	84.49	8.57
	2	(untitled)	1	1	A	2	1800	36	36.00	0	27650	35.06	29.06	68.18	0.00
Cx	1	(untitled)				373	Unrestricted	120	51.00	0	Unrestricted	16.80	0.00	0.00	0.00
D	1	(untitled)	1	1	D	21	1800	5	4.00	23	329	66.91	60.91	99.82	0.71
Dx	1	(untitled)				33	Unrestricted	120	102.00	0	Unrestricted	16.45	0.00	0.00	0.00

Pedestrian Crossing Results

Pedestrian	Side	Name	Traffic node	SIGNALS		FLOWS		PERFORMANCE			PER PED		QUEUES	WEIGHTS	PEN
				Controller stream	Phase	Calculated Flow Entering (Ped/hr)	Calculated sat flow (Ped/hr)	Actual green (s per cycle))	Degree of saturation (%)	Practical reserve capacity (%)	JourneyTime (s)	Mean Delay per Ped (s)	Mean max queue (Ped)	Delay weighting (%)	Co tra pen (£ p
1	1	(untitled)	1	1	E	30	11000	5	7	1428	61.25	55.58	0.96	100	0
	2	(untitled)	1	1	E	30	11000	5	7	1428	61.25	55.58	0.96	100	0
2	1	(untitled)	1	1	E	30	11000	5	7	1428	61.92	55.58	0.96	100	0
	2	(untitled)	1	1	E	30	11000	5	7	1428	61.92	55.58	0.96	100	0
3	1	(untitled)	1	1	E	30	11000	5	7	1428	61.92	55.58	0.96	100	0
	2	(untitled)	1	1	E	30	11000	5	7	1428	61.92	55.58	0.96	100	0
4	1	(untitled)	1	1	E	30	11000	5	7	1428	61.25	55.58	0.96	100	0
	2	(untitled)	1	1	E	30	11000	5	7	1428	61.25	55.58	0.96	100	0

Network Results

	Distance travelled (PCU-km/hr)	Time spent (PCU-hr/hr)	Mean journey speed (kph)	Uniform delay (Veh-hr/hr)	Random plus oversat delay (Veh-hr/hr)	Weighted cost of delay (£ per hr)	Weighted cost of stops (£ per hr)	Excess queue penalty (£ per hr)	Performance Index (£ per hr)
Normal traffic	133.50	11.19	11.93	6.10	0.65	95.75	7.10	0.00	102.86
Bus	0.00	0.00	0.00	0.00	0.00	0.00	0.00	0.00	0.00
Tram	0.00	0.00	0.00	0.00	0.00	0.00	0.00	0.00	0.00
Pedestrians	2.04	4.11	0.50	3.71	0.00	52.62	0.00	0.00	52.62
TOTAL	135.54	15.30	8.86	9.80	0.65	148.37	7.10	0.00	155.47

- | < = adjusted flow warning (upstream links/traffic streams are over-saturated)
- | * = Traffic Stream - Normal, Bus or Tram Stop or Delay weighting has been set to a value other than 100%
- | ^ = Traffic Stream - Normal, Bus or Tram Stop or Delay Path weighting has been set to a value other than 100%
- | + = average link/traffic stream excess queue is greater than 0
- | **P.I. = PERFORMANCE INDEX**

A2 - DO NOTHING 2029 D2 - DO NOTHING 2029*

Summary

Data Errors and Warnings

No errors or warnings

Run Summary

Analysis set used	Run start time	Run finish time	Modelling start time (HH:mm)	Network Cycle Time (s)	Performance Index (£ per hr)	Total network delay (Veh-hr/hr)	Highest DOS (%)	Item with highest DOS	Number of oversaturated items	Percentage of oversaturated items (%)	Item with worst signalised PRC	Item with worst unsignalised PRC	Item with worst over PR
2	19/08/2020 12:13:12	19/08/2020 12:13:13	17:00	120	201.67	13.53	65.52	C/1	0	0	C/1	Dx/1	C/

Analysis Set Details

Name	Description	Demand set	Include in report	Locked
DO NOTHING 2029	PM	D2	✓	

Demand Set Details

Name	Description	Composite	Demand sets	Start time (HH:mm)	Locked
DO NOTHING 2029	PM			17:00	

Arms and Traffic Streams

Arms

Arm	Name	Description	Traffic node
A	(untitled)		1
Ax	(untitled)		
B	(untitled)		1
Bx	(untitled)		
C	(untitled)		1
Cx	(untitled)		
D	(untitled)		1
Dx	(untitled)		

Traffic Streams

Arm	Traffic Stream	Name	Description	Auto length	Length (m)	Has Saturation Flow	Saturation flow source	Saturation flow (PCU/hr)	Is signal controlled	Is give way	Traffic type	Allow Nearside Turn On Red
A	1	(untitled)		✓	50.00	✓	Sum of lanes	1800	✓		Normal	
Ax	1	(untitled)		✓	137.53						Normal	
B	1	(untitled)		✓	50.00	✓	Sum of lanes	1800	✓		Normal	
Bx	1	(untitled)		✓	138.27						Normal	
C	1	(untitled)		✓	50.00	✓	Sum of lanes	1800	✓		Normal	
	2	(untitled)		✓	50.00	✓	Sum of lanes	1800	✓		Normal	
Cx	1	(untitled)		✓	140.00						Normal	
D	1	(untitled)		✓	50.00	✓	Sum of lanes	1800	✓		Normal	
Dx	1	(untitled)		✓	137.05						Normal	

Lanes

Arm	Traffic Stream	Lane	Name	Description	Use RR67	Saturation flow (PCU/hr)
A	1	1	(untitled)			1800
Ax	1	1	(untitled)			
B	1	1	(untitled)			1800
Bx	1	1	(untitled)			
C	1	1	(untitled)			1800
	2	1	(untitled)			1800
Cx	1	1	(untitled)			
D	1	1	(untitled)			1800
Dx	1	1	(untitled)			

Modelling

Arm	Traffic Stream	Traffic model	Stop weighting multiplier (%)	Delay weighting multiplier (%)	Assignment Cost Weighting (%)	Exclude from results calculation	Max queue storage (PCU)	Has queue limit	Has degree of saturation limit
(ALL)	(ALL)	NetworkDefault	100	100	100		0.00		

Modelling - Advanced

Arm	Traffic Stream	Initial queue (PCU)	Type of Vehicle-in-Service	Vehicle-in-Service	Type of random parameter	Random parameter	Auto cycle time	Cycle time
(ALL)	(ALL)	0.00	NetworkDefault	Not-Included	NetworkDefault	0.50	✓	120

Normal traffic - Modelling

Arm	Traffic Stream	Stop weighting (%)	Delay weighting (%)
(ALL)	(ALL)	100	100

Normal traffic - Advanced

Arm	Traffic Stream	Dispersion type for Normal Traffic
(ALL)	(ALL)	NetworkDefault

Flows

Arm	Traffic Stream	Total Flow (Veh/hr)	Normal Flow (Veh/hr)
A	1	447	447
Ax	1	374	374
B	1	54	54
Bx	1	40	40
C	1	344	344
	2	8	8
Cx	1	427	427
D	1	21	21
Dx	1	33	33

Signals

Arm	Traffic Stream	Controller stream	Phase	Second phase enabled
A	1	1	B	
B	1	1	C	
C	1	1	A	
	2	1	A	
D	1	1	D	

Pedestrian Crossings

Pedestrian Crossings

Crossing	Name	Description	Traffic node	Allow walk on red	Crossing type	Length (m)	Cruise time (seconds)	Cruise speed (kph)
1	(untitled)		1		Farside	7.00	4.67	5.40
2	(untitled)		1		Farside	8.00	5.33	5.40
3	(untitled)		1		Farside	8.00	5.33	5.40
4	(untitled)		1		Farside	7.00	4.67	5.40

Pedestrian Crossings - Signals

Crossing	Controller stream	Phase	Second phase enabled
(ALL)	1	E	

Pedestrian Crossings - Sides

Crossing	Side	Saturation flow (Ped/hr)
(ALL)	(ALL)	11000

Pedestrian Crossings - Modelling

Crossing	Side	Delay weighting (%)	Assignment Cost Weighting (%)	Exclude from results calculation	Max queue storage (Ped)	Has queue limit	Has degree of saturation limit
(ALL)	(ALL)	100	100		0.00		

Local OD Matrix - Local Matrix: 1

Local Matrix Options

OD Matrix	Name	Use for point to point table	Auto calculate	Allocation mode	Allow paths past exit locations	Allow looped paths on arms	Allow looped paths on traffic nodes	Copy flows	Matrix to copy flows from	Limit paths by length	Path length limit multiplier	Limit paths by number	Path number limit
1	(untitled)	✓	✓	Path Equalisation	✓		✓			✓	1.25		

Normal Input Flows (Veh/hr)

		To							
		1	2	3	4	5	6	7	8
From	1	0	21	323	8	0	0	0	0
	2	13	0	8	0	0	0	0	0
	3	403	12	0	32	0	0	0	0
	4	11	0	43	0	0	0	0	0
	5	0	0	0	0	0	0	0	0
	6	0	0	0	0	0	0	0	0
	7	0	0	0	0	0	0	0	0
	8	0	0	0	0	0	0	0	0

Bus Input Flows not shown as they are blank.

Tram Input Flows not shown as they are blank.

Pedestrian Input Flows (Veh/hr)

From	To							
	1	2	3	4	5	6	7	8
1	0	0	0	0	0	0	0	0
2	0	0	0	0	0	0	0	0
3	0	0	0	0	0	0	0	0
4	0	0	0	0	0	0	0	0
5	0	0	0	0	0	30	30	0
6	0	0	0	0	30	0	0	30
7	0	0	0	0	30	0	0	30
8	0	0	0	0	0	30	30	0

Locations

OD Matrix	Location	Name	Entries	Exits	Colour
1	1	(untitled)	C/1, C/2	Cx/1	#0000FF
	2	(untitled)	D/1	Dx/1	#FF0000
	3	(untitled)	A/1	Ax/1	#00FF00
	4	(untitled)	B/1	Bx/1	#FFFF00
	5	(untitled)	3:2E, 1:1E	3:2X, 1:1X	#FF00FF
	6	(untitled)	2:1E, 1:2E	2:1X, 1:2X	#008000
	7	(untitled)	4:2E, 3:1E	4:2X, 3:1X	#FFA500
	8	(untitled)	4:1E, 2:2E	4:1X, 2:2X	#00FFFF

Normal Paths and Flows

OD Matrix	Path	Description	From location	To location	Path items	Allocation type	Normal Calculated Flow (Veh/hr)
1	1		1	2	C/1, Dx/1	Normal	21
	2		1	3	C/1, Ax/1	Normal	323
	5		2	3	D/1, Ax/1	Normal	8
	6		2	4	D/1, Bx/1	Normal	0
	7		2	1	D/1, Cx/1	Normal	13
	8		3	2	A/1, Dx/1	Normal	12
	9		3	4	A/1, Bx/1	Normal	32
	10		3	1	A/1, Cx/1	Normal	403
	11		4	2	B/1, Dx/1	Normal	0
	12		4	3	B/1, Ax/1	Normal	43
	13		4	1	B/1, Cx/1	Normal	11
	21		1	4	C/2, Bx/1	Normal	8

Pedestrian Paths and Flows

OD Matrix	Path	Description	From location	To location	Path items	Allocation type	Pedestrian calculated flow (Ped/hr)
1	17		8	7	4:1E, 4:2X	Normal	30
	18		8	6	2:2E, 2:1X	Normal	30
	22		5	7	3:2E, 3:1X	Normal	30
	23		5	6	1:1E, 1:2X	Normal	30
	34		6	8	2:1E, 2:2X	Normal	30
	35		6	5	1:2E, 1:1X	Normal	30
	41		7	8	4:2E, 4:1X	Normal	30
	42		7	5	3:1E, 3:2X	Normal	30

Signal Timings

Network Default: 120s cycle time; 120 steps

Controller Stream 1

Controller Stream	Name	Description	Use sequence	Cycle time source	Cycle time (s)
1	(untitled)		1	NetworkDefault	120

Controller Stream 1 - Properties

Controller Stream	Manufacturer name	Type	Model number	(Telephone) Line Number	Site number	Grid reference	Gaining delay type
1	Unspecified						Relative

Controller Stream 1 - Optimisation

Controller Stream	Allow offset optimisation	Allow green split optimisation	Optimisation level	Auto redistribute	Enable stage constraint
1	✓	✓	Offsets And Green Splits	✓	

Phases

Controller Stream	Phase	Name	Minimum green (s)	Maximum green (s)	Relative start displacement (s)	Relative end displacement (s)	Type	Blackout Time (s)
1	A	(untitled)	0	300	0	0	Traffic	
	B	(untitled)	0	300	0	0	Traffic	
	C	(untitled)	0	300	0	0	Traffic	
	D	(untitled)	0	5	0	0	Traffic	
	E	(untitled)	5	5	0	0	Pedestrian	0

Library Stages

Controller Stream	Library Stage	Phases in stage	User stage minimum (s)
1	1	A	1
	2	B	1
	3	C	1
	4	D	1
	5	E	1

Stage Sequences

Controller Stream	Sequence	Name	Multiple cycling	Stage IDs	Stage ends
1	1	(untitled)	Single	1, 2, 3, 4, 5	21, 73, 84, 92, 102

Intergreen Matrix for Controller Stream 1

		To				
		A	B	C	D	E
From	A		5	5	5	5
	B	5		5	5	5
	C	5	5		5	5
	D	5	5	5		5
	E	5	5	5	5	

Banned Stage transitions for Controller Stream 1

		To				
		1	2	3	4	5
From	1					
	2					
	3					
	4					
	5					

Interstage Matrix for Controller Stream 1

		To				
		1	2	3	4	5
From	1	0	5	5	5	5
	2	5	0	5	5	5
	3	5	5	0	5	5
	4	5	5	5	0	5
	5	5	5	5	5	0

Resultant Stages

Controller Stream	Resultant Stage	Is base stage	Library Stage ID	Phases in this stage	Stage start (s)	Stage end (s)	Stage duration (s)	User stage minimum (s)	Stage minimum (s)
1	1	✓	1	A	107	21	34	1	1
	2	✓	2	B	26	73	47	1	1
	3	✓	3	C	78	84	6	1	1
	4	✓	4	D	89	92	3	1	1
	5	✓	5	E	97	102	5	1	5

Resultant Phase Green Periods

Controller Stream	Phase	Green period	Is base green period	Start time (s)	End time (s)	Duration (s)
1	A	1	✓	107	21	34
	B	1	✓	26	73	47
	C	1	✓	78	84	6
	D	1	✓	89	92	3
	E	1	✓	97	102	5

Traffic Stream Green Times

Arm	Traffic Stream	Traffic Node	Controller Stream	Phase	Green Period 1		
					Start	End	Duration
A	1	1	1	B	26	73	47
B	1	1	1	C	78	84	6
C	1	1	1	A	107	21	34
C	2	1	1	A	107	21	34
D	1	1	1	D	89	92	3

Phase Timings Diagram for Controller Stream 1

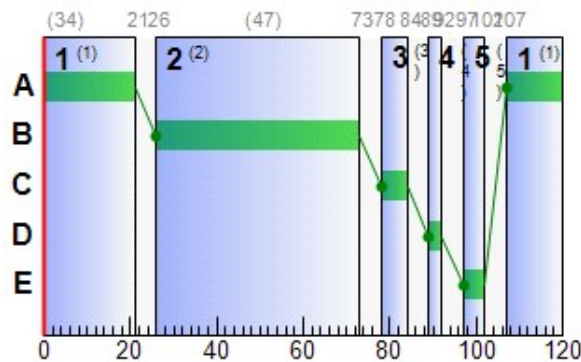

Stage Sequence Diagram for Controller Stream 1

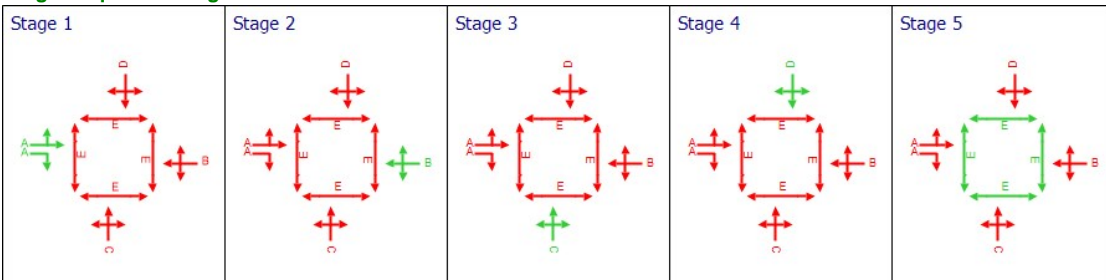

Resultant penalties

Time Segment	Controller stream	Phase min max penalty (£ per hr)	Intergreen broken penalty (£ per hr)	Stage constraint broken penalty (£ per hr)	Cost of controller stream penalties (£ per hr)
17:00-18:00	1	0.00	0.00	0.00	0.00

Traffic Stream Results

Traffic Stream Results: Vehicle summary

Time Segment	Arm	Traffic Stream	Degree of saturation (%)	Practical reserve capacity (%)	Calculated flow entering (Veh/hr)	Calculated sat flow (Veh/hr)	Actual green (s per cycle)	Mean Delay per Veh (s)	Mean max queue (Veh)	Utilised storage (%)	Weighted cost of delay (£ per hr)	Weighted cost of stops (£ per hr)	Performance Index (£ per hr)
17:00-18:00	A	1	62	61	447	1800	47	32.80	12.30	141.45	57.83	4.56	62.38
	Ax	1	0	Unrestricted	374	Unrestricted	120	0.00	0.00	0.00	0.00	0.00	0.00
	B	1	51	94	54	1800	6	72.50	2.00	23.05	15.44	0.74	16.19
	Bx	1	0	Unrestricted	40	Unrestricted	120	0.00	0.00	0.00	0.00	0.00	0.00
	C	1	66	53	344	1800	34	43.64	10.65	122.44	59.22	3.93	63.15
		2	2	6463	8	1800	34	30.51	0.19	2.17	0.96	0.07	1.03
	Cx	1	0	Unrestricted	427	Unrestricted	120	0.00	0.00	0.00	0.00	0.00	0.00
	D	1	35	186	21	1800	3	72.61	0.77	8.91	6.01	0.29	6.30
Dx	1	0	Unrestricted	33	Unrestricted	120	0.00	0.00	0.00	0.00	0.00	0.00	

Traffic Stream Results: Flows and signals

Time Segment	Arm	Traffic Stream	Calculated flow entering (Veh/hr)	Calculated flow out (Veh/hr)	Flow discrepancy (Veh/hr)	Adjusted flow warning	Calculated sat flow (Veh/hr)	Calculated capacity (Veh/hr)	Degree of saturation (%)	DOS Threshold exceeded	Practical reserve capacity (%)	Mean modulus of error	Actual green (s per cycle)
17:00-18:00	A	1	447	447	0		1800	720	62		61	0.00	47
	Ax	1	374	374	0		Unrestricted	Unrestricted	0		Unrestricted	1.11	120
	B	1	54	54	0		1800	105	51		94	0.00	6
	Bx	1	40	40	0		Unrestricted	Unrestricted	0		Unrestricted	0.88	120
	C	1	344	344	0		1800	525	66		53	0.00	34
		2	8	8	0		1800	525	2		6463	0.00	34
	Cx	1	427	427	0		Unrestricted	Unrestricted	0		Unrestricted	1.02	120
	D	1	21	21	0		1800	60	35		186	0.00	3
Dx	1	33	33	0		Unrestricted	Unrestricted	0		Unrestricted	0.77	120	

Traffic Stream Results: Stops and delays

Time Segment	Arm	Traffic Stream	Mean Cruise Time per Veh (s)	Mean Delay per Veh (s)	Uniform delay (Veh-hr/hr)	Random plus oversat delay (Veh-hr/hr)	Weighted cost of delay (£ per hr)	Mean stops per Veh (%)	Uniform stops (Stops per hr)	Random stops (Stops per hr)	Weighted cost of stops (£ per hr)
17:00-18:00	A	1	6.00	32.80	3.57	0.50	57.83	81.28	348.31	15.00	4.56
	Ax	1	16.50	0.00	0.00	0.00	0.00	0.00	0.00	0.00	0.00
	B	1	6.00	72.50	0.82	0.26	15.44	109.83	51.67	7.64	0.74
	Bx	1	16.59	0.00	0.00	0.00	0.00	0.00	0.00	0.00	0.00
	C	1	6.00	43.64	3.56	0.61	59.22	91.05	295.02	18.18	3.93
		2	6.00	30.51	0.07	0.00	0.96	69.89	5.59	0.00	0.07
	Cx	1	16.80	0.00	0.00	0.00	0.00	0.00	0.00	0.00	0.00
	D	1	6.00	72.61	0.33	0.09	6.01	109.25	20.27	2.68	0.29
Dx	1	16.45	0.00	0.00	0.00	0.00	0.00	0.00	0.00	0.00	

Traffic Stream Results: Queues and blocking

Time Segment	Arm	Traffic Stream	Initial queue (Veh)	Mean max queue (Veh)	Max queue storage (Veh)	Utilised storage (%)	Average storage excess queue (Veh)	Average limit excess queue (Veh)	Excess queue penalty (£ per hr)	Wasted time starvation (s (per cycle))	Wasted time blocking back (s (per cycle))	Wasted time total (s (per cycle))	Estimated blocking	
17:00-18:00	A	1	0.00	12.30	8.70	141.45	0.45	0.00	0.00	0.00	0.00	0.00		
	Ax	1	0.00	0.00	23.92	0.00	0.00	0.00	0.00	56.00	0.00	56.00		
	B	1	0.00	2.00	8.70	23.05	0.00	0.00	0.00	3.00	0.00	3.00		
	Bx	1	0.00	0.00	24.05	0.00	0.00	0.00	0.00	88.00	0.00	88.00		
	C	1	0.00	10.65	8.70	122.44	0.17	0.00	0.00	0.00	0.00	0.00	0.00	
		2	0.00	0.19	8.70	2.17	0.00	0.00	0.00	0.00	34.00	0.00	34.00	
	Cx	1	0.00	0.00	24.35	0.00	0.00	0.00	0.00	47.00	0.00	47.00		
	D	1	0.00	0.77	8.70	8.91	0.00	0.00	0.00	0.00	2.00	0.00	2.00	
Dx	1	0.00	0.00	23.84	0.00	0.00	0.00	0.00	0.00	100.00	0.00	100.00		

Pedestrian Crossing Results

Pedestrian Crossings: Pedestrian summary

Time Segment	Crossing	Side	Degree of saturation (%)	Calculated Flow Entering (Ped/hr)	Calculated sat flow (Ped/hr)	Actual green (s (per cycle))	Mean Delay Per Ped (s)	Mean max queue (Ped)	Weighted cost of delay (£ per hr)	Performance Index (£ per hr)
17:00-18:00	(ALL)	(ALL)	7	30	11000	5	55.58	0.96	6.58	6.58

Pedestrian Crossings: Flows and signals

Time Segment	Crossing	Side	Calculated flow entering (Ped/hr)	Calculated flow out (Ped/hr)	Flow discrepancy (Ped/hr)	Adjusted flow warning	Calculated sat flow (Ped/hr)	Calculated capacity (Ped/hr)	Degree of saturation (%)	DOS Threshold exceeded	Practical reserve capacity (%)	Mean modulus of error	Actual green (s (per cycle))
17:00-18:00	(ALL)	(ALL)	30	30	0		11000	458	7		1428	0.00	5

Pedestrian Crossings: Stops and delays

Time Segment	Crossing	Side	Mean Cruise Time per Ped (s)	Mean Delay per Ped (s)	Uniform delay (Ped-hr/hr)	Random plus oversat delay (Ped-hr/hr)	Weighted cost of delay (£ per hr)
17:00-18:00	1	1	5.67	55.58	0.46	0.00	6.58
		2	5.67	55.58	0.46	0.00	6.58
	2	1	6.33	55.58	0.46	0.00	6.58
		2	6.33	55.58	0.46	0.00	6.58
	3	1	6.33	55.58	0.46	0.00	6.58
		2	6.33	55.58	0.46	0.00	6.58
	4	1	5.67	55.58	0.46	0.00	6.58
		2	5.67	55.58	0.46	0.00	6.58

Pedestrian Crossings: Queues and blocking

Time Segment	Crossing	Side	Mean max queue (Ped)	Max queue storage (Ped)	Utilised storage (%)	Average storage excess queue (Ped)	Average limit excess queue (Ped)	Excess queue penalty (£ per hr)
17:00-18:00	(ALL)	(ALL)	0.96	10.00	9.58	0.00	0.00	0.00

Network Results

Network Results: Flows and signals

Time Segment	Calculated flow entering (Veh/hr)	Calculated flow out (Veh/hr)	Flow discrepancy (Veh/hr)	Adjusted flow warning	Degree of saturation (%)	DOS Threshold exceeded	Practical reserve capacity (%)	Actual green (s (per cycle))
17:00-18:00	1988	1988	0		66		53	644

Network Results: Stops and delays

Time Segment	Mean Cruise Time per Veh (s)	Mean Delay per Veh (s)	Uniform delay (Veh-hr/hr)	Random plus oversat delay (Veh-hr/hr)	Weighted cost of delay (£ per hr)	Mean stops per Veh (%)	Uniform stops (Stops per hr)	Random stops (Stops per hr)	Weighted cost of stops (£ per hr)
17:00-18:00	10.68	24.50	12.05	1.47	192.09	38.45	720.86	43.50	9.58

Network Results: Queues and blocking

Time Segment	Utilised storage (%)	Excess queue penalty (£ per hr)	Wasted time starvation (s per cycle))	Wasted time blocking back (s per cycle))	Wasted time total (s per cycle))
17:00-18:00	141.45	0.00	330.00	0.00	330.00

Final Prediction Table

Traffic Stream Results

Arm	Traffic Stream	Name	Traffic node	SIGNALS		FLOWS		PERFORMANCE				PER PCU			QUEUES
				Controller stream	Phase	Calculated flow entering (Veh/hr)	Calculated sat flow (Veh/hr)	Actual green (s per cycle)	Wasted time total (s per cycle)	Degree of saturation (%)	Practical reserve capacity (%)	JourneyTime (s)	Mean Delay per Veh (s)	Mean stops per Veh (%)	Mean max queue (Veh)
A	1	(untitled)	1	1	B	447 <	1800	47	0.00	62	61	38.80	32.80	81.28	12.30 +
Ax	1	(untitled)				374	Unrestricted	120	56.00	0	Unrestricted	16.50	0.00	0.00	0.00
B	1	(untitled)	1	1	C	54	1800	6	3.00	51	94	78.50	72.50	109.83	2.00
Bx	1	(untitled)				40	Unrestricted	120	88.00	0	Unrestricted	16.59	0.00	0.00	0.00
C	1	(untitled)	1	1	A	344 <	1800	34	0.00	66	53	49.64	43.64	91.05	10.65 +
	2	(untitled)	1	1	A	8	1800	34	34.00	2	6463	36.51	30.51	69.89	0.19
Cx	1	(untitled)				427	Unrestricted	120	47.00	0	Unrestricted	16.80	0.00	0.00	0.00
D	1	(untitled)	1	1	D	21	1800	3	2.00	35	186	78.61	72.61	109.25	0.77
Dx	1	(untitled)				33	Unrestricted	120	100.00	0	Unrestricted	16.45	0.00	0.00	0.00

Pedestrian Crossing Results

Pedestrian	Side	Name	Traffic node	SIGNALS		FLOWS		PERFORMANCE			PER PED		QUEUES	WEIGHTS	PEN
				Controller stream	Phase	Calculated Flow Entering (Ped/hr)	Calculated sat flow (Ped/hr)	Actual green (s per cycle)	Degree of saturation (%)	Practical reserve capacity (%)	JourneyTime (s)	Mean Delay per Ped (s)	Mean max queue (Ped)	Delay weighting (%)	Co tra pen (£ p
1	1	(untitled)	1	1	E	30	11000	5	7	1428	61.25	55.58	0.96	100	0
	2	(untitled)	1	1	E	30	11000	5	7	1428	61.25	55.58	0.96	100	0
2	1	(untitled)	1	1	E	30	11000	5	7	1428	61.92	55.58	0.96	100	0
	2	(untitled)	1	1	E	30	11000	5	7	1428	61.92	55.58	0.96	100	0
3	1	(untitled)	1	1	E	30	11000	5	7	1428	61.92	55.58	0.96	100	0
	2	(untitled)	1	1	E	30	11000	5	7	1428	61.92	55.58	0.96	100	0
4	1	(untitled)	1	1	E	30	11000	5	7	1428	61.25	55.58	0.96	100	0
	2	(untitled)	1	1	E	30	11000	5	7	1428	61.25	55.58	0.96	100	0

Network Results

	Distance travelled (PCU-km/hr)	Time spent (PCU-hr/hr)	Mean journey speed (kph)	Uniform delay (Veh-hr/hr)	Random plus oversat delay (Veh-hr/hr)	Weighted cost of delay (£ per hr)	Weighted cost of stops (£ per hr)	Excess queue penalty (£ per hr)	Performance Index (£ per hr)
Normal traffic	164.97	15.32	10.77	8.35	1.47	139.47	9.58	0.00	149.05
Bus	0.00	0.00	0.00	0.00	0.00	0.00	0.00	0.00	0.00
Tram	0.00	0.00	0.00	0.00	0.00	0.00	0.00	0.00	0.00
Pedestrians	2.04	4.11	0.50	3.71	0.00	52.62	0.00	0.00	52.62
TOTAL	167.01	19.43	8.60	12.05	1.47	192.09	9.58	0.00	201.67

- | < = adjusted flow warning (upstream links/traffic streams are over-saturated)
- | * = Traffic Stream - Normal, Bus or Tram Stop or Delay weighting has been set to a value other than 100%
- | ^ = Traffic Stream - Normal, Bus or Tram Stop or Delay Path weighting has been set to a value other than 100%
- | + = average link/traffic stream excess queue is greater than 0
- | **P.I. = PERFORMANCE INDEX**

A3 - DO NOTHING 2039 D3 - DO NOTHING 2039*

Summary

Data Errors and Warnings

No errors or warnings

Run Summary

Analysis set used	Run start time	Run finish time	Modelling start time (HH:mm)	Network Cycle Time (s)	Performance Index (£ per hr)	Total network delay (Veh-hr/hr)	Highest DOS (%)	Item with highest DOS	Number of oversaturated items	Percentage of oversaturated items (%)	Item with worst signalised PRC	Item with worst unsignalised PRC	Item with worst over PR
3	19/08/2020 12:13:13	19/08/2020 12:13:14	17:00	120	215.60	14.45	69.71	C/1	0	0	C/1	Dx/1	C/

Analysis Set Details

Name	Description	Demand set	Include in report	Locked
DO NOTHING 2039	PM	D3	✓	

Demand Set Details

Name	Description	Composite	Demand sets	Start time (HH:mm)	Locked
DO NOTHING 2039	PM			17:00	

Arms and Traffic Streams

Arms

Arm	Name	Description	Traffic node
A	(untitled)		1
Ax	(untitled)		
B	(untitled)		1
Bx	(untitled)		
C	(untitled)		1
Cx	(untitled)		
D	(untitled)		1
Dx	(untitled)		

Traffic Streams

Arm	Traffic Stream	Name	Description	Auto length	Length (m)	Has Saturation Flow	Saturation flow source	Saturation flow (PCU/hr)	Is signal controlled	Is give way	Traffic type	Allow Nearside Turn On Red
A	1	(untitled)		✓	50.00	✓	Sum of lanes	1800	✓		Normal	
Ax	1	(untitled)		✓	137.53						Normal	
B	1	(untitled)		✓	50.00	✓	Sum of lanes	1800	✓		Normal	
Bx	1	(untitled)		✓	138.27						Normal	
C	1	(untitled)		✓	50.00	✓	Sum of lanes	1800	✓		Normal	
	2	(untitled)		✓	50.00	✓	Sum of lanes	1800	✓		Normal	
Cx	1	(untitled)		✓	140.00						Normal	
D	1	(untitled)		✓	50.00	✓	Sum of lanes	1800	✓		Normal	
Dx	1	(untitled)		✓	137.05						Normal	

Lanes

Arm	Traffic Stream	Lane	Name	Description	Use RR67	Saturation flow (PCU/hr)
A	1	1	(untitled)			1800
Ax	1	1	(untitled)			
B	1	1	(untitled)			1800
Bx	1	1	(untitled)			
C	1	1	(untitled)			1800
	2	1	(untitled)			1800
Cx	1	1	(untitled)			
D	1	1	(untitled)			1800
Dx	1	1	(untitled)			

Modelling

Arm	Traffic Stream	Traffic model	Stop weighting multiplier (%)	Delay weighting multiplier (%)	Assignment Cost Weighting (%)	Exclude from results calculation	Max queue storage (PCU)	Has queue limit	Has degree of saturation limit
(ALL)	(ALL)	NetworkDefault	100	100	100		0.00		

Modelling - Advanced

Arm	Traffic Stream	Initial queue (PCU)	Type of Vehicle-in-Service	Vehicle-in-Service	Type of random parameter	Random parameter	Auto cycle time	Cycle time
(ALL)	(ALL)	0.00	NetworkDefault	Not-Included	NetworkDefault	0.50	✓	120

Normal traffic - Modelling

Arm	Traffic Stream	Stop weighting (%)	Delay weighting (%)
(ALL)	(ALL)	100	100

Normal traffic - Advanced

Arm	Traffic Stream	Dispersion type for Normal Traffic
(ALL)	(ALL)	NetworkDefault

Flows

Arm	Traffic Stream	Total Flow (Veh/hr)	Normal Flow (Veh/hr)
A	1	477	477
Ax	1	396	396
B	1	54	54
Bx	1	40	40
C	1	366	366
	2	8	8
Cx	1	457	457
D	1	21	21
Dx	1	33	33

Signals

Arm	Traffic Stream	Controller stream	Phase	Second phase enabled
A	1	1	B	
B	1	1	C	
C	1	1	A	
	2	1	A	
D	1	1	D	

Pedestrian Crossings

Pedestrian Crossings

Crossing	Name	Description	Traffic node	Allow walk on red	Crossing type	Length (m)	Cruise time (seconds)	Cruise speed (kph)
1	(untitled)		1		Farside	7.00	4.67	5.40
2	(untitled)		1		Farside	8.00	5.33	5.40
3	(untitled)		1		Farside	8.00	5.33	5.40
4	(untitled)		1		Farside	7.00	4.67	5.40

Pedestrian Crossings - Signals

Crossing	Controller stream	Phase	Second phase enabled
(ALL)	1	E	

Pedestrian Crossings - Sides

Crossing	Side	Saturation flow (Ped/hr)
(ALL)	(ALL)	11000

Pedestrian Crossings - Modelling

Crossing	Side	Delay weighting (%)	Assignment Cost Weighting (%)	Exclude from results calculation	Max queue storage (Ped)	Has queue limit	Has degree of saturation limit
(ALL)	(ALL)	100	100		0.00		

Local OD Matrix - Local Matrix: 1

Local Matrix Options

OD Matrix	Name	Use for point to point table	Auto calculate	Allocation mode	Allow paths past exit locations	Allow looped paths on arms	Allow looped paths on traffic nodes	Copy flows	Matrix to copy flows from	Limit paths by length	Path length limit multiplier	Limit paths by number	Path number limit
1	(untitled)	✓	✓	Path Equalisation	✓		✓			✓	1.25		

Normal Input Flows (Veh/hr)

		To							
		1	2	3	4	5	6	7	8
From	1	0	21	345	8	0	0	0	0
	2	13	0	8	0	0	0	0	0
	3	433	12	0	32	0	0	0	0
	4	11	0	43	0	0	0	0	0
	5	0	0	0	0	0	0	0	0
	6	0	0	0	0	0	0	0	0
	7	0	0	0	0	0	0	0	0
	8	0	0	0	0	0	0	0	0

Bus Input Flows not shown as they are blank.

Tram Input Flows not shown as they are blank.

Pedestrian Input Flows (Veh/hr)

From	To							
	1	2	3	4	5	6	7	8
1	0	0	0	0	0	0	0	0
2	0	0	0	0	0	0	0	0
3	0	0	0	0	0	0	0	0
4	0	0	0	0	0	0	0	0
5	0	0	0	0	0	30	30	0
6	0	0	0	0	30	0	0	30
7	0	0	0	0	30	0	0	30
8	0	0	0	0	0	30	30	0

Locations

OD Matrix	Location	Name	Entries	Exits	Colour
1	1	(untitled)	C/1, C/2	Cx/1	#0000FF
	2	(untitled)	D/1	Dx/1	#FF0000
	3	(untitled)	A/1	Ax/1	#00FF00
	4	(untitled)	B/1	Bx/1	#FFFF00
	5	(untitled)	3:2E, 1:1E	3:2X, 1:1X	#FF00FF
	6	(untitled)	2:1E, 1:2E	2:1X, 1:2X	#008000
	7	(untitled)	4:2E, 3:1E	4:2X, 3:1X	#FFA500
	8	(untitled)	4:1E, 2:2E	4:1X, 2:2X	#00FFFF

Normal Paths and Flows

OD Matrix	Path	Description	From location	To location	Path items	Allocation type	Normal Calculated Flow (Veh/hr)
1	1		1	2	C/1, Dx/1	Normal	21
	2		1	3	C/1, Ax/1	Normal	345
	5		2	3	D/1, Ax/1	Normal	8
	6		2	4	D/1, Bx/1	Normal	0
	7		2	1	D/1, Cx/1	Normal	13
	8		3	2	A/1, Dx/1	Normal	12
	9		3	4	A/1, Bx/1	Normal	32
	10		3	1	A/1, Cx/1	Normal	433
	11		4	2	B/1, Dx/1	Normal	0
	12		4	3	B/1, Ax/1	Normal	43
	13		4	1	B/1, Cx/1	Normal	11
	21		1	4	C/2, Bx/1	Normal	8

Pedestrian Paths and Flows

OD Matrix	Path	Description	From location	To location	Path items	Allocation type	Pedestrian calculated flow (Ped/hr)
1	17		8	7	4:1E, 4:2X	Normal	30
	18		8	6	2:2E, 2:1X	Normal	30
	22		5	7	3:2E, 3:1X	Normal	30
	23		5	6	1:1E, 1:2X	Normal	30
	34		6	8	2:1E, 2:2X	Normal	30
	35		6	5	1:2E, 1:1X	Normal	30
	41		7	8	4:2E, 4:1X	Normal	30
	42		7	5	3:1E, 3:2X	Normal	30

Signal Timings

Network Default: 120s cycle time; 120 steps

Controller Stream 1

Controller Stream	Name	Description	Use sequence	Cycle time source	Cycle time (s)
1	(untitled)		1	NetworkDefault	120

Controller Stream 1 - Properties

Controller Stream	Manufacturer name	Type	Model number	(Telephone) Line Number	Site number	Grid reference	Gaining delay type
1	Unspecified						Relative

Controller Stream 1 - Optimisation

Controller Stream	Allow offset optimisation	Allow green split optimisation	Optimisation level	Auto redistribute	Enable stage constraint
1	✓	✓	Offsets And Green Splits	✓	

Phases

Controller Stream	Phase	Name	Minimum green (s)	Maximum green (s)	Relative start displacement (s)	Relative end displacement (s)	Type	Blackout Time (s)
1	A	(untitled)	0	300	0	0	Traffic	
	B	(untitled)	0	300	0	0	Traffic	
	C	(untitled)	0	300	0	0	Traffic	
	D	(untitled)	0	5	0	0	Traffic	
	E	(untitled)	5	5	0	0	Pedestrian	0

Library Stages

Controller Stream	Library Stage	Phases in stage	User stage minimum (s)
1	1	A	1
	2	B	1
	3	C	1
	4	D	1
	5	E	1

Stage Sequences

Controller Stream	Sequence	Name	Multiple cycling	Stage IDs	Stage ends
1	1	(untitled)	Single	1, 2, 3, 4, 5	21, 73, 84, 92, 102

Intergreen Matrix for Controller Stream 1

		To				
		A	B	C	D	E
From	A		5	5	5	5
	B	5		5	5	5
	C	5	5		5	5
	D	5	5	5		5
	E	5	5	5	5	

Banned Stage transitions for Controller Stream 1

		To				
		1	2	3	4	5
From	1					
	2					
	3					
	4					
	5					

Interstage Matrix for Controller Stream 1

		To				
		1	2	3	4	5
From	1	0	5	5	5	5
	2	5	0	5	5	5
	3	5	5	0	5	5
	4	5	5	5	0	5
	5	5	5	5	5	0

Resultant Stages

Controller Stream	Resultant Stage	Is base stage	Library Stage ID	Phases in this stage	Stage start (s)	Stage end (s)	Stage duration (s)	User stage minimum (s)	Stage minimum (s)
1	1	✓	1	A	107	21	34	1	1
	2	✓	2	B	26	73	47	1	1
	3	✓	3	C	78	84	6	1	1
	4	✓	4	D	89	92	3	1	1
	5	✓	5	E	97	102	5	1	5

Resultant Phase Green Periods

Controller Stream	Phase	Green period	Is base green period	Start time (s)	End time (s)	Duration (s)
1	A	1	✓	107	21	34
	B	1	✓	26	73	47
	C	1	✓	78	84	6
	D	1	✓	89	92	3
	E	1	✓	97	102	5

Traffic Stream Green Times

Arm	Traffic Stream	Traffic Node	Controller Stream	Phase	Green Period 1		
					Start	End	Duration
A	1	1	1	B	26	73	47
B	1	1	1	C	78	84	6
C	1	1	1	A	107	21	34
C	2	1	1	A	107	21	34
D	1	1	1	D	89	92	3

Phase Timings Diagram for Controller Stream 1

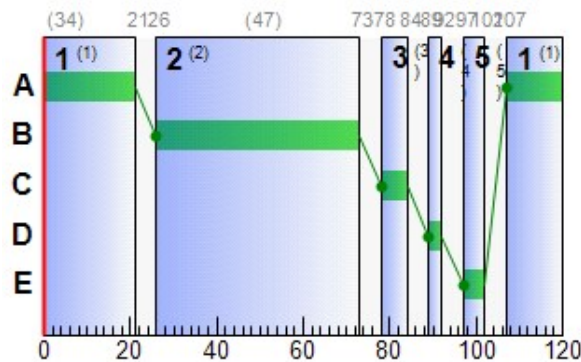

Stage Sequence Diagram for Controller Stream 1

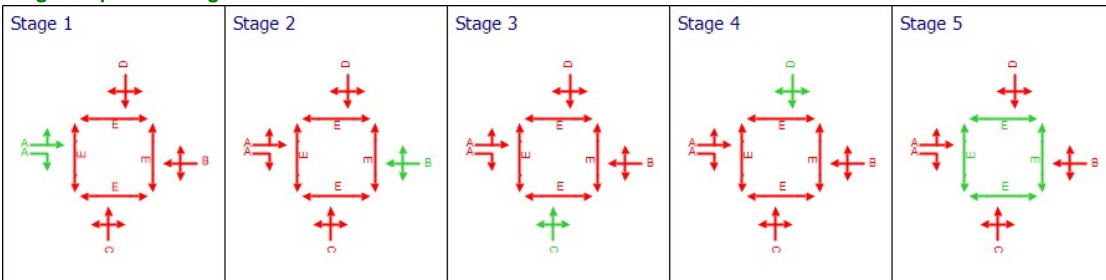

Resultant penalties

Time Segment	Controller stream	Phase min max penalty (£ per hr)	Intergreen broken penalty (£ per hr)	Stage constraint broken penalty (£ per hr)	Cost of controller stream penalties (£ per hr)
17:00-18:00	1	0.00	0.00	0.00	0.00

Traffic Stream Results

Traffic Stream Results: Vehicle summary

Time Segment	Arm	Traffic Stream	Degree of saturation (%)	Practical reserve capacity (%)	Calculated flow entering (Veh/hr)	Calculated sat flow (Veh/hr)	Actual green (s per cycle)	Mean Delay per Veh (s)	Mean max queue (Veh)	Utilised storage (%)	Weighted cost of delay (£ per hr)	Weighted cost of stops (£ per hr)	Performance Index (£ per hr)
17:00-18:00	A	1	66	51	477	1800	47	34.24	13.50	155.20	64.43	5.00	69.43
	Ax	1	0	Unrestricted	396	Unrestricted	120	0.00	0.00	0.00	0.00	0.00	0.00
	B	1	51	94	54	1800	6	72.50	2.00	23.05	15.44	0.74	16.19
	Bx	1	0	Unrestricted	40	Unrestricted	120	0.00	0.00	0.00	0.00	0.00	0.00
	C	1	70	43	366	1800	34	45.54	11.56	132.99	65.74	4.29	70.03
		2	2	6463	8	1800	34	30.51	0.19	2.17	0.96	0.07	1.03
	Cx	1	0	Unrestricted	457	Unrestricted	120	0.00	0.00	0.00	0.00	0.00	0.00
	D	1	35	186	21	1800	3	72.61	0.77	8.91	6.01	0.29	6.30
Dx	1	0	Unrestricted	33	Unrestricted	120	0.00	0.00	0.00	0.00	0.00	0.00	

Traffic Stream Results: Flows and signals

Time Segment	Arm	Traffic Stream	Calculated flow entering (Veh/hr)	Calculated flow out (Veh/hr)	Flow discrepancy (Veh/hr)	Adjusted flow warning	Calculated sat flow (Veh/hr)	Calculated capacity (Veh/hr)	Degree of saturation (%)	DOS Threshold exceeded	Practical reserve capacity (%)	Mean modulus of error	Actual green (s per cycle)
17:00-18:00	A	1	477	477	0		1800	720	66		51	0.00	47
	Ax	1	396	396	0		Unrestricted	Unrestricted	0		Unrestricted	1.11	120
	B	1	54	54	0		1800	105	51		94	0.00	6
	Bx	1	40	40	0		Unrestricted	Unrestricted	0		Unrestricted	0.87	120
	C	1	366	366	0		1800	525	70		43	0.00	34
		2	8	8	0		1800	525	2		6463	0.00	34
	Cx	1	457	457	0		Unrestricted	Unrestricted	0		Unrestricted	1.02	120
	D	1	21	21	0		1800	60	35		186	0.00	3
Dx	1	33	33	0		Unrestricted	Unrestricted	0		Unrestricted	0.75	120	

Traffic Stream Results: Stops and delays

Time Segment	Arm	Traffic Stream	Mean Cruise Time per Veh (s)	Mean Delay per Veh (s)	Uniform delay (Veh-hr/hr)	Random plus oversat delay (Veh-hr/hr)	Weighted cost of delay (£ per hr)	Mean stops per Veh (%)	Uniform stops (Stops per hr)	Random stops (Stops per hr)	Weighted cost of stops (£ per hr)
17:00-18:00	A	1	6.00	34.24	3.89	0.64	64.43	83.62	379.75	19.11	5.00
	Ax	1	16.50	0.00	0.00	0.00	0.00	0.00	0.00	0.00	0.00
	B	1	6.00	72.50	0.82	0.26	15.44	109.83	51.67	7.64	0.74
	Bx	1	16.59	0.00	0.00	0.00	0.00	0.00	0.00	0.00	0.00
	C	1	6.00	45.54	3.84	0.79	65.74	93.50	318.96	23.25	4.29
		2	6.00	30.51	0.07	0.00	0.96	69.89	5.59	0.00	0.07
	Cx	1	16.80	0.00	0.00	0.00	0.00	0.00	0.00	0.00	0.00
	D	1	6.00	72.61	0.33	0.09	6.01	109.25	20.27	2.68	0.29
Dx	1	16.45	0.00	0.00	0.00	0.00	0.00	0.00	0.00	0.00	

Traffic Stream Results: Queues and blocking

Time Segment	Arm	Traffic Stream	Initial queue (Veh)	Mean max queue (Veh)	Max queue storage (Veh)	Utilised storage (%)	Average storage excess queue (Veh)	Average limit excess queue (Veh)	Excess queue penalty (£ per hr)	Wasted time starvation (s (per cycle))	Wasted time blocking back (s (per cycle))	Wasted time total (s (per cycle))	Estimated blocking	
17:00-18:00	A	1	0.00	13.50	8.70	155.20	0.74	0.00	0.00	0.00	0.00	0.00		
	Ax	1	0.00	0.00	23.92	0.00	0.00	0.00	0.00	55.00	0.00	55.00		
	B	1	0.00	2.00	8.70	23.05	0.00	0.00	0.00	3.00	0.00	3.00		
	Bx	1	0.00	0.00	24.05	0.00	0.00	0.00	0.00	87.00	0.00	87.00		
	C	1	0.00	11.56	8.70	132.99	0.35	0.00	0.00	0.00	0.00	0.00	0.00	
		2	0.00	0.19	8.70	2.17	0.00	0.00	0.00	0.00	34.00	0.00	34.00	
	Cx	1	0.00	0.00	24.35	0.00	0.00	0.00	0.00	47.00	0.00	47.00		
	D	1	0.00	0.77	8.70	8.91	0.00	0.00	0.00	0.00	2.00	0.00	2.00	
Dx	1	0.00	0.00	23.84	0.00	0.00	0.00	0.00	0.00	99.00	0.00	99.00		

Pedestrian Crossing Results

Pedestrian Crossings: Pedestrian summary

Time Segment	Crossing	Side	Degree of saturation (%)	Calculated Flow Entering (Ped/hr)	Calculated sat flow (Ped/hr)	Actual green (s (per cycle))	Mean Delay Per Ped (s)	Mean max queue (Ped)	Weighted cost of delay (£ per hr)	Performance Index (£ per hr)
17:00-18:00	(ALL)	(ALL)	7	30	11000	5	55.58	0.96	6.58	6.58

Pedestrian Crossings: Flows and signals

Time Segment	Crossing	Side	Calculated flow entering (Ped/hr)	Calculated flow out (Ped/hr)	Flow discrepancy (Ped/hr)	Adjusted flow warning	Calculated sat flow (Ped/hr)	Calculated capacity (Ped/hr)	Degree of saturation (%)	DOS Threshold exceeded	Practical reserve capacity (%)	Mean modulus of error	Actual green (s (per cycle))
17:00-18:00	(ALL)	(ALL)	30	30	0		11000	458	7		1428	0.00	5

Pedestrian Crossings: Stops and delays

Time Segment	Crossing	Side	Mean Cruise Time per Ped (s)	Mean Delay per Ped (s)	Uniform delay (Ped-hr/hr)	Random plus oversat delay (Ped-hr/hr)	Weighted cost of delay (£ per hr)
17:00-18:00	1	1	5.67	55.58	0.46	0.00	6.58
		2	5.67	55.58	0.46	0.00	6.58
	2	1	6.33	55.58	0.46	0.00	6.58
		2	6.33	55.58	0.46	0.00	6.58
	3	1	6.33	55.58	0.46	0.00	6.58
		2	6.33	55.58	0.46	0.00	6.58
	4	1	5.67	55.58	0.46	0.00	6.58
		2	5.67	55.58	0.46	0.00	6.58

Pedestrian Crossings: Queues and blocking

Time Segment	Crossing	Side	Mean max queue (Ped)	Max queue storage (Ped)	Utilised storage (%)	Average storage excess queue (Ped)	Average limit excess queue (Ped)	Excess queue penalty (£ per hr)
17:00-18:00	(ALL)	(ALL)	0.96	10.00	9.58	0.00	0.00	0.00

Network Results

Network Results: Flows and signals

Time Segment	Calculated flow entering (Veh/hr)	Calculated flow out (Veh/hr)	Flow discrepancy (Veh/hr)	Adjusted flow warning	Degree of saturation (%)	DOS Threshold exceeded	Practical reserve capacity (%)	Actual green (s (per cycle))
17:00-18:00	2092	2092	0		70		43	644

Network Results: Stops and delays

Time Segment	Mean Cruise Time per Veh (s)	Mean Delay per Veh (s)	Uniform delay (Veh-hr/hr)	Random plus oversat delay (Veh-hr/hr)	Weighted cost of delay (£ per hr)	Mean stops per Veh (%)	Uniform stops (Stops per hr)	Random stops (Stops per hr)	Weighted cost of stops (£ per hr)
17:00-18:00	10.71	24.87	12.66	1.79	205.21	39.62	776.23	52.68	10.39

Network Results: Queues and blocking

Time Segment	Utilised storage (%)	Excess queue penalty (£ per hr)	Wasted time starvation (s per cycle)	Wasted time blocking back (s per cycle)	Wasted time total (s per cycle)
17:00-18:00	155.20	0.00	327.00	0.00	327.00

Final Prediction Table

Traffic Stream Results

Arm	Traffic Stream	Name	Traffic node	SIGNALS		FLOWS		PERFORMANCE				PER PCU			QUEUES
				Controller stream	Phase	Calculated flow entering (Veh/hr)	Calculated sat flow (Veh/hr)	Actual green (s per cycle)	Wasted time total (s per cycle)	Degree of saturation (%)	Practical reserve capacity (%)	JourneyTime (s)	Mean Delay per Veh (s)	Mean stops per Veh (%)	Mean max queue (Veh)
A	1	(untitled)	1	1	B	477 <	1800	47	0.00	66	51	40.24	34.24	83.62	13.50 +
Ax	1	(untitled)				396	Unrestricted	120	55.00	0	Unrestricted	16.50	0.00	0.00	0.00
B	1	(untitled)	1	1	C	54	1800	6	3.00	51	94	78.50	72.50	109.83	2.00
Bx	1	(untitled)				40	Unrestricted	120	87.00	0	Unrestricted	16.59	0.00	0.00	0.00
C	1	(untitled)	1	1	A	366 <	1800	34	0.00	70	43	51.54	45.54	93.50	11.56 +
	2	(untitled)	1	1	A	8	1800	34	34.00	2	6463	36.51	30.51	69.89	0.19
Cx	1	(untitled)				457	Unrestricted	120	47.00	0	Unrestricted	16.80	0.00	0.00	0.00
D	1	(untitled)	1	1	D	21	1800	3	2.00	35	186	78.61	72.61	109.25	0.77
Dx	1	(untitled)				33	Unrestricted	120	99.00	0	Unrestricted	16.45	0.00	0.00	0.00

Pedestrian Crossing Results

Pedestrian	Side	Name	Traffic node	SIGNALS		FLOWS		PERFORMANCE			PER PED		QUEUES	WEIGHTS	PEN
				Controller stream	Phase	Calculated Flow Entering (Ped/hr)	Calculated sat flow (Ped/hr)	Actual green (s per cycle)	Degree of saturation (%)	Practical reserve capacity (%)	JourneyTime (s)	Mean Delay per Ped (s)	Mean max queue (Ped)	Delay weighting (%)	Co tra pen (£ p)
1	1	(untitled)	1	1	E	30	11000	5	7	1428	61.25	55.58	0.96	100	0
	2	(untitled)	1	1	E	30	11000	5	7	1428	61.25	55.58	0.96	100	0
2	1	(untitled)	1	1	E	30	11000	5	7	1428	61.92	55.58	0.96	100	0
	2	(untitled)	1	1	E	30	11000	5	7	1428	61.92	55.58	0.96	100	0
3	1	(untitled)	1	1	E	30	11000	5	7	1428	61.92	55.58	0.96	100	0
	2	(untitled)	1	1	E	30	11000	5	7	1428	61.92	55.58	0.96	100	0
4	1	(untitled)	1	1	E	30	11000	5	7	1428	61.25	55.58	0.96	100	0
	2	(untitled)	1	1	E	30	11000	5	7	1428	61.25	55.58	0.96	100	0

Network Results

	Distance travelled (PCU-km/hr)	Time spent (PCU-hr/hr)	Mean journey speed (kph)	Uniform delay (Veh-hr/hr)	Random plus oversat delay (Veh-hr/hr)	Weighted cost of delay (£ per hr)	Weighted cost of stops (£ per hr)	Excess queue penalty (£ per hr)	Performance Index (£ per hr)
Normal traffic	174.80	16.57	10.55	8.96	1.79	152.59	10.39	0.00	162.98
Bus	0.00	0.00	0.00	0.00	0.00	0.00	0.00	0.00	0.00
Tram	0.00	0.00	0.00	0.00	0.00	0.00	0.00	0.00	0.00
Pedestrians	2.04	4.11	0.50	3.71	0.00	52.62	0.00	0.00	52.62
TOTAL	176.84	20.68	8.55	12.66	1.79	205.21	10.39	0.00	215.60

- | < = adjusted flow warning (upstream links/traffic streams are over-saturated)
- | * = Traffic Stream - Normal, Bus or Tram Stop or Delay weighting has been set to a value other than 100%
- | ^ = Traffic Stream - Normal, Bus or Tram Stop or Delay Path weighting has been set to a value other than 100%
- | + = average link/traffic stream excess queue is greater than 0
- | **P.I. = PERFORMANCE INDEX**

A4 - DO SOMETHING 2024 D4 - DO SOMETHING 2024*

Summary

Data Errors and Warnings

No errors or warnings

Run Summary

Analysis set used	Run start time	Run finish time	Modelling start time (HH:mm)	Network Cycle Time (s)	Performance Index (£ per hr)	Total network delay (Veh-hr/hr)	Highest DOS (%)	Item with highest DOS	Number of oversaturated items	Percentage of oversaturated items (%)	Item with worst signalised PRC	Item with worst unsignalised PRC	Item with worst over PR
4	19/08/2020 12:13:14	19/08/2020 12:13:15	17:00	120	174.67	11.72	60.00	C/1	0	0	C/1	Dx/1	C/

Analysis Set Details

Name	Description	Demand set	Include in report	Locked
DO SOMETHING 2024	PM	D4	✓	

Demand Set Details

Name	Description	Composite	Demand sets	Start time (HH:mm)	Locked
DO SOMETHING 2024	PM			17:00	

Arms and Traffic Streams

Arms

Arm	Name	Description	Traffic node
A	(untitled)		1
Ax	(untitled)		
B	(untitled)		1
Bx	(untitled)		
C	(untitled)		1
Cx	(untitled)		
D	(untitled)		1
Dx	(untitled)		

Traffic Streams

Arm	Traffic Stream	Name	Description	Auto length	Length (m)	Has Saturation Flow	Saturation flow source	Saturation flow (PCU/hr)	Is signal controlled	Is give way	Traffic type	Allow Nearside Turn On Red
A	1	(untitled)		✓	50.00	✓	Sum of lanes	1800	✓		Normal	
Ax	1	(untitled)		✓	137.53						Normal	
B	1	(untitled)		✓	50.00	✓	Sum of lanes	1800	✓		Normal	
Bx	1	(untitled)		✓	138.27						Normal	
C	1	(untitled)		✓	50.00	✓	Sum of lanes	1800	✓		Normal	
	2	(untitled)		✓	50.00	✓	Sum of lanes	1800	✓		Normal	
Cx	1	(untitled)		✓	140.00						Normal	
D	1	(untitled)		✓	50.00	✓	Sum of lanes	1800	✓		Normal	
Dx	1	(untitled)		✓	137.05						Normal	

Lanes

Arm	Traffic Stream	Lane	Name	Description	Use RR67	Saturation flow (PCU/hr)
A	1	1	(untitled)			1800
Ax	1	1	(untitled)			
B	1	1	(untitled)			1800
Bx	1	1	(untitled)			
C	1	1	(untitled)			1800
	2	1	(untitled)			1800
Cx	1	1	(untitled)			
D	1	1	(untitled)			1800
Dx	1	1	(untitled)			

Modelling

Arm	Traffic Stream	Traffic model	Stop weighting multiplier (%)	Delay weighting multiplier (%)	Assignment Cost Weighting (%)	Exclude from results calculation	Max queue storage (PCU)	Has queue limit	Has degree of saturation limit
(ALL)	(ALL)	NetworkDefault	100	100	100		0.00		

Modelling - Advanced

Arm	Traffic Stream	Initial queue (PCU)	Type of Vehicle-in-Service	Vehicle-in-Service	Type of random parameter	Random parameter	Auto cycle time	Cycle time
(ALL)	(ALL)	0.00	NetworkDefault	Not-Included	NetworkDefault	0.50	✓	120

Normal traffic - Modelling

Arm	Traffic Stream	Stop weighting (%)	Delay weighting (%)
(ALL)	(ALL)	100	100

Normal traffic - Advanced

Arm	Traffic Stream	Dispersion type for Normal Traffic
(ALL)	(ALL)	NetworkDefault

Flows

Arm	Traffic Stream	Total Flow (Veh/hr)	Normal Flow (Veh/hr)
A	1	422	422
Ax	1	319	319
B	1	22	22
Bx	1	33	33
C	1	315	315
	2	8	8
Cx	1	403	403
D	1	21	21
Dx	1	33	33

Signals

Arm	Traffic Stream	Controller stream	Phase	Second phase enabled
A	1	1	B	
B	1	1	C	
C	1	1	A	
	2	1	A	
D	1	1	D	

Pedestrian Crossings

Pedestrian Crossings

Crossing	Name	Description	Traffic node	Allow walk on red	Crossing type	Length (m)	Cruise time (seconds)	Cruise speed (kph)
1	(untitled)		1		Farside	7.00	4.67	5.40
2	(untitled)		1		Farside	8.00	5.33	5.40
3	(untitled)		1		Farside	8.00	5.33	5.40
4	(untitled)		1		Farside	7.00	4.67	5.40

Pedestrian Crossings - Signals

Crossing	Controller stream	Phase	Second phase enabled
(ALL)	1	E	

Pedestrian Crossings - Sides

Crossing	Side	Saturation flow (Ped/hr)
(ALL)	(ALL)	11000

Pedestrian Crossings - Modelling

Crossing	Side	Delay weighting (%)	Assignment Cost Weighting (%)	Exclude from results calculation	Max queue storage (Ped)	Has queue limit	Has degree of saturation limit
(ALL)	(ALL)	100	100		0.00		

Local OD Matrix - Local Matrix: 1

Local Matrix Options

OD Matrix	Name	Use for point to point table	Auto calculate	Allocation mode	Allow paths past exit locations	Allow looped paths on arms	Allow looped paths on traffic nodes	Copy flows	Matrix to copy flows from	Limit paths by length	Path length limit multiplier	Limit paths by number	Path number limit
1	(untitled)	✓	✓	Path Equalisation	✓		✓			✓	1.25		

Normal Input Flows (Veh/hr)

		To							
		1	2	3	4	5	6	7	8
From	1	0	21	294	8	0	0	0	0
	2	13	0	8	0	0	0	0	0
	3	385	12	0	25	0	0	0	0
	4	5	0	17	0	0	0	0	0
	5	0	0	0	0	0	0	0	0
	6	0	0	0	0	0	0	0	0
	7	0	0	0	0	0	0	0	0
	8	0	0	0	0	0	0	0	0

Bus Input Flows not shown as they are blank.

Tram Input Flows not shown as they are blank.

Pedestrian Input Flows (Veh/hr)

From	To							
	1	2	3	4	5	6	7	8
1	0	0	0	0	0	0	0	0
2	0	0	0	0	0	0	0	0
3	0	0	0	0	0	0	0	0
4	0	0	0	0	0	0	0	0
5	0	0	0	0	0	30	30	0
6	0	0	0	0	30	0	0	30
7	0	0	0	0	30	0	0	30
8	0	0	0	0	0	30	30	0

Locations

OD Matrix	Location	Name	Entries	Exits	Colour
1	1	(untitled)	C/1, C/2	Cx/1	#0000FF
	2	(untitled)	D/1	Dx/1	#FF0000
	3	(untitled)	A/1	Ax/1	#00FF00
	4	(untitled)	B/1	Bx/1	#FFFF00
	5	(untitled)	3:2E, 1:1E	3:2X, 1:1X	#FF00FF
	6	(untitled)	2:1E, 1:2E	2:1X, 1:2X	#008000
	7	(untitled)	4:2E, 3:1E	4:2X, 3:1X	#FFA500
	8	(untitled)	4:1E, 2:2E	4:1X, 2:2X	#00FFFF

Normal Paths and Flows

OD Matrix	Path	Description	From location	To location	Path items	Allocation type	Normal Calculated Flow (Veh/hr)
1	1		1	2	C/1, Dx/1	Normal	21
	2		1	3	C/1, Ax/1	Normal	294
	5		2	3	D/1, Ax/1	Normal	8
	6		2	4	D/1, Bx/1	Normal	0
	7		2	1	D/1, Cx/1	Normal	13
	8		3	2	A/1, Dx/1	Normal	12
	9		3	4	A/1, Bx/1	Normal	25
	10		3	1	A/1, Cx/1	Normal	385
	11		4	2	B/1, Dx/1	Normal	0
	12		4	3	B/1, Ax/1	Normal	17
	13		4	1	B/1, Cx/1	Normal	5
	21		1	4	C/2, Bx/1	Normal	8

Pedestrian Paths and Flows

OD Matrix	Path	Description	From location	To location	Path items	Allocation type	Pedestrian calculated flow (Ped/hr)
1	17		8	7	4:1E, 4:2X	Normal	30
	18		8	6	2:2E, 2:1X	Normal	30
	22		5	7	3:2E, 3:1X	Normal	30
	23		5	6	1:1E, 1:2X	Normal	30
	34		6	8	2:1E, 2:2X	Normal	30
	35		6	5	1:2E, 1:1X	Normal	30
	41		7	8	4:2E, 4:1X	Normal	30
	42		7	5	3:1E, 3:2X	Normal	30

Signal Timings

Network Default: 120s cycle time; 120 steps

Controller Stream 1

Controller Stream	Name	Description	Use sequence	Cycle time source	Cycle time (s)
1	(untitled)		1	NetworkDefault	120

Controller Stream 1 - Properties

Controller Stream	Manufacturer name	Type	Model number	(Telephone) Line Number	Site number	Grid reference	Gaining delay type
1	Unspecified						Relative

Controller Stream 1 - Optimisation

Controller Stream	Allow offset optimisation	Allow green split optimisation	Optimisation level	Auto redistribute	Enable stage constraint
1	✓	✓	Offsets And Green Splits	✓	

Phases

Controller Stream	Phase	Name	Minimum green (s)	Maximum green (s)	Relative start displacement (s)	Relative end displacement (s)	Type	Blackout Time (s)
1	A	(untitled)	0	300	0	0	Traffic	
	B	(untitled)	0	300	0	0	Traffic	
	C	(untitled)	0	300	0	0	Traffic	
	D	(untitled)	0	5	0	0	Traffic	
	E	(untitled)	5	5	0	0	Pedestrian	0

Library Stages

Controller Stream	Library Stage	Phases in stage	User stage minimum (s)
1	1	A	1
	2	B	1
	3	C	1
	4	D	1
	5	E	1

Stage Sequences

Controller Stream	Sequence	Name	Multiple cycling	Stage IDs	Stage ends
1	1	(untitled)	Single	1, 2, 3, 4, 5	21, 75, 84, 92, 102

Intergreen Matrix for Controller Stream 1

		To				
		A	B	C	D	E
From	A		5	5	5	5
	B	5		5	5	5
	C	5	5		5	5
	D	5	5	5		5
	E	5	5	5	5	

Banned Stage transitions for Controller Stream 1

		To				
		1	2	3	4	5
From	1					
	2					
	3					
	4					
	5					

Interstage Matrix for Controller Stream 1

		To				
		1	2	3	4	5
From	1	0	5	5	5	5
	2	5	0	5	5	5
	3	5	5	0	5	5
	4	5	5	5	0	5
	5	5	5	5	5	0

Resultant Stages

Controller Stream	Resultant Stage	Is base stage	Library Stage ID	Phases in this stage	Stage start (s)	Stage end (s)	Stage duration (s)	User stage minimum (s)	Stage minimum (s)
1	1	✓	1	A	107	21	34	1	1
	2	✓	2	B	26	75	49	1	1
	3	✓	3	C	80	84	4	1	1
	4	✓	4	D	89	92	3	1	1
	5	✓	5	E	97	102	5	1	5

Resultant Phase Green Periods

Controller Stream	Phase	Green period	Is base green period	Start time (s)	End time (s)	Duration (s)
1	A	1	✓	107	21	34
	B	1	✓	26	75	49
	C	1	✓	80	84	4
	D	1	✓	89	92	3
	E	1	✓	97	102	5

Traffic Stream Green Times

Arm	Traffic Stream	Traffic Node	Controller Stream	Phase	Green Period 1		
					Start	End	Duration
A	1	1	1	B	26	75	49
B	1	1	1	C	80	84	4
C	1	1	1	A	107	21	34
C	2	1	1	A	107	21	34
D	1	1	1	D	89	92	3

Phase Timings Diagram for Controller Stream 1

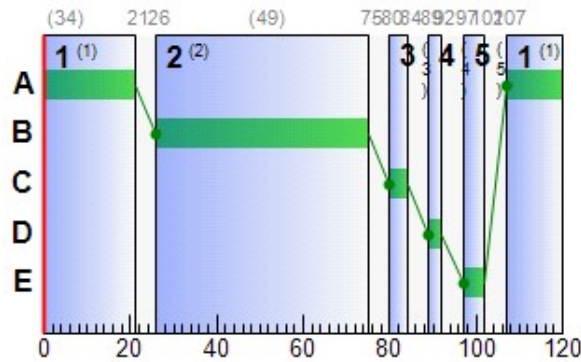

Stage Sequence Diagram for Controller Stream 1

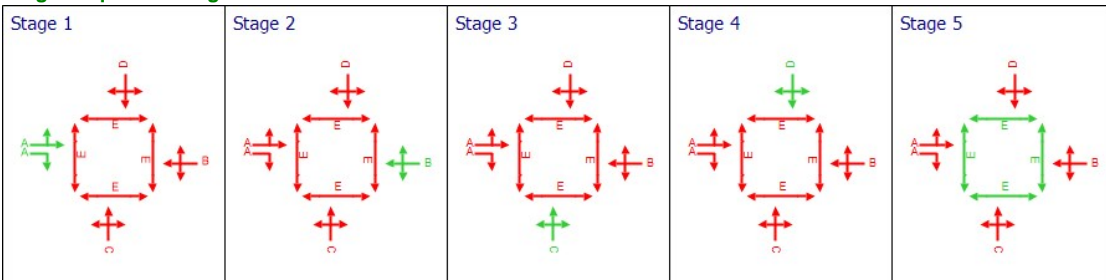

Resultant penalties

Time Segment	Controller stream	Phase min max penalty (£ per hr)	Intergreen broken penalty (£ per hr)	Stage constraint broken penalty (£ per hr)	Cost of controller stream penalties (£ per hr)
17:00-18:00	1	0.00	0.00	0.00	0.00

Traffic Stream Results

Traffic Stream Results: Vehicle summary

Time Segment	Arm	Traffic Stream	Degree of saturation (%)	Practical reserve capacity (%)	Calculated flow entering (Veh/hr)	Calculated sat flow (Veh/hr)	Actual green (s per cycle)	Mean Delay per Veh (s)	Mean max queue (Veh)	Utilised storage (%)	Weighted cost of delay (£ per hr)	Weighted cost of stops (£ per hr)	Performance Index (£ per hr)
17:00-18:00	A	1	56	78	422	1800	49	29.74	11.03	126.81	49.51	4.07	53.58
	Ax	1	0	Unrestricted	319	Unrestricted	120	0.00	0.00	0.00	0.00	0.00	0.00
	B	1	29	241	22	1800	4	65.70	0.77	8.84	5.70	0.29	5.99
	Bx	1	0	Unrestricted	33	Unrestricted	120	0.00	0.00	0.00	0.00	0.00	0.00
	C	1	60	67	315	1800	34	41.58	9.46	108.77	51.67	3.48	55.15
		2	2	6463	8	1800	34	30.51	0.19	2.17	0.96	0.07	1.03
	Cx	1	0	Unrestricted	403	Unrestricted	120	0.00	0.00	0.00	0.00	0.00	0.00
	D	1	35	186	21	1800	3	72.61	0.77	8.91	6.01	0.29	6.30
Dx	1	0	Unrestricted	33	Unrestricted	120	0.00	0.00	0.00	0.00	0.00	0.00	

Traffic Stream Results: Flows and signals

Time Segment	Arm	Traffic Stream	Calculated flow entering (Veh/hr)	Calculated flow out (Veh/hr)	Flow discrepancy (Veh/hr)	Adjusted flow warning	Calculated sat flow (Veh/hr)	Calculated capacity (Veh/hr)	Degree of saturation (%)	DOS Threshold exceeded	Practical reserve capacity (%)	Mean modulus of error	Actual green (s per cycle)
17:00-18:00	A	1	422	422	0		1800	750	56		78	0.00	49
	Ax	1	319	319	0		Unrestricted	Unrestricted	0		Unrestricted	1.18	120
	B	1	22	22	0		1800	75	29		241	0.00	4
	Bx	1	33	33	0		Unrestricted	Unrestricted	0		Unrestricted	0.84	120
	C	1	315	315	0		1800	525	60		67	0.00	34
		2	8	8	0		1800	525	2		6463	0.00	34
	Cx	1	403	403	0		Unrestricted	Unrestricted	0		Unrestricted	1.01	120
	D	1	21	21	0		1800	60	35		186	0.00	3
Dx	1	33	33	0		Unrestricted	Unrestricted	0		Unrestricted	0.78	120	

Traffic Stream Results: Stops and delays

Time Segment	Arm	Traffic Stream	Mean Cruise Time per Veh (s)	Mean Delay per Veh (s)	Uniform delay (Veh-hr/hr)	Random plus oversat delay (Veh-hr/hr)	Weighted cost of delay (£ per hr)	Mean stops per Veh (%)	Uniform stops (Stops per hr)	Random stops (Stops per hr)	Weighted cost of stops (£ per hr)
17:00-18:00	A	1	6.00	29.74	3.13	0.36	49.51	76.99	314.19	10.73	4.07
	Ax	1	16.50	0.00	0.00	0.00	0.00	0.00	0.00	0.00	0.00
	B	1	6.00	65.70	0.34	0.06	5.70	103.71	21.05	1.77	0.29
	Bx	1	16.59	0.00	0.00	0.00	0.00	0.00	0.00	0.00	0.00
	C	1	6.00	41.58	3.19	0.45	51.67	88.21	264.64	13.23	3.48
		2	6.00	30.51	0.07	0.00	0.96	69.89	5.59	0.00	0.07
	Cx	1	16.80	0.00	0.00	0.00	0.00	0.00	0.00	0.00	0.00
	D	1	6.00	72.61	0.33	0.09	6.01	109.25	20.27	2.68	0.29
Dx	1	16.45	0.00	0.00	0.00	0.00	0.00	0.00	0.00	0.00	

Traffic Stream Results: Queues and blocking

Time Segment	Arm	Traffic Stream	Initial queue (Veh)	Mean max queue (Veh)	Max queue storage (Veh)	Utilised storage (%)	Average storage excess queue (Veh)	Average limit excess queue (Veh)	Excess queue penalty (£ per hr)	Wasted time starvation (s (per cycle))	Wasted time blocking back (s (per cycle))	Wasted time total (s (per cycle))	Estimated blocking	
17:00-18:00	A	1	0.00	11.03	8.70	126.81	0.20	0.00	0.00	0.00	0.00	0.00		
	Ax	1	0.00	0.00	23.92	0.00	0.00	0.00	0.00	60.00	0.00	60.00		
	B	1	0.00	0.77	8.70	8.84	0.00	0.00	0.00	2.00	0.00	2.00		
	Bx	1	0.00	0.00	24.05	0.00	0.00	0.00	0.00	94.00	0.00	94.00		
	C	1	0.00	9.46	8.70	108.77	0.03	0.00	0.00	0.00	0.00	0.00	0.00	
		2	0.00	0.19	8.70	2.17	0.00	0.00	0.00	0.00	34.00	0.00	34.00	
	Cx	1	0.00	0.00	24.35	0.00	0.00	0.00	0.00	49.00	0.00	49.00		
	D	1	0.00	0.77	8.70	8.91	0.00	0.00	0.00	0.00	2.00	0.00	2.00	
Dx	1	0.00	0.00	23.84	0.00	0.00	0.00	0.00	0.00	101.00	0.00	101.00		

Pedestrian Crossing Results

Pedestrian Crossings: Pedestrian summary

Time Segment	Crossing	Side	Degree of saturation (%)	Calculated Flow Entering (Ped/hr)	Calculated sat flow (Ped/hr)	Actual green (s (per cycle))	Mean Delay Per Ped (s)	Mean max queue (Ped)	Weighted cost of delay (£ per hr)	Performance Index (£ per hr)
17:00-18:00	(ALL)	(ALL)	7	30	11000	5	55.58	0.96	6.58	6.58

Pedestrian Crossings: Flows and signals

Time Segment	Crossing	Side	Calculated flow entering (Ped/hr)	Calculated flow out (Ped/hr)	Flow discrepancy (Ped/hr)	Adjusted flow warning	Calculated sat flow (Ped/hr)	Calculated capacity (Ped/hr)	Degree of saturation (%)	DOS Threshold exceeded	Practical reserve capacity (%)	Mean modulus of error	Actual green (s (per cycle))
17:00-18:00	(ALL)	(ALL)	30	30	0		11000	458	7		1428	0.00	5

Pedestrian Crossings: Stops and delays

Time Segment	Crossing	Side	Mean Cruise Time per Ped (s)	Mean Delay per Ped (s)	Uniform delay (Ped-hr/hr)	Random plus oversat delay (Ped-hr/hr)	Weighted cost of delay (£ per hr)
17:00-18:00	1	1	5.67	55.58	0.46	0.00	6.58
		2	5.67	55.58	0.46	0.00	6.58
	2	1	6.33	55.58	0.46	0.00	6.58
		2	6.33	55.58	0.46	0.00	6.58
	3	1	6.33	55.58	0.46	0.00	6.58
		2	6.33	55.58	0.46	0.00	6.58
	4	1	5.67	55.58	0.46	0.00	6.58
		2	5.67	55.58	0.46	0.00	6.58

Pedestrian Crossings: Queues and blocking

Time Segment	Crossing	Side	Mean max queue (Ped)	Max queue storage (Ped)	Utilised storage (%)	Average storage excess queue (Ped)	Average limit excess queue (Ped)	Excess queue penalty (£ per hr)
17:00-18:00	(ALL)	(ALL)	0.96	10.00	9.58	0.00	0.00	0.00

Network Results

Network Results: Flows and signals

Time Segment	Calculated flow entering (Veh/hr)	Calculated flow out (Veh/hr)	Flow discrepancy (Veh/hr)	Adjusted flow warning	Degree of saturation (%)	DOS Threshold exceeded	Practical reserve capacity (%)	Actual green (s (per cycle))
17:00-18:00	1816	1816	0		60		67	644

Network Results: Stops and delays

Time Segment	Mean Cruise Time per Veh (s)	Mean Delay per Veh (s)	Uniform delay (Veh-hr/hr)	Random plus oversat delay (Veh-hr/hr)	Weighted cost of delay (£ per hr)	Mean stops per Veh (%)	Uniform stops (Stops per hr)	Random stops (Stops per hr)	Weighted cost of stops (£ per hr)
17:00-18:00	10.62	23.24	10.77	0.96	166.47	36.02	625.74	28.40	8.20

Network Results: Queues and blocking

Time Segment	Utilised storage (%)	Excess queue penalty (£ per hr)	Wasted time starvation (s per cycle))	Wasted time blocking back (s per cycle))	Wasted time total (s per cycle))
17:00-18:00	126.81	0.00	343.00	0.00	343.00

Final Prediction Table

Traffic Stream Results

Arm	Traffic Stream	Name	Traffic node	SIGNALS		FLOWS		PERFORMANCE				PER PCU			QUEUES
				Controller stream	Phase	Calculated flow entering (Veh/hr)	Calculated sat flow (Veh/hr)	Actual green (s per cycle)	Wasted time total (s per cycle)	Degree of saturation (%)	Practical reserve capacity (%)	JourneyTime (s)	Mean Delay per Veh (s)	Mean stops per Veh (%)	Mean max queue (Veh)
A	1	(untitled)	1	1	B	422 <	1800	49	0.00	56	78	35.74	29.74	76.99	11.03 +
Ax	1	(untitled)				319	Unrestricted	120	60.00	0	Unrestricted	16.50	0.00	0.00	0.00
B	1	(untitled)	1	1	C	22	1800	4	3.00	29	241	71.70	65.70	103.71	0.77
Bx	1	(untitled)				33	Unrestricted	120	94.00	0	Unrestricted	16.59	0.00	0.00	0.00
C	1	(untitled)	1	1	A	315 <	1800	34	0.00	60	67	47.58	41.58	88.21	9.46 +
	2	(untitled)	1	1	A	8	1800	34	34.00	2	6463	36.51	30.51	69.89	0.19
Cx	1	(untitled)				403	Unrestricted	120	49.00	0	Unrestricted	16.80	0.00	0.00	0.00
D	1	(untitled)	1	1	D	21	1800	3	2.00	35	186	78.61	72.61	109.25	0.77
Dx	1	(untitled)				33	Unrestricted	120	101.00	0	Unrestricted	16.45	0.00	0.00	0.00

Pedestrian Crossing Results

Pedestrian	Side	Name	Traffic node	SIGNALS		FLOWS		PERFORMANCE			PER PED		QUEUES	WEIGHTS	PEN
				Controller stream	Phase	Calculated Flow Entering (Ped/hr)	Calculated sat flow (Ped/hr)	Actual green (s per cycle)	Degree of saturation (%)	Practical reserve capacity (%)	JourneyTime (s)	Mean Delay per Ped (s)	Mean max queue (Ped)	Delay weighting (%)	Co tra pen (£ p
1	1	(untitled)	1	1	E	30	11000	5	7	1428	61.25	55.58	0.96	100	0
	2	(untitled)	1	1	E	30	11000	5	7	1428	61.25	55.58	0.96	100	0
2	1	(untitled)	1	1	E	30	11000	5	7	1428	61.92	55.58	0.96	100	0
	2	(untitled)	1	1	E	30	11000	5	7	1428	61.92	55.58	0.96	100	0
3	1	(untitled)	1	1	E	30	11000	5	7	1428	61.92	55.58	0.96	100	0
	2	(untitled)	1	1	E	30	11000	5	7	1428	61.92	55.58	0.96	100	0
4	1	(untitled)	1	1	E	30	11000	5	7	1428	61.25	55.58	0.96	100	0
	2	(untitled)	1	1	E	30	11000	5	7	1428	61.25	55.58	0.96	100	0

Network Results

	Distance travelled (PCU-km/hr)	Time spent (PCU-hr/hr)	Mean journey speed (kph)	Uniform delay (Veh-hr/hr)	Random plus oversat delay (Veh-hr/hr)	Weighted cost of delay (£ per hr)	Weighted cost of stops (£ per hr)	Excess queue penalty (£ per hr)	Performance Index (£ per hr)
Normal traffic	148.78	12.98	11.46	7.06	0.96	113.85	8.20	0.00	122.06
Bus	0.00	0.00	0.00	0.00	0.00	0.00	0.00	0.00	0.00
Tram	0.00	0.00	0.00	0.00	0.00	0.00	0.00	0.00	0.00
Pedestrians	2.04	4.11	0.50	3.71	0.00	52.62	0.00	0.00	52.62
TOTAL	150.82	17.08	8.83	10.77	0.96	166.47	8.20	0.00	174.67

- | < = adjusted flow warning (upstream links/traffic streams are over-saturated)
- | * = Traffic Stream - Normal, Bus or Tram Stop or Delay weighting has been set to a value other than 100%
- | ^ = Traffic Stream - Normal, Bus or Tram Stop or Delay Path weighting has been set to a value other than 100%
- | + = average link/traffic stream excess queue is greater than 0
- | **P.I. = PERFORMANCE INDEX**

A5 - DO SOMETHING 2029 D5 - DO SOMETHING 2029*

Summary

Data Errors and Warnings

No errors or warnings

Run Summary

Analysis set used	Run start time	Run finish time	Modelling start time (HH:mm)	Network Cycle Time (s)	Performance Index (£ per hr)	Total network delay (Veh-hr/hr)	Highest DOS (%)	Item with highest DOS	Number of oversaturated items	Percentage of oversaturated items (%)	Item with worst signalised PRC	Item with worst unsignalised PRC	Item with worst over PR
5	19/08/2020 12:13:16	19/08/2020 12:13:16	17:00	120	225.05	15.09	70.39	C/1	0	0	C/1	Dx/1	C/

Analysis Set Details

Name	Description	Demand set	Include in report	Locked
DO SOMETHING 2029	PM	D5	✓	

Demand Set Details

Name	Description	Composite	Demand sets	Start time (HH:mm)	Locked
DO SOMETHING 2029	PM			17:00	

Arms and Traffic Streams

Arms

Arm	Name	Description	Traffic node
A	(untitled)		1
Ax	(untitled)		
B	(untitled)		1
Bx	(untitled)		
C	(untitled)		1
Cx	(untitled)		
D	(untitled)		1
Dx	(untitled)		

Traffic Streams

Arm	Traffic Stream	Name	Description	Auto length	Length (m)	Has Saturation Flow	Saturation flow source	Saturation flow (PCU/hr)	Is signal controlled	Is give way	Traffic type	Allow Nearside Turn On Red
A	1	(untitled)		✓	50.00	✓	Sum of lanes	1800	✓		Normal	
Ax	1	(untitled)		✓	137.53						Normal	
B	1	(untitled)		✓	50.00	✓	Sum of lanes	1800	✓		Normal	
Bx	1	(untitled)		✓	138.27						Normal	
C	1	(untitled)		✓	50.00	✓	Sum of lanes	1800	✓		Normal	
	2	(untitled)		✓	50.00	✓	Sum of lanes	1800	✓		Normal	
Cx	1	(untitled)		✓	140.00						Normal	
D	1	(untitled)		✓	50.00	✓	Sum of lanes	1800	✓		Normal	
Dx	1	(untitled)		✓	137.05						Normal	

Lanes

Arm	Traffic Stream	Lane	Name	Description	Use RR67	Saturation flow (PCU/hr)
A	1	1	(untitled)			1800
Ax	1	1	(untitled)			
B	1	1	(untitled)			1800
Bx	1	1	(untitled)			
C	1	1	(untitled)			1800
	2	1	(untitled)			1800
Cx	1	1	(untitled)			
D	1	1	(untitled)			1800
Dx	1	1	(untitled)			

Modelling

Arm	Traffic Stream	Traffic model	Stop weighting multiplier (%)	Delay weighting multiplier (%)	Assignment Cost Weighting (%)	Exclude from results calculation	Max queue storage (PCU)	Has queue limit	Has degree of saturation limit
(ALL)	(ALL)	NetworkDefault	100	100	100		0.00		

Modelling - Advanced

Arm	Traffic Stream	Initial queue (PCU)	Type of Vehicle-in-Service	Vehicle-in-Service	Type of random parameter	Random parameter	Auto cycle time	Cycle time
(ALL)	(ALL)	0.00	NetworkDefault	Not-Included	NetworkDefault	0.50	✓	120

Normal traffic - Modelling

Arm	Traffic Stream	Stop weighting (%)	Delay weighting (%)
(ALL)	(ALL)	100	100

Normal traffic - Advanced

Arm	Traffic Stream	Dispersion type for Normal Traffic
(ALL)	(ALL)	NetworkDefault

Flows

Arm	Traffic Stream	Total Flow (Veh/hr)	Normal Flow (Veh/hr)
A	1	490	490
Ax	1	401	401
B	1	70	70
Bx	1	63	63
C	1	359	359
	2	14	14
Cx	1	457	457
D	1	21	21
Dx	1	33	33

Signals

Arm	Traffic Stream	Controller stream	Phase	Second phase enabled
A	1	1	B	
B	1	1	C	
C	1	1	A	
	2	1	A	
D	1	1	D	

Pedestrian Crossings

Pedestrian Crossings

Crossing	Name	Description	Traffic node	Allow walk on red	Crossing type	Length (m)	Cruise time (seconds)	Cruise speed (kph)
1	(untitled)		1		Farside	7.00	4.67	5.40
2	(untitled)		1		Farside	8.00	5.33	5.40
3	(untitled)		1		Farside	8.00	5.33	5.40
4	(untitled)		1		Farside	7.00	4.67	5.40

Pedestrian Crossings - Signals

Crossing	Controller stream	Phase	Second phase enabled
(ALL)	1	E	

Pedestrian Crossings - Sides

Crossing	Side	Saturation flow (Ped/hr)
(ALL)	(ALL)	11000

Pedestrian Crossings - Modelling

Crossing	Side	Delay weighting (%)	Assignment Cost Weighting (%)	Exclude from results calculation	Max queue storage (Ped)	Has queue limit	Has degree of saturation limit
(ALL)	(ALL)	100	100		0.00		

Local OD Matrix - Local Matrix: 1

Local Matrix Options

OD Matrix	Name	Use for point to point table	Auto calculate	Allocation mode	Allow paths past exit locations	Allow looped paths on arms	Allow looped paths on traffic nodes	Copy flows	Matrix to copy flows from	Limit paths by length	Path length limit multiplier	Limit paths by number	Path number limit
1	(untitled)	✓	✓	Path Equalisation	✓		✓			✓	1.25		

Normal Input Flows (Veh/hr)

		To							
		1	2	3	4	5	6	7	8
From	1	0	21	338	14	0	0	0	0
	2	13	0	8	0	0	0	0	0
	3	429	12	0	49	0	0	0	0
	4	15	0	55	0	0	0	0	0
	5	0	0	0	0	0	0	0	0
	6	0	0	0	0	0	0	0	0
	7	0	0	0	0	0	0	0	0
	8	0	0	0	0	0	0	0	0

Bus Input Flows not shown as they are blank.

Tram Input Flows not shown as they are blank.

Pedestrian Input Flows (Veh/hr)

From	To							
	1	2	3	4	5	6	7	8
1	0	0	0	0	0	0	0	0
2	0	0	0	0	0	0	0	0
3	0	0	0	0	0	0	0	0
4	0	0	0	0	0	0	0	0
5	0	0	0	0	0	30	30	0
6	0	0	0	0	30	0	0	30
7	0	0	0	0	30	0	0	30
8	0	0	0	0	0	30	30	0

Locations

OD Matrix	Location	Name	Entries	Exits	Colour
1	1	(untitled)	C/1, C/2	Cx/1	#0000FF
	2	(untitled)	D/1	Dx/1	#FF0000
	3	(untitled)	A/1	Ax/1	#00FF00
	4	(untitled)	B/1	Bx/1	#FFFF00
	5	(untitled)	3:2E, 1:1E	3:2X, 1:1X	#FF00FF
	6	(untitled)	2:1E, 1:2E	2:1X, 1:2X	#008000
	7	(untitled)	4:2E, 3:1E	4:2X, 3:1X	#FFA500
	8	(untitled)	4:1E, 2:2E	4:1X, 2:2X	#00FFFF

Normal Paths and Flows

OD Matrix	Path	Description	From location	To location	Path items	Allocation type	Normal Calculated Flow (Veh/hr)
1	1		1	2	C/1, Dx/1	Normal	21
	2		1	3	C/1, Ax/1	Normal	338
	5		2	3	D/1, Ax/1	Normal	8
	6		2	4	D/1, Bx/1	Normal	0
	7		2	1	D/1, Cx/1	Normal	13
	8		3	2	A/1, Dx/1	Normal	12
	9		3	4	A/1, Bx/1	Normal	49
	10		3	1	A/1, Cx/1	Normal	429
	11		4	2	B/1, Dx/1	Normal	0
	12		4	3	B/1, Ax/1	Normal	55
	13		4	1	B/1, Cx/1	Normal	15
	21		1	4	C/2, Bx/1	Normal	14

Pedestrian Paths and Flows

OD Matrix	Path	Description	From location	To location	Path items	Allocation type	Pedestrian calculated flow (Ped/hr)
1	17		8	7	4:1E, 4:2X	Normal	30
	18		8	6	2:2E, 2:1X	Normal	30
	22		5	7	3:2E, 3:1X	Normal	30
	23		5	6	1:1E, 1:2X	Normal	30
	34		6	8	2:1E, 2:2X	Normal	30
	35		6	5	1:2E, 1:1X	Normal	30
	41		7	8	4:2E, 4:1X	Normal	30
	42		7	5	3:1E, 3:2X	Normal	30

Signal Timings

Network Default: 120s cycle time; 120 steps

Controller Stream 1

Controller Stream	Name	Description	Use sequence	Cycle time source	Cycle time (s)
1	(untitled)		1	NetworkDefault	120

Controller Stream 1 - Properties

Controller Stream	Manufacturer name	Type	Model number	(Telephone) Line Number	Site number	Grid reference	Gaining delay type
1	Unspecified						Relative

Controller Stream 1 - Optimisation

Controller Stream	Allow offset optimisation	Allow green split optimisation	Optimisation level	Auto redistribute	Enable stage constraint
1	✓	✓	Offsets And Green Splits	✓	

Phases

Controller Stream	Phase	Name	Minimum green (s)	Maximum green (s)	Relative start displacement (s)	Relative end displacement (s)	Type	Blackout Time (s)
1	A	(untitled)	0	300	0	0	Traffic	
	B	(untitled)	0	300	0	0	Traffic	
	C	(untitled)	0	300	0	0	Traffic	
	D	(untitled)	0	5	0	0	Traffic	
	E	(untitled)	5	5	0	0	Pedestrian	0

Library Stages

Controller Stream	Library Stage	Phases in stage	User stage minimum (s)
1	1	A	1
	2	B	1
	3	C	1
	4	D	1
	5	E	1

Stage Sequences

Controller Stream	Sequence	Name	Multiple cycling	Stage IDs	Stage ends
1	1	(untitled)	Single	1, 2, 3, 4, 5	20, 72, 85, 92, 102

Intergreen Matrix for Controller Stream 1

		To				
		A	B	C	D	E
From	A		5	5	5	5
	B	5		5	5	5
	C	5	5		5	5
	D	5	5	5		5
	E	5	5	5	5	

Banned Stage transitions for Controller Stream 1

		To				
		1	2	3	4	5
From	1					
	2					
	3					
	4					
	5					

Interstage Matrix for Controller Stream 1

		To				
		1	2	3	4	5
From	1	0	5	5	5	5
	2	5	0	5	5	5
	3	5	5	0	5	5
	4	5	5	5	0	5
	5	5	5	5	5	0

Resultant Stages

Controller Stream	Resultant Stage	Is base stage	Library Stage ID	Phases in this stage	Stage start (s)	Stage end (s)	Stage duration (s)	User stage minimum (s)	Stage minimum (s)
1	1	✓	1	A	107	20	33	1	1
	2	✓	2	B	25	72	47	1	1
	3	✓	3	C	77	85	8	1	1
	4	✓	4	D	90	92	2	1	1
	5	✓	5	E	97	102	5	1	5

Resultant Phase Green Periods

Controller Stream	Phase	Green period	Is base green period	Start time (s)	End time (s)	Duration (s)
1	A	1	✓	107	20	33
	B	1	✓	25	72	47
	C	1	✓	77	85	8
	D	1	✓	90	92	2
	E	1	✓	97	102	5

Traffic Stream Green Times

Arm	Traffic Stream	Traffic Node	Controller Stream	Phase	Green Period 1		
					Start	End	Duration
A	1	1	1	B	25	72	47
B	1	1	1	C	77	85	8
C	1	1	1	A	107	20	33
C	2	1	1	A	107	20	33
D	1	1	1	D	90	92	2

Phase Timings Diagram for Controller Stream 1

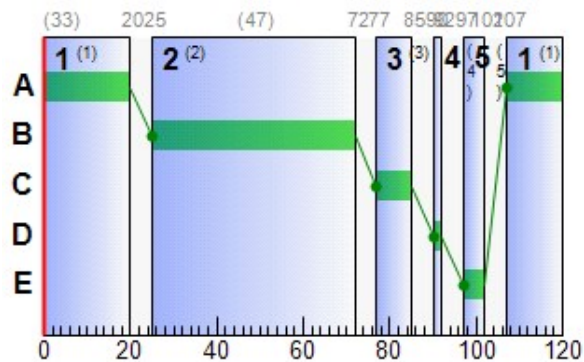

Stage Sequence Diagram for Controller Stream 1

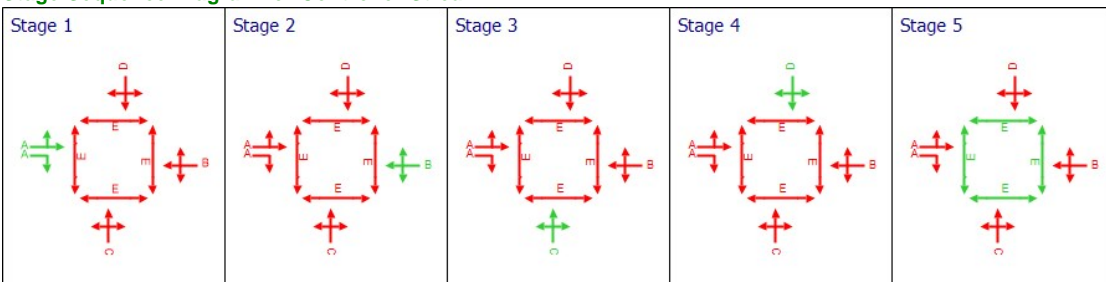

Resultant penalties

Time Segment	Controller stream	Phase min max penalty (£ per hr)	Intergreen broken penalty (£ per hr)	Stage constraint broken penalty (£ per hr)	Cost of controller stream penalties (£ per hr)
17:00-18:00	1	0.00	0.00	0.00	0.00

Traffic Stream Results

Traffic Stream Results: Vehicle summary

Time Segment	Arm	Traffic Stream	Degree of saturation (%)	Practical reserve capacity (%)	Calculated flow entering (Veh/hr)	Calculated sat flow (Veh/hr)	Actual green (s per cycle)	Mean Delay per Veh (s)	Mean max queue (Veh)	Utilised storage (%)	Weighted cost of delay (£ per hr)	Weighted cost of stops (£ per hr)	Performance Index (£ per hr)
17:00-18:00	A	1	68	47	490	1800	47	34.94	14.06	161.63	67.54	5.21	72.74
	Ax	1	0	Unrestricted	401	Unrestricted	120	0.00	0.00	0.00	0.00	0.00	0.00
	B	1	52	93	70	1800	8	67.46	2.51	28.85	18.63	0.93	19.56
	Bx	1	0	Unrestricted	63	Unrestricted	120	0.00	0.00	0.00	0.00	0.00	0.00
	C	1	70	42	359	1800	33	46.72	11.49	132.14	66.16	4.26	70.42
		2	3	3543	14	1800	33	31.27	0.33	3.85	1.73	0.12	1.85
	Cx	1	0	Unrestricted	457	Unrestricted	120	0.00	0.00	0.00	0.00	0.00	0.00
	D	1	47	114	21	1800	2	90.98	0.88	10.14	7.54	0.32	7.86
Dx	1	0	Unrestricted	33	Unrestricted	120	0.00	0.00	0.00	0.00	0.00	0.00	

Traffic Stream Results: Flows and signals

Time Segment	Arm	Traffic Stream	Calculated flow entering (Veh/hr)	Calculated flow out (Veh/hr)	Flow discrepancy (Veh/hr)	Adjusted flow warning	Calculated sat flow (Veh/hr)	Calculated capacity (Veh/hr)	Degree of saturation (%)	DOS Threshold exceeded	Practical reserve capacity (%)	Mean modulus of error	Actual green (s per cycle)
17:00-18:00	A	1	490	490	0		1800	720	68		47	0.00	47
	Ax	1	401	401	0		Unrestricted	Unrestricted	0		Unrestricted	1.10	120
	B	1	70	70	0		1800	135	52		93	0.00	8
	Bx	1	63	63	0		Unrestricted	Unrestricted	0		Unrestricted	0.86	120
	C	1	359	359	0		1800	510	70		42	0.00	33
		2	14	14	0		1800	510	3		3543	0.00	33
	Cx	1	457	457	0		Unrestricted	Unrestricted	0		Unrestricted	1.01	120
	D	1	21	21	0		1800	45	47		114	0.00	2
Dx	1	33	33	0		Unrestricted	Unrestricted	0		Unrestricted	0.75	120	

Traffic Stream Results: Stops and delays

Time Segment	Arm	Traffic Stream	Mean Cruise Time per Veh (s)	Mean Delay per Veh (s)	Uniform delay (Veh-hr/hr)	Random plus oversat delay (Veh-hr/hr)	Weighted cost of delay (£ per hr)	Mean stops per Veh (%)	Uniform stops (Stops per hr)	Random stops (Stops per hr)	Weighted cost of stops (£ per hr)
17:00-18:00	A	1	6.00	34.94	4.04	0.72	67.54	84.76	394.06	21.25	5.21
	Ax	1	16.50	0.00	0.00	0.00	0.00	0.00	0.00	0.00	0.00
	B	1	6.00	67.46	1.04	0.27	18.63	106.20	66.39	7.94	0.93
	Bx	1	16.59	0.00	0.00	0.00	0.00	0.00	0.00	0.00	0.00
	C	1	6.00	46.72	3.84	0.82	66.16	94.60	315.42	24.19	4.26
		2	6.00	31.27	0.12	0.00	1.73	70.76	9.90	0.01	0.12
	Cx	1	16.80	0.00	0.00	0.00	0.00	0.00	0.00	0.00	0.00
	D	1	6.00	90.98	0.34	0.19	7.54	123.18	20.44	5.42	0.32
Dx	1	16.45	0.00	0.00	0.00	0.00	0.00	0.00	0.00	0.00	

Traffic Stream Results: Queues and blocking

Time Segment	Arm	Traffic Stream	Initial queue (Veh)	Mean max queue (Veh)	Max queue storage (Veh)	Utilised storage (%)	Average storage excess queue (Veh)	Average limit excess queue (Veh)	Excess queue penalty (£ per hr)	Wasted time starvation (s (per cycle))	Wasted time blocking back (s (per cycle))	Wasted time total (s (per cycle))	Estimated blocking	
17:00-18:00	A	1	0.00	14.06	8.70	161.63	0.90	0.00	0.00	0.00	0.00	0.00		
	Ax	1	0.00	0.00	23.92	0.00	0.00	0.00	0.00	54.00	0.00	54.00		
	B	1	0.00	2.51	8.70	28.85	0.00	0.00	0.00	0.00	0.00	0.00		
	Bx	1	0.00	0.00	24.05	0.00	0.00	0.00	0.00	74.00	0.00	74.00		
	C	1	0.00	11.49	8.70	132.14	0.34	0.00	0.00	0.00	0.00	0.00	0.00	
		2	0.00	0.33	8.70	3.85	0.00	0.00	0.00	0.00	33.00	0.00	33.00	
	Cx	1	0.00	0.00	24.35	0.00	0.00	0.00	0.00	45.00	0.00	45.00		
	D	1	0.00	0.88	8.70	10.14	0.00	0.00	0.00	1.00	0.00	1.00		
Dx	1	0.00	0.00	23.84	0.00	0.00	0.00	0.00	99.00	0.00	99.00			

Pedestrian Crossing Results

Pedestrian Crossings: Pedestrian summary

Time Segment	Crossing	Side	Degree of saturation (%)	Calculated Flow Entering (Ped/hr)	Calculated sat flow (Ped/hr)	Actual green (s (per cycle))	Mean Delay Per Ped (s)	Mean max queue (Ped)	Weighted cost of delay (£ per hr)	Performance Index (£ per hr)
17:00-18:00	(ALL)	(ALL)	7	30	11000	5	55.58	0.96	6.58	6.58

Pedestrian Crossings: Flows and signals

Time Segment	Crossing	Side	Calculated flow entering (Ped/hr)	Calculated flow out (Ped/hr)	Flow discrepancy (Ped/hr)	Adjusted flow warning	Calculated sat flow (Ped/hr)	Calculated capacity (Ped/hr)	Degree of saturation (%)	DOS Threshold exceeded	Practical reserve capacity (%)	Mean modulus of error	Actual green (s (per cycle))
17:00-18:00	(ALL)	(ALL)	30	30	0		11000	458	7		1428	0.00	5

Pedestrian Crossings: Stops and delays

Time Segment	Crossing	Side	Mean Cruise Time per Ped (s)	Mean Delay per Ped (s)	Uniform delay (Ped-hr/hr)	Random plus oversat delay (Ped-hr/hr)	Weighted cost of delay (£ per hr)
17:00-18:00	1	1	5.67	55.58	0.46	0.00	6.58
		2	5.67	55.58	0.46	0.00	6.58
	2	1	6.33	55.58	0.46	0.00	6.58
		2	6.33	55.58	0.46	0.00	6.58
	3	1	6.33	55.58	0.46	0.00	6.58
		2	6.33	55.58	0.46	0.00	6.58
	4	1	5.67	55.58	0.46	0.00	6.58
		2	5.67	55.58	0.46	0.00	6.58

Pedestrian Crossings: Queues and blocking

Time Segment	Crossing	Side	Mean max queue (Ped)	Max queue storage (Ped)	Utilised storage (%)	Average storage excess queue (Ped)	Average limit excess queue (Ped)	Excess queue penalty (£ per hr)
17:00-18:00	(ALL)	(ALL)	0.96	10.00	9.58	0.00	0.00	0.00

Network Results

Network Results: Flows and signals

Time Segment	Calculated flow entering (Veh/hr)	Calculated flow out (Veh/hr)	Flow discrepancy (Veh/hr)	Adjusted flow warning	Degree of saturation (%)	DOS Threshold exceeded	Practical reserve capacity (%)	Actual green (s (per cycle))
17:00-18:00	2148	2148	0		70		42	643

Network Results: Stops and delays

Time Segment	Mean Cruise Time per Veh (s)	Mean Delay per Veh (s)	Uniform delay (Veh-hr/hr)	Random plus oversat delay (Veh-hr/hr)	Weighted cost of delay (£ per hr)	Mean stops per Veh (%)	Uniform stops (Stops per hr)	Random stops (Stops per hr)	Weighted cost of stops (£ per hr)
17:00-18:00	10.73	25.28	13.08	2.00	214.21	40.27	806.21	58.82	10.85

Network Results: Queues and blocking

Time Segment	Utilised storage (%)	Excess queue penalty (£ per hr)	Wasted time starvation (s per cycle))	Wasted time blocking back (s per cycle))	Wasted time total (s per cycle))
17:00-18:00	161.63	0.00	306.00	0.00	306.00

Final Prediction Table

Traffic Stream Results

Arm	Traffic Stream	Name	Traffic node	SIGNALS		FLOWS		PERFORMANCE				PER PCU			QUEUES
				Controller stream	Phase	Calculated flow entering (Veh/hr)	Calculated sat flow (Veh/hr)	Actual green (s per cycle)	Wasted time total (s per cycle)	Degree of saturation (%)	Practical reserve capacity (%)	JourneyTime (s)	Mean Delay per Veh (s)	Mean stops per Veh (%)	Mean max queue (Veh)
A	1	(untitled)	1	1	B	490 <	1800	47	0.00	68	47	40.94	34.94	84.76	14.06 +
Ax	1	(untitled)				401	Unrestricted	120	54.00	0	Unrestricted	16.50	0.00	0.00	0.00
B	1	(untitled)	1	1	C	70	1800	8	0.00	52	93	73.46	67.46	106.20	2.51
Bx	1	(untitled)				63	Unrestricted	120	74.00	0	Unrestricted	16.59	0.00	0.00	0.00
C	1	(untitled)	1	1	A	359 <	1800	33	0.00	70	42	52.72	46.72	94.60	11.49 +
	2	(untitled)	1	1	A	14	1800	33	33.00	3	3543	37.27	31.27	70.76	0.33
Cx	1	(untitled)				457	Unrestricted	120	45.00	0	Unrestricted	16.80	0.00	0.00	0.00
D	1	(untitled)	1	1	D	21	1800	2	1.00	47	114	96.98	90.98	123.18	0.88
Dx	1	(untitled)				33	Unrestricted	120	99.00	0	Unrestricted	16.45	0.00	0.00	0.00

Pedestrian Crossing Results

Pedestrian	Side	Name	Traffic node	SIGNALS		FLOWS		PERFORMANCE			PER PED		QUEUES	WEIGHTS	PEN
				Controller stream	Phase	Calculated Flow Entering (Ped/hr)	Calculated sat flow (Ped/hr)	Actual green (s per cycle)	Degree of saturation (%)	Practical reserve capacity (%)	JourneyTime (s)	Mean Delay per Ped (s)	Mean max queue (Ped)	Delay weighting (%)	Co tra pen (£ p
1	1	(untitled)	1	1	E	30	11000	5	7	1428	61.25	55.58	0.96	100	0
	2	(untitled)	1	1	E	30	11000	5	7	1428	61.25	55.58	0.96	100	0
2	1	(untitled)	1	1	E	30	11000	5	7	1428	61.92	55.58	0.96	100	0
	2	(untitled)	1	1	E	30	11000	5	7	1428	61.92	55.58	0.96	100	0
3	1	(untitled)	1	1	E	30	11000	5	7	1428	61.92	55.58	0.96	100	0
	2	(untitled)	1	1	E	30	11000	5	7	1428	61.92	55.58	0.96	100	0
4	1	(untitled)	1	1	E	30	11000	5	7	1428	61.25	55.58	0.96	100	0
	2	(untitled)	1	1	E	30	11000	5	7	1428	61.25	55.58	0.96	100	0

Network Results

	Distance travelled (PCU-km/hr)	Time spent (PCU-hr/hr)	Mean journey speed (kph)	Uniform delay (Veh-hr/hr)	Random plus oversat delay (Veh-hr/hr)	Weighted cost of delay (£ per hr)	Weighted cost of stops (£ per hr)	Excess queue penalty (£ per hr)	Performance Index (£ per hr)
Normal traffic	180.06	17.38	10.36	9.38	2.00	161.59	10.85	0.00	172.43
Bus	0.00	0.00	0.00	0.00	0.00	0.00	0.00	0.00	0.00
Tram	0.00	0.00	0.00	0.00	0.00	0.00	0.00	0.00	0.00
Pedestrians	2.04	4.11	0.50	3.71	0.00	52.62	0.00	0.00	52.62
TOTAL	182.10	21.49	8.48	13.08	2.00	214.21	10.85	0.00	225.05

- | < = adjusted flow warning (upstream links/traffic streams are over-saturated)
- | * = Traffic Stream - Normal, Bus or Tram Stop or Delay weighting has been set to a value other than 100%
- | ^ = Traffic Stream - Normal, Bus or Tram Stop or Delay Path weighting has been set to a value other than 100%
- | + = average link/traffic stream excess queue is greater than 0
- | **P.I. = PERFORMANCE INDEX**

A6 - DO SOMETHING 2039 D6 - DO SOMETHING 2039*

Summary

Data Errors and Warnings

No errors or warnings

Run Summary

Analysis set used	Run start time	Run finish time	Modelling start time (HH:mm)	Network Cycle Time (s)	Performance Index (£ per hr)	Total network delay (Veh-hr/hr)	Highest DOS (%)	Item with highest DOS	Number of oversaturated items	Percentage of oversaturated items (%)	Item with worst signalised PRC	Item with worst unsignalised PRC	Item with worst over PR
6	19/08/2020 12:13:18	19/08/2020 12:13:19	17:00	120	241.36	16.17	74.71	C/1	0	0	C/1	Dx/1	C/

Analysis Set Details

Name	Description	Demand set	Include in report	Locked
DO SOMETHING 2039	PM	D6	✓	

Demand Set Details

Name	Description	Composite	Demand sets	Start time (HH:mm)	Locked
DO SOMETHING 2039	PM			17:00	

Arms and Traffic Streams

Arms

Arm	Name	Description	Traffic node
A	(untitled)		1
Ax	(untitled)		
B	(untitled)		1
Bx	(untitled)		
C	(untitled)		1
Cx	(untitled)		
D	(untitled)		1
Dx	(untitled)		

Traffic Streams

Arm	Traffic Stream	Name	Description	Auto length	Length (m)	Has Saturation Flow	Saturation flow source	Saturation flow (PCU/hr)	Is signal controlled	Is give way	Traffic type	Allow Nearside Turn On Red
A	1	(untitled)		✓	50.00	✓	Sum of lanes	1800	✓		Normal	
Ax	1	(untitled)		✓	137.53						Normal	
B	1	(untitled)		✓	50.00	✓	Sum of lanes	1800	✓		Normal	
Bx	1	(untitled)		✓	138.27						Normal	
C	1	(untitled)		✓	50.00	✓	Sum of lanes	1800	✓		Normal	
	2	(untitled)		✓	50.00	✓	Sum of lanes	1800	✓		Normal	
Cx	1	(untitled)		✓	140.00						Normal	
D	1	(untitled)		✓	50.00	✓	Sum of lanes	1800	✓		Normal	
Dx	1	(untitled)		✓	137.05						Normal	

Lanes

Arm	Traffic Stream	Lane	Name	Description	Use RR67	Saturation flow (PCU/hr)
A	1	1	(untitled)			1800
Ax	1	1	(untitled)			
B	1	1	(untitled)			1800
Bx	1	1	(untitled)			
C	1	1	(untitled)			1800
	2	1	(untitled)			1800
Cx	1	1	(untitled)			
D	1	1	(untitled)			1800
Dx	1	1	(untitled)			

Modelling

Arm	Traffic Stream	Traffic model	Stop weighting multiplier (%)	Delay weighting multiplier (%)	Assignment Cost Weighting (%)	Exclude from results calculation	Max queue storage (PCU)	Has queue limit	Has degree of saturation limit
(ALL)	(ALL)	NetworkDefault	100	100	100		0.00		

Modelling - Advanced

Arm	Traffic Stream	Initial queue (PCU)	Type of Vehicle-in-Service	Vehicle-in-Service	Type of random parameter	Random parameter	Auto cycle time	Cycle time
(ALL)	(ALL)	0.00	NetworkDefault	Not-Included	NetworkDefault	0.50	✓	120

Normal traffic - Modelling

Arm	Traffic Stream	Stop weighting (%)	Delay weighting (%)
(ALL)	(ALL)	100	100

Normal traffic - Advanced

Arm	Traffic Stream	Dispersion type for Normal Traffic
(ALL)	(ALL)	NetworkDefault

Flows

Arm	Traffic Stream	Total Flow (Veh/hr)	Normal Flow (Veh/hr)
A	1	519	519
Ax	1	423	423
B	1	70	70
Bx	1	63	63
C	1	381	381
	2	14	14
Cx	1	486	486
D	1	21	21
Dx	1	33	33

Signals

Arm	Traffic Stream	Controller stream	Phase	Second phase enabled
A	1	1	B	
B	1	1	C	
C	1	1	A	
	2	1	A	
D	1	1	D	

Pedestrian Crossings

Pedestrian Crossings

Crossing	Name	Description	Traffic node	Allow walk on red	Crossing type	Length (m)	Cruise time (seconds)	Cruise speed (kph)
1	(untitled)		1		Farside	7.00	4.67	5.40
2	(untitled)		1		Farside	8.00	5.33	5.40
3	(untitled)		1		Farside	8.00	5.33	5.40
4	(untitled)		1		Farside	7.00	4.67	5.40

Pedestrian Crossings - Signals

Crossing	Controller stream	Phase	Second phase enabled
(ALL)	1	E	

Pedestrian Crossings - Sides

Crossing	Side	Saturation flow (Ped/hr)
(ALL)	(ALL)	11000

Pedestrian Crossings - Modelling

Crossing	Side	Delay weighting (%)	Assignment Cost Weighting (%)	Exclude from results calculation	Max queue storage (Ped)	Has queue limit	Has degree of saturation limit
(ALL)	(ALL)	100	100		0.00		

Local OD Matrix - Local Matrix: 1

Local Matrix Options

OD Matrix	Name	Use for point to point table	Auto calculate	Allocation mode	Allow paths past exit locations	Allow looped paths on arms	Allow looped paths on traffic nodes	Copy flows	Matrix to copy flows from	Limit paths by length	Path length limit multiplier	Limit paths by number	Path number limit
1	(untitled)	✓	✓	Path Equalisation	✓		✓			✓	1.25		

Normal Input Flows (Veh/hr)

		To							
		1	2	3	4	5	6	7	8
From	1	0	21	360	14	0	0	0	0
	2	13	0	8	0	0	0	0	0
	3	458	12	0	49	0	0	0	0
	4	15	0	55	0	0	0	0	0
	5	0	0	0	0	0	0	0	0
	6	0	0	0	0	0	0	0	0
	7	0	0	0	0	0	0	0	0
	8	0	0	0	0	0	0	0	0

Bus Input Flows not shown as they are blank.

Tram Input Flows not shown as they are blank.

Pedestrian Input Flows (Veh/hr)

From	To							
	1	2	3	4	5	6	7	8
1	0	0	0	0	0	0	0	0
2	0	0	0	0	0	0	0	0
3	0	0	0	0	0	0	0	0
4	0	0	0	0	0	0	0	0
5	0	0	0	0	0	30	30	0
6	0	0	0	0	30	0	0	30
7	0	0	0	0	30	0	0	30
8	0	0	0	0	0	30	30	0

Locations

OD Matrix	Location	Name	Entries	Exits	Colour
1	1	(untitled)	C/1, C/2	Cx/1	#0000FF
	2	(untitled)	D/1	Dx/1	#FF0000
	3	(untitled)	A/1	Ax/1	#00FF00
	4	(untitled)	B/1	Bx/1	#FFFF00
	5	(untitled)	3:2E, 1:1E	3:2X, 1:1X	#FF00FF
	6	(untitled)	2:1E, 1:2E	2:1X, 1:2X	#008000
	7	(untitled)	4:2E, 3:1E	4:2X, 3:1X	#FFA500
	8	(untitled)	4:1E, 2:2E	4:1X, 2:2X	#00FFFF

Normal Paths and Flows

OD Matrix	Path	Description	From location	To location	Path items	Allocation type	Normal Calculated Flow (Veh/hr)
1	1		1	2	C/1, Dx/1	Normal	21
	2		1	3	C/1, Ax/1	Normal	360
	5		2	3	D/1, Ax/1	Normal	8
	6		2	4	D/1, Bx/1	Normal	0
	7		2	1	D/1, Cx/1	Normal	13
	8		3	2	A/1, Dx/1	Normal	12
	9		3	4	A/1, Bx/1	Normal	49
	10		3	1	A/1, Cx/1	Normal	458
	11		4	2	B/1, Dx/1	Normal	0
	12		4	3	B/1, Ax/1	Normal	55
	13		4	1	B/1, Cx/1	Normal	15
	21		1	4	C/2, Bx/1	Normal	14

Pedestrian Paths and Flows

OD Matrix	Path	Description	From location	To location	Path items	Allocation type	Pedestrian calculated flow (Ped/hr)
1	17		8	7	4:1E, 4:2X	Normal	30
	18		8	6	2:2E, 2:1X	Normal	30
	22		5	7	3:2E, 3:1X	Normal	30
	23		5	6	1:1E, 1:2X	Normal	30
	34		6	8	2:1E, 2:2X	Normal	30
	35		6	5	1:2E, 1:1X	Normal	30
	41		7	8	4:2E, 4:1X	Normal	30
	42		7	5	3:1E, 3:2X	Normal	30

Signal Timings

Network Default: 120s cycle time; 120 steps

Controller Stream 1

Controller Stream	Name	Description	Use sequence	Cycle time source	Cycle time (s)
1	(untitled)		1	NetworkDefault	120

Controller Stream 1 - Properties

Controller Stream	Manufacturer name	Type	Model number	(Telephone) Line Number	Site number	Grid reference	Gaining delay type
1	Unspecified						Relative

Controller Stream 1 - Optimisation

Controller Stream	Allow offset optimisation	Allow green split optimisation	Optimisation level	Auto redistribute	Enable stage constraint
1	✓	✓	Offsets And Green Splits	✓	

Phases

Controller Stream	Phase	Name	Minimum green (s)	Maximum green (s)	Relative start displacement (s)	Relative end displacement (s)	Type	Blackout Time (s)
1	A	(untitled)	0	300	0	0	Traffic	
	B	(untitled)	0	300	0	0	Traffic	
	C	(untitled)	0	300	0	0	Traffic	
	D	(untitled)	0	5	0	0	Traffic	
	E	(untitled)	5	5	0	0	Pedestrian	0

Library Stages

Controller Stream	Library Stage	Phases in stage	User stage minimum (s)
1	1	A	1
	2	B	1
	3	C	1
	4	D	1
	5	E	1

Stage Sequences

Controller Stream	Sequence	Name	Multiple cycling	Stage IDs	Stage ends
1	1	(untitled)	Single	1, 2, 3, 4, 5	20, 72, 85, 92, 102

Intergreen Matrix for Controller Stream 1

		To				
		A	B	C	D	E
From	A		5	5	5	5
	B	5		5	5	5
	C	5	5		5	5
	D	5	5	5		5
	E	5	5	5	5	

Banned Stage transitions for Controller Stream 1

		To				
		1	2	3	4	5
From	1					
	2					
	3					
	4					
	5					

Interstage Matrix for Controller Stream 1

		To				
		1	2	3	4	5
From	1	0	5	5	5	5
	2	5	0	5	5	5
	3	5	5	0	5	5
	4	5	5	5	0	5
	5	5	5	5	5	0

Resultant Stages

Controller Stream	Resultant Stage	Is base stage	Library Stage ID	Phases in this stage	Stage start (s)	Stage end (s)	Stage duration (s)	User stage minimum (s)	Stage minimum (s)
1	1	✓	1	A	107	20	33	1	1
	2	✓	2	B	25	72	47	1	1
	3	✓	3	C	77	85	8	1	1
	4	✓	4	D	90	92	2	1	1
	5	✓	5	E	97	102	5	1	5

Resultant Phase Green Periods

Controller Stream	Phase	Green period	Is base green period	Start time (s)	End time (s)	Duration (s)
1	A	1	✓	107	20	33
	B	1	✓	25	72	47
	C	1	✓	77	85	8
	D	1	✓	90	92	2
	E	1	✓	97	102	5

Traffic Stream Green Times

Arm	Traffic Stream	Traffic Node	Controller Stream	Phase	Green Period 1		
					Start	End	Duration
A	1	1	1	B	25	72	47
B	1	1	1	C	77	85	8
C	1	1	1	A	107	20	33
C	2	1	1	A	107	20	33
D	1	1	1	D	90	92	2

Phase Timings Diagram for Controller Stream 1

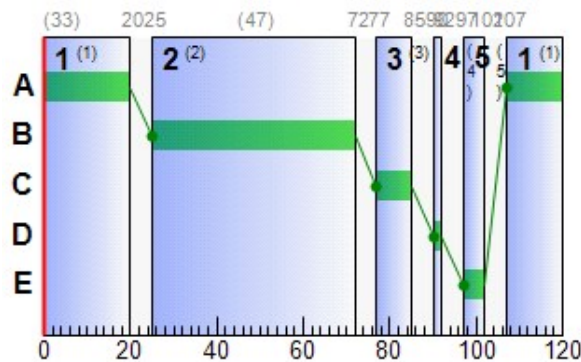

Stage Sequence Diagram for Controller Stream 1

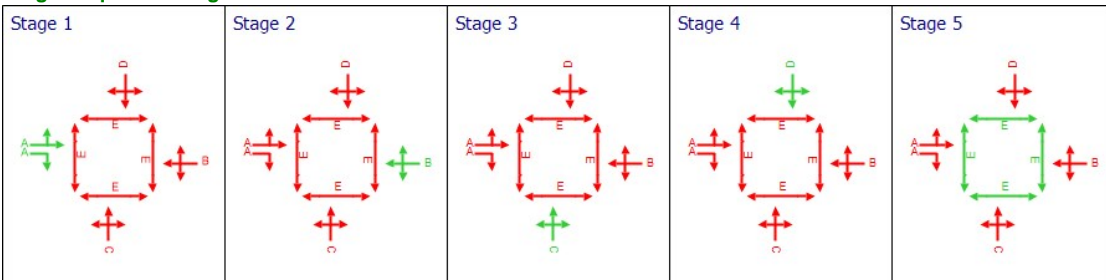

Resultant penalties

Time Segment	Controller stream	Phase min max penalty (£ per hr)	Intergreen broken penalty (£ per hr)	Stage constraint broken penalty (£ per hr)	Cost of controller stream penalties (£ per hr)
17:00-18:00	1	0.00	0.00	0.00	0.00

Traffic Stream Results

Traffic Stream Results: Vehicle summary

Time Segment	Arm	Traffic Stream	Degree of saturation (%)	Practical reserve capacity (%)	Calculated flow entering (Veh/hr)	Calculated sat flow (Veh/hr)	Actual green (s per cycle)	Mean Delay per Veh (s)	Mean max queue (Veh)	Utilised storage (%)	Weighted cost of delay (£ per hr)	Weighted cost of stops (£ per hr)	Performance Index (£ per hr)
17:00-18:00	A	1	72	39	519	1800	47	36.70	15.48	177.98	75.14	5.70	80.84
	Ax	1	0	Unrestricted	423	Unrestricted	120	0.00	0.00	0.00	0.00	0.00	0.00
	B	1	52	93	70	1800	8	67.46	2.51	28.85	18.63	0.93	19.56
	Bx	1	0	Unrestricted	63	Unrestricted	120	0.00	0.00	0.00	0.00	0.00	0.00
	C	1	75	34	381	1800	33	49.23	12.61	145.00	73.99	4.65	78.64
		2	3	3543	14	1800	33	31.27	0.33	3.85	1.73	0.12	1.85
	Cx	1	0	Unrestricted	486	Unrestricted	120	0.00	0.00	0.00	0.00	0.00	0.00
	D	1	47	114	21	1800	2	90.98	0.88	10.14	7.54	0.32	7.86
Dx	1	0	Unrestricted	33	Unrestricted	120	0.00	0.00	0.00	0.00	0.00	0.00	

Traffic Stream Results: Flows and signals

Time Segment	Arm	Traffic Stream	Calculated flow entering (Veh/hr)	Calculated flow out (Veh/hr)	Flow discrepancy (Veh/hr)	Adjusted flow warning	Calculated sat flow (Veh/hr)	Calculated capacity (Veh/hr)	Degree of saturation (%)	DOS Threshold exceeded	Practical reserve capacity (%)	Mean modulus of error	Actual green (s per cycle)
17:00-18:00	A	1	519	519	0		1800	720	72		39	0.00	47
	Ax	1	423	423	0		Unrestricted	Unrestricted	0		Unrestricted	1.10	120
	B	1	70	70	0		1800	135	52		93	0.00	8
	Bx	1	63	63	0		Unrestricted	Unrestricted	0		Unrestricted	0.86	120
	C	1	381	381	0		1800	510	75		34	0.00	33
		2	14	14	0		1800	510	3		3543	0.00	33
	Cx	1	486	486	0		Unrestricted	Unrestricted	0		Unrestricted	1.01	120
	D	1	21	21	0		1800	45	47		114	0.00	2
Dx	1	33	33	0		Unrestricted	Unrestricted	0		Unrestricted	0.73	120	

Traffic Stream Results: Stops and delays

Time Segment	Arm	Traffic Stream	Mean Cruise Time per Veh (s)	Mean Delay per Veh (s)	Uniform delay (Veh-hr/hr)	Random plus oversat delay (Veh-hr/hr)	Weighted cost of delay (£ per hr)	Mean stops per Veh (%)	Uniform stops (Stops per hr)	Random stops (Stops per hr)	Weighted cost of stops (£ per hr)
17:00-18:00	A	1	6.00	36.70	4.38	0.92	75.14	87.54	427.23	27.11	5.70
	Ax	1	16.50	0.00	0.00	0.00	0.00	0.00	0.00	0.00	0.00
	B	1	6.00	67.46	1.04	0.27	18.63	106.20	66.39	7.94	0.93
	Bx	1	16.59	0.00	0.00	0.00	0.00	0.00	0.00	0.00	0.00
	C	1	6.00	49.23	4.14	1.07	73.99	97.34	339.34	31.52	4.65
		2	6.00	31.27	0.12	0.00	1.73	70.76	9.90	0.01	0.12
	Cx	1	16.80	0.00	0.00	0.00	0.00	0.00	0.00	0.00	0.00
	D	1	6.00	90.98	0.34	0.19	7.54	123.18	20.44	5.42	0.32
Dx	1	16.45	0.00	0.00	0.00	0.00	0.00	0.00	0.00	0.00	

Traffic Stream Results: Queues and blocking

Time Segment	Arm	Traffic Stream	Initial queue (Veh)	Mean max queue (Veh)	Max queue storage (Veh)	Utilised storage (%)	Average storage excess queue (Veh)	Average limit excess queue (Veh)	Excess queue penalty (£ per hr)	Wasted time starvation (s (per cycle))	Wasted time blocking back (s (per cycle))	Wasted time total (s (per cycle))	Estimated blocking	
17:00-18:00	A	1	0.00	15.48	8.70	177.98	1.36	0.00	0.00	0.00	0.00	0.00		
	Ax	1	0.00	0.00	23.92	0.00	0.00	0.00	0.00	54.00	0.00	54.00		
	B	1	0.00	2.51	8.70	28.85	0.00	0.00	0.00	0.00	0.00	0.00		
	Bx	1	0.00	0.00	24.05	0.00	0.00	0.00	0.00	73.00	0.00	73.00		
	C	1	0.00	12.61	8.70	145.00	0.62	0.00	0.00	0.00	0.00	0.00	0.00	
		2	0.00	0.33	8.70	3.85	0.00	0.00	0.00	0.00	33.00	0.00	33.00	
	Cx	1	0.00	0.00	24.35	0.00	0.00	0.00	0.00	45.00	0.00	45.00		
	D	1	0.00	0.88	8.70	10.14	0.00	0.00	0.00	0.00	1.00	0.00	1.00	
Dx	1	0.00	0.00	23.84	0.00	0.00	0.00	0.00	0.00	98.00	0.00	98.00		

Pedestrian Crossing Results

Pedestrian Crossings: Pedestrian summary

Time Segment	Crossing	Side	Degree of saturation (%)	Calculated Flow Entering (Ped/hr)	Calculated sat flow (Ped/hr)	Actual green (s (per cycle))	Mean Delay Per Ped (s)	Mean max queue (Ped)	Weighted cost of delay (£ per hr)	Performance Index (£ per hr)
17:00-18:00	(ALL)	(ALL)	7	30	11000	5	55.58	0.96	6.58	6.58

Pedestrian Crossings: Flows and signals

Time Segment	Crossing	Side	Calculated flow entering (Ped/hr)	Calculated flow out (Ped/hr)	Flow discrepancy (Ped/hr)	Adjusted flow warning	Calculated sat flow (Ped/hr)	Calculated capacity (Ped/hr)	Degree of saturation (%)	DOS Threshold exceeded	Practical reserve capacity (%)	Mean modulus of error	Actual green (s (per cycle))
17:00-18:00	(ALL)	(ALL)	30	30	0		11000	458	7		1428	0.00	5

Pedestrian Crossings: Stops and delays

Time Segment	Crossing	Side	Mean Cruise Time per Ped (s)	Mean Delay per Ped (s)	Uniform delay (Ped-hr/hr)	Random plus oversat delay (Ped-hr/hr)	Weighted cost of delay (£ per hr)
17:00-18:00	1	1	5.67	55.58	0.46	0.00	6.58
		2	5.67	55.58	0.46	0.00	6.58
	2	1	6.33	55.58	0.46	0.00	6.58
		2	6.33	55.58	0.46	0.00	6.58
	3	1	6.33	55.58	0.46	0.00	6.58
		2	6.33	55.58	0.46	0.00	6.58
	4	1	5.67	55.58	0.46	0.00	6.58
		2	5.67	55.58	0.46	0.00	6.58

Pedestrian Crossings: Queues and blocking

Time Segment	Crossing	Side	Mean max queue (Ped)	Max queue storage (Ped)	Utilised storage (%)	Average storage excess queue (Ped)	Average limit excess queue (Ped)	Excess queue penalty (£ per hr)
17:00-18:00	(ALL)	(ALL)	0.96	10.00	9.58	0.00	0.00	0.00

Network Results

Network Results: Flows and signals

Time Segment	Calculated flow entering (Veh/hr)	Calculated flow out (Veh/hr)	Flow discrepancy (Veh/hr)	Adjusted flow warning	Degree of saturation (%)	DOS Threshold exceeded	Practical reserve capacity (%)	Actual green (s (per cycle))
17:00-18:00	2250	2250	0		75		34	643

Network Results: Stops and delays

Time Segment	Mean Cruise Time per Veh (s)	Mean Delay per Veh (s)	Uniform delay (Veh-hr/hr)	Random plus oversat delay (Veh-hr/hr)	Weighted cost of delay (£ per hr)	Mean stops per Veh (%)	Uniform stops (Stops per hr)	Random stops (Stops per hr)	Weighted cost of stops (£ per hr)
17:00-18:00	10.76	25.87	13.72	2.46	229.63	41.57	863.30	72.01	11.73

Network Results: Queues and blocking

Time Segment	Utilised storage (%)	Excess queue penalty (£ per hr)	Wasted time starvation (s per cycle))	Wasted time blocking back (s per cycle))	Wasted time total (s per cycle))
17:00-18:00	177.98	0.00	304.00	0.00	304.00

Final Prediction Table

Traffic Stream Results

Arm	Traffic Stream	Name	Traffic node	SIGNALS		FLOWS		PERFORMANCE				PER PCU			QUEUES
				Controller stream	Phase	Calculated flow entering (Veh/hr)	Calculated sat flow (Veh/hr)	Actual green (s per cycle))	Wasted time total (s per cycle))	Degree of saturation (%)	Practical reserve capacity (%)	JourneyTime (s)	Mean Delay per Veh (s)	Mean stops per Veh (%)	Mean max queue (Veh)
A	1	(untitled)	1	1	B	519 <	1800	47	0.00	72	39	42.70	36.70	87.54	15.48 +
Ax	1	(untitled)				423	Unrestricted	120	54.00	0	Unrestricted	16.50	0.00	0.00	0.00
B	1	(untitled)	1	1	C	70	1800	8	0.00	52	93	73.46	67.46	106.20	2.51
Bx	1	(untitled)				63	Unrestricted	120	73.00	0	Unrestricted	16.59	0.00	0.00	0.00
C	1	(untitled)	1	1	A	381 <	1800	33	0.00	75	34	55.23	49.23	97.34	12.61 +
	2	(untitled)	1	1	A	14	1800	33	33.00	3	3543	37.27	31.27	70.76	0.33
Cx	1	(untitled)				486	Unrestricted	120	45.00	0	Unrestricted	16.80	0.00	0.00	0.00
D	1	(untitled)	1	1	D	21	1800	2	1.00	47	114	96.98	90.98	123.18	0.88
Dx	1	(untitled)				33	Unrestricted	120	98.00	0	Unrestricted	16.45	0.00	0.00	0.00

Pedestrian Crossing Results

Pedestrian	Side	Name	Traffic node	SIGNALS		FLOWS		PERFORMANCE			PER PED		QUEUES	WEIGHTS	PEN
				Controller stream	Phase	Calculated Flow Entering (Ped/hr)	Calculated sat flow (Ped/hr)	Actual green (s per cycle))	Degree of saturation (%)	Practical reserve capacity (%)	JourneyTime (s)	Mean Delay per Ped (s)	Mean max queue (Ped)	Delay weighting (%)	Co tra pen (£ p
1	1	(untitled)	1	1	E	30	11000	5	7	1428	61.25	55.58	0.96	100	0
	2	(untitled)	1	1	E	30	11000	5	7	1428	61.25	55.58	0.96	100	0
2	1	(untitled)	1	1	E	30	11000	5	7	1428	61.92	55.58	0.96	100	0
	2	(untitled)	1	1	E	30	11000	5	7	1428	61.92	55.58	0.96	100	0
3	1	(untitled)	1	1	E	30	11000	5	7	1428	61.92	55.58	0.96	100	0
	2	(untitled)	1	1	E	30	11000	5	7	1428	61.92	55.58	0.96	100	0
4	1	(untitled)	1	1	E	30	11000	5	7	1428	61.25	55.58	0.96	100	0
	2	(untitled)	1	1	E	30	11000	5	7	1428	61.25	55.58	0.96	100	0

Network Results

	Distance travelled (PCU-km/hr)	Time spent (PCU-hr/hr)	Mean journey speed (kph)	Uniform delay (Veh-hr/hr)	Random plus oversat delay (Veh-hr/hr)	Weighted cost of delay (£ per hr)	Weighted cost of stops (£ per hr)	Excess queue penalty (£ per hr)	Performance Index (£ per hr)
Normal traffic	189.70	18.79	10.10	10.01	2.46	177.02	11.73	0.00	188.74
Bus	0.00	0.00	0.00	0.00	0.00	0.00	0.00	0.00	0.00
Tram	0.00	0.00	0.00	0.00	0.00	0.00	0.00	0.00	0.00
Pedestrians	2.04	4.11	0.50	3.71	0.00	52.62	0.00	0.00	52.62
TOTAL	191.74	22.89	8.37	13.72	2.46	229.63	11.73	0.00	241.36

- | < = adjusted flow warning (upstream links/traffic streams are over-saturated)
- | * = Traffic Stream - Normal, Bus or Tram Stop or Delay weighting has been set to a value other than 100%
- | ^ = Traffic Stream - Normal, Bus or Tram Stop or Delay Path weighting has been set to a value other than 100%
- | + = average link/traffic stream excess queue is greater than 0
- | **P.I. = PERFORMANCE INDEX**



Junctions 9

ARCADY 9 - Roundabout Module

Version: 9.5.1.7462
© Copyright TRL Limited, 2019

For sales and distribution information, program advice and maintenance, contact TRL:
+44 (0)1344 379777 software@trl.co.uk www.trlsoftware.co.uk

The users of this computer program for the solution of an engineering problem are in no way relieved of their responsibility for the correctness of the solution

Filename: Junction 5 - AM-PM.j9

Path: M:\Projects\12\12-081A - Dunshaughlin Phase 2 - Civils\Design\Traffic\Modelling AUGUST 2020\Junction 5

Report generation date: 19/08/2020 12:15:31

-
- »JUNCTION 5 - DO NOTHING 2024, AM
 - »JUNCTION 5 - DO NOTHING 2024, PM
 - »JUNCTION 5 - DO NOTHING 2029, AM
 - »JUNCTION 5 - DO NOTHING 2029, PM
 - »JUNCTION 5 - DO NOTHING 2039, AM
 - »JUNCTION 5 - DO NOTHING 2039, PM
 - »JUNCTION 5 - DO SOMETHING 2024, AM
 - »JUNCTION 5 - DO SOMETHING 2024, PM
 - »JUNCTION 5 - DO SOMETHING 2029, AM
 - »JUNCTION 5 - DO SOMETHING 2029, PM
 - »JUNCTION 5 - DO SOMETHING 2039, AM
 - »JUNCTION 5 - DO SOMETHING 2039, PM

Summary of junction performance

	AM					PM				
	Set ID	Queue (Veh)	Delay (s)	RFC	LOS	Set ID	Queue (Veh)	Delay (s)	RFC	LOS
JUNCTION 5 - DO NOTHING 2024										
Arm 1	D3	0.0	2.62	0.02	A	D4	0.0	2.52	0.01	A
Arm 2		0.3	2.59	0.22	A		0.3	2.62	0.24	A
Arm 3		0.0	0.00	0.00	A		0.0	0.00	0.00	A
Arm 4		0.3	2.62	0.22	A		0.2	2.51	0.18	A
JUNCTION 5 - DO NOTHING 2029										
Arm 1	D5	0.1	2.76	0.06	A	D6	0.1	2.84	0.11	A
Arm 2		0.4	2.84	0.30	A		0.4	2.86	0.30	A
Arm 3		0.0	0.00	0.00	A		0.0	0.00	0.00	A
Arm 4		0.4	2.86	0.26	A		0.3	2.67	0.22	A
JUNCTION 5 - DO NOTHING 2039										
Arm 1	D7	0.1	2.80	0.06	A	D8	0.1	2.88	0.12	A
Arm 2		0.5	2.91	0.31	A		0.5	2.94	0.31	A
Arm 3		0.0	0.00	0.00	A		0.0	0.00	0.00	A
Arm 4		0.4	2.93	0.28	A		0.3	2.72	0.23	A
JUNCTION 5 - DO SOMETHING 2024										
Arm 1	D9	0.1	2.88	0.08	A	D10	0.0	2.62	0.04	A
Arm 2		0.4	2.73	0.26	A		0.4	2.80	0.29	A
Arm 3		0.0	0.00	0.00	A		0.0	0.00	0.00	A
Arm 4		0.4	2.81	0.27	A		0.3	2.63	0.21	A
JUNCTION 5 - DO SOMETHING 2029										
Arm 1	D11	0.1	3.04	0.12	A	D12	0.2	2.97	0.14	A
Arm 2		0.5	3.01	0.33	A		0.5	3.08	0.35	A
Arm 3		0.0	0.00	0.00	A		0.0	0.00	0.00	A
Arm 4		0.4	3.09	0.31	A		0.3	2.80	0.24	A
JUNCTION 5 - DO SOMETHING 2039										
Arm 1	D13	0.1	3.10	0.12	A	D14	0.2	3.01	0.14	A
Arm 2		0.5	3.10	0.35	A		0.6	3.17	0.36	A
Arm 3		0.0	0.00	0.00	A		0.0	0.00	0.00	A
Arm 4		0.5	3.17	0.33	A		0.3	2.86	0.26	A

Values shown are the highest values encountered over all time segments. Delay is the maximum value of average delay per arriving vehicle.

File summary

File Description

Title	
Location	
Site number	
Date	04/03/2020
Version	
Status	(new file)
Identifier	
Client	
Jobnumber	
Enumerator	DOMAINf.silva
Description	

Units

Distance units	Speed units	Traffic units input	Traffic units results	Flow units	Average delay units	Total delay units	Rate of delay units
m	kph	Veh	Veh	perHour	s	-Min	perMin

Analysis Options

Calculate Queue Percentiles	Calculate residual capacity	RFC Threshold	Average Delay threshold (s)	Queue threshold (PCU)
		0.85	36.00	20.00

Demand Set Summary

ID	Scenario name	Time Period name	Traffic profile type	Start time (HH:mm)	Finish time (HH:mm)	Time segment length (min)	Single time segment only
D3	DO NOTHING 2024	AM	FLAT	08:00	09:00	60	✓
D4	DO NOTHING 2024	PM	FLAT	17:00	18:00	60	✓
D5	DO NOTHING 2029	AM	FLAT	08:00	09:00	60	✓
D6	DO NOTHING 2029	PM	FLAT	17:00	18:00	60	✓
D7	DO NOTHING 2039	AM	FLAT	08:00	09:00	60	✓
D8	DO NOTHING 2039	PM	FLAT	17:00	18:00	60	✓
D9	DO SOMETHING 2024	AM	FLAT	08:00	09:00	60	✓
D10	DO SOMETHING 2024	PM	FLAT	17:00	18:00	60	✓
D11	DO SOMETHING 2029	AM	FLAT	08:00	09:00	60	✓
D12	DO SOMETHING 2029	PM	FLAT	17:00	18:00	60	✓
D13	DO SOMETHING 2039	AM	FLAT	08:00	09:00	60	✓
D14	DO SOMETHING 2039	PM	FLAT	17:00	18:00	60	✓

Analysis Set Details

ID	Name	Network flow scaling factor (%)
A1	JUNCTION 5	100.000

JUNCTION 5 - DO NOTHING 2024, AM

Data Errors and Warnings

No errors or warnings

Junction Network

Junctions

Junction	Name	Junction type	Use circulating lanes	Arm order	Junction Delay (s)	Junction LOS
1	untitled	Standard Roundabout		1, 2, 3, 4	2.61	A

Junction Network Options

Driving side	Lighting
Left	Normal/unknown

Arms

Arms

Arm	Name	Description
1	Phase 1 and 2 Site Access Road (E)	
2	R125 (S)	
3	Minor Western Arm	
4	R125 (N)	

Roundabout Geometry

Arm	V - Approach road half-width (m)	E - Entry width (m)	I' - Effective flare length (m)	R - Entry radius (m)	D - Inscribed circle diameter (m)	PHI - Conflict (entry) angle (deg)	Exit only
1	3.50	6.00	20.0	36.5	50.0	27.7	
2	3.80	7.00	25.0	25.0	50.0	26.2	
3	3.50	6.00	20.0	36.5	50.0	27.7	
4	3.70	7.20	25.0	25.3	50.0	32.1	

Slope / Intercept / Capacity

Roundabout Slope and Intercept used in model

Arm	Final slope	Final intercept (PCU/hr)
1	0.608	1650
2	0.649	1881
3	0.608	1650
4	0.639	1859

The slope and intercept shown above include any corrections and adjustments.

Traffic Demand

Demand Set Details

ID	Scenario name	Time Period name	Traffic profile type	Start time (HH:mm)	Finish time (HH:mm)	Time segment length (min)	Single time segment only
D3	DO NOTHING 2024	AM	FLAT	08:00	09:00	60	✓

Vehicle mix source	PCU Factor for a HV (PCU)
HV Percentages	2.00

Demand overview (Traffic)

Arm	Linked arm	Use O-D data	Average Demand (Veh/hr)	Scaling Factor (%)
1		✓	31	100.000
2		✓	400	100.000
3		✓	0	100.000
4		✓	390	100.000

Origin-Destination Data

Demand (Veh/hr)

		To			
		1	2	3	4
From	1	0	25	0	6
	2	16	0	0	384
	3	0	0	0	0
	4	4	386	0	0

Vehicle Mix

Heavy Vehicle Percentages

		To			
		1	2	3	4
From	1	0	0	0	0
	2	0	0	0	5
	3	0	0	0	0
	4	0	5	0	0

Results

Results Summary for whole modelled period

Arm	Max RFC	Max Delay (s)	Max Queue (Veh)	Max LOS
1	0.02	2.62	0.0	A
2	0.22	2.59	0.3	A
3	0.00	0.00	0.0	A
4	0.22	2.62	0.3	A

Main Results for each time segment

08:00 - 09:00

Arm	Total Demand (Veh/hr)	Circulating flow (Veh/hr)	Capacity (Veh/hr)	RFC	Throughput (Veh/hr)	End queue (Veh)	Delay (s)	Unsignalised level of service
1	31	386	1403	0.022	31	0.0	2.622	A
2	400	6	1791	0.223	400	0.3	2.586	A
3	0	406	1391	0.000	0	0.0	0.000	A
4	390	16	1761	0.221	390	0.3	2.624	A

JUNCTION 5 - DO NOTHING 2024, PM

Data Errors and Warnings

No errors or warnings

Junction Network

Junctions

Junction	Name	Junction type	Use circulating lanes	Arm order	Junction Delay (s)	Junction LOS
1	untitled	Standard Roundabout		1, 2, 3, 4	2.57	A

Junction Network Options

Driving side	Lighting
Left	Normal/unknown

Traffic Demand

Demand Set Details

ID	Scenario name	Time Period name	Traffic profile type	Start time (HH:mm)	Finish time (HH:mm)	Time segment length (min)	Single time segment only
D4	DO NOTHING 2024	PM	FLAT	17:00	18:00	60	✓

Vehicle mix source	PCU Factor for a HV (PCU)
HV Percentages	2.00

Demand overview (Traffic)

Arm	Linked arm	Use O-D data	Average Demand (Veh/hr)	Scaling Factor (%)
1		✓	20	100.000
2		✓	422	100.000
3		✓	0	100.000
4		✓	324	100.000

Origin-Destination Data

Demand (Veh/hr)

		To			
		1	2	3	4
From	1	0	16	0	4
	2	22	0	0	400
	3	0	0	0	0
	4	6	318	0	0

Vehicle Mix

Heavy Vehicle Percentages

		To			
		1	2	3	4
From	1	0	0	0	0
	2	0	0	0	5
	3	0	0	0	0
	4	0	5	0	0

Results

Results Summary for whole modelled period

Arm	Max RFC	Max Delay (s)	Max Queue (Veh)	Max LOS
1	0.01	2.52	0.0	A
2	0.24	2.62	0.3	A
3	0.00	0.00	0.0	A
4	0.18	2.51	0.2	A

Main Results for each time segment

17:00 - 18:00

Arm	Total Demand (Veh/hr)	Circulating flow (Veh/hr)	Capacity (Veh/hr)	RFC	Throughput (Veh/hr)	End queue (Veh)	Delay (s)	Unsignalised level of service
1	20	318	1447	0.014	20	0.0	2.522	A
2	422	4	1794	0.235	422	0.3	2.623	A
3	0	426	1379	0.000	0	0.0	0.000	A
4	324	22	1758	0.184	324	0.2	2.509	A

JUNCTION 5 - DO NOTHING 2029, AM

Data Errors and Warnings

No errors or warnings

Junction Network

Junctions

Junction	Name	Junction type	Use circulating lanes	Arm order	Junction Delay (s)	Junction LOS
1	untitled	Standard Roundabout		1, 2, 3, 4	2.84	A

Junction Network Options

Driving side	Lighting
Left	Normal/unknown

Traffic Demand

Demand Set Details

ID	Scenario name	Time Period name	Traffic profile type	Start time (HH:mm)	Finish time (HH:mm)	Time segment length (min)	Single time segment only
D5	DO NOTHING 2029	AM	FLAT	08:00	09:00	60	✓

Vehicle mix source	PCU Factor for a HV (PCU)
HV Percentages	2.00

Demand overview (Traffic)

Arm	Linked arm	Use O-D data	Average Demand (Veh/hr)	Scaling Factor (%)
1		✓	77	100.000
2		✓	533	100.000
3		✓	0	100.000
4		✓	448	100.000

Origin-Destination Data

Demand (Veh/hr)

		To			
		1	2	3	4
From	1	0	62	0	15
	2	115	0	0	418
	3	0	0	0	0
	4	29	419	0	0

Vehicle Mix

Heavy Vehicle Percentages

		To			
		1	2	3	4
From	1	0	0	0	0
	2	0	0	0	5
	3	0	0	0	0
	4	0	5	0	0

Results

Results Summary for whole modelled period

Arm	Max RFC	Max Delay (s)	Max Queue (Veh)	Max LOS
1	0.06	2.76	0.1	A
2	0.30	2.84	0.4	A
3	0.00	0.00	0.0	A
4	0.26	2.86	0.4	A

Main Results for each time segment

08:00 - 09:00

Arm	Total Demand (Veh/hr)	Circulating flow (Veh/hr)	Capacity (Veh/hr)	RFC	Throughput (Veh/hr)	End queue (Veh)	Delay (s)	Unsignalised level of service
1	77	419	1382	0.056	77	0.1	2.757	A
2	533	15	1801	0.296	533	0.4	2.838	A
3	0	548	1304	0.000	0	0.0	0.000	A
4	448	115	1706	0.263	448	0.4	2.862	A

JUNCTION 5 - DO NOTHING 2029, PM

Data Errors and Warnings

No errors or warnings

Junction Network

Junctions

Junction	Name	Junction type	Use circulating lanes	Arm order	Junction Delay (s)	Junction LOS
1	untitled	Standard Roundabout		1, 2, 3, 4	2.79	A

Junction Network Options

Driving side	Lighting
Left	Normal/unknown

Traffic Demand

Demand Set Details

ID	Scenario name	Time Period name	Traffic profile type	Start time (HH:mm)	Finish time (HH:mm)	Time segment length (min)	Single time segment only
D6	DO NOTHING 2029	PM	FLAT	17:00	18:00	60	✓

Vehicle mix source	PCU Factor for a HV (PCU)
HV Percentages	2.00

Demand overview (Traffic)

Arm	Linked arm	Use O-D data	Average Demand (Veh/hr)	Scaling Factor (%)
1		✓	163	100.000
2		✓	530	100.000
3		✓	0	100.000
4		✓	370	100.000

Origin-Destination Data

Demand (Veh/hr)

		To			
		1	2	3	4
From	1	0	130	0	33
	2	95	0	0	435
	3	0	0	0	0
	4	24	346	0	0

Vehicle Mix

Heavy Vehicle Percentages

		To			
		1	2	3	4
From	1	0	0	0	0
	2	0	0	0	5
	3	0	0	0	0
	4	0	5	0	0

Results

Results Summary for whole modelled period

Arm	Max RFC	Max Delay (s)	Max Queue (Veh)	Max LOS
1	0.11	2.84	0.1	A
2	0.30	2.86	0.4	A
3	0.00	0.00	0.0	A
4	0.22	2.67	0.3	A

Main Results for each time segment

17:00 - 18:00

Arm	Total Demand (Veh/hr)	Circulating flow (Veh/hr)	Capacity (Veh/hr)	RFC	Throughput (Veh/hr)	End queue (Veh)	Delay (s)	Unsignalised level of service
1	163	346	1429	0.114	163	0.1	2.843	A
2	530	33	1787	0.297	530	0.4	2.864	A
3	0	563	1295	0.000	0	0.0	0.000	A
4	370	95	1718	0.215	370	0.3	2.670	A

JUNCTION 5 - DO NOTHING 2039, AM

Data Errors and Warnings

No errors or warnings

Junction Network

Junctions

Junction	Name	Junction type	Use circulating lanes	Arm order	Junction Delay (s)	Junction LOS
1	untitled	Standard Roundabout		1, 2, 3, 4	2.91	A

Junction Network Options

Driving side	Lighting
Left	Normal/unknown

Traffic Demand

Demand Set Details

ID	Scenario name	Time Period name	Traffic profile type	Start time (HH:mm)	Finish time (HH:mm)	Time segment length (min)	Single time segment only
D7	DO NOTHING 2039	AM	FLAT	08:00	09:00	60	✓

Vehicle mix source	PCU Factor for a HV (PCU)
HV Percentages	2.00

Demand overview (Traffic)

Arm	Linked arm	Use O-D data	Average Demand (Veh/hr)	Scaling Factor (%)
1		✓	77	100.000
2		✓	564	100.000
3		✓	0	100.000
4		✓	479	100.000

Origin-Destination Data

Demand (Veh/hr)

		To			
		1	2	3	4
From	1	0	62	0	15
	2	115	0	0	449
	3	0	0	0	0
	4	29	450	0	0

Vehicle Mix

Heavy Vehicle Percentages

		To			
		1	2	3	4
From	1	0	0	0	0
	2	0	0	0	5
	3	0	0	0	0
	4	0	5	0	0

Results

Results Summary for whole modelled period

Arm	Max RFC	Max Delay (s)	Max Queue (Veh)	Max LOS
1	0.06	2.80	0.1	A
2	0.31	2.91	0.5	A
3	0.00	0.00	0.0	A
4	0.28	2.93	0.4	A

Main Results for each time segment

08:00 - 09:00

Arm	Total Demand (Veh/hr)	Circulating flow (Veh/hr)	Capacity (Veh/hr)	RFC	Throughput (Veh/hr)	End queue (Veh)	Delay (s)	Unsignalised level of service
1	77	450	1363	0.057	77	0.1	2.799	A
2	564	15	1800	0.313	564	0.5	2.912	A
3	0	579	1284	0.000	0	0.0	0.000	A
4	479	115	1705	0.281	479	0.4	2.935	A

JUNCTION 5 - DO NOTHING 2039, PM

Data Errors and Warnings

No errors or warnings

Junction Network

Junctions

Junction	Name	Junction type	Use circulating lanes	Arm order	Junction Delay (s)	Junction LOS
1	untitled	Standard Roundabout		1, 2, 3, 4	2.85	A

Junction Network Options

Driving side	Lighting
Left	Normal/unknown

Traffic Demand

Demand Set Details

ID	Scenario name	Time Period name	Traffic profile type	Start time (HH:mm)	Finish time (HH:mm)	Time segment length (min)	Single time segment only
D8	DO NOTHING 2039	PM	FLAT	17:00	18:00	60	✓

Vehicle mix source	PCU Factor for a HV (PCU)
HV Percentages	2.00

Demand overview (Traffic)

Arm	Linked arm	Use O-D data	Average Demand (Veh/hr)	Scaling Factor (%)
1		✓	163	100.000
2		✓	562	100.000
3		✓	0	100.000
4		✓	395	100.000

Origin-Destination Data

Demand (Veh/hr)

		To			
		1	2	3	4
From	1	0	130	0	33
	2	95	0	0	467
	3	0	0	0	0
	4	24	371	0	0

Vehicle Mix

Heavy Vehicle Percentages

		To			
		1	2	3	4
From	1	0	0	0	0
	2	0	0	0	5
	3	0	0	0	0
	4	0	5	0	0

Results

Results Summary for whole modelled period

Arm	Max RFC	Max Delay (s)	Max Queue (Veh)	Max LOS
1	0.12	2.88	0.1	A
2	0.31	2.94	0.5	A
3	0.00	0.00	0.0	A
4	0.23	2.72	0.3	A

Main Results for each time segment

17:00 - 18:00

Arm	Total Demand (Veh/hr)	Circulating flow (Veh/hr)	Capacity (Veh/hr)	RFC	Throughput (Veh/hr)	End queue (Veh)	Delay (s)	Unsignalised level of service
1	163	371	1413	0.115	163	0.1	2.879	A
2	562	33	1786	0.315	562	0.5	2.941	A
3	0	595	1274	0.000	0	0.0	0.000	A
4	395	95	1717	0.230	395	0.3	2.721	A

JUNCTION 5 - DO SOMETHING 2024, AM

Data Errors and Warnings

No errors or warnings

Junction Network

Junctions

Junction	Name	Junction type	Use circulating lanes	Arm order	Junction Delay (s)	Junction LOS
1	untitled	Standard Roundabout		1, 2, 3, 4	2.78	A

Junction Network Options

Driving side	Lighting
Left	Normal/unknown

Traffic Demand

Demand Set Details

ID	Scenario name	Time Period name	Traffic profile type	Start time (HH:mm)	Finish time (HH:mm)	Time segment length (min)	Single time segment only
D9	DO SOMETHING 2024	AM	FLAT	08:00	09:00	60	✓

Vehicle mix source	PCU Factor for a HV (PCU)
HV Percentages	2.00

Demand overview (Traffic)

Arm	Linked arm	Use O-D data	Average Demand (Veh/hr)	Scaling Factor (%)
1		✓	113	100.000
2		✓	467	100.000
3		✓	0	100.000
4		✓	462	100.000

Origin-Destination Data

Demand (Veh/hr)

		To			
		1	2	3	4
From	1	0	90	0	23
	2	50	0	0	417
	3	0	0	0	0
	4	12	450	0	0

Vehicle Mix

Heavy Vehicle Percentages

		To			
		1	2	3	4
From	1	0	0	0	0
	2	0	0	0	5
	3	0	0	0	0
	4	0	5	0	0

Results

Results Summary for whole modelled period

Arm	Max RFC	Max Delay (s)	Max Queue (Veh)	Max LOS
1	0.08	2.88	0.1	A
2	0.26	2.73	0.4	A
3	0.00	0.00	0.0	A
4	0.27	2.81	0.4	A

Main Results for each time segment

08:00 - 09:00

Arm	Total Demand (Veh/hr)	Circulating flow (Veh/hr)	Capacity (Veh/hr)	RFC	Throughput (Veh/hr)	End queue (Veh)	Delay (s)	Unsignalised level of service
1	113	450	1363	0.083	113	0.1	2.880	A
2	467	23	1787	0.261	467	0.4	2.727	A
3	0	490	1339	0.000	0	0.0	0.000	A
4	462	50	1742	0.265	462	0.4	2.811	A

JUNCTION 5 - DO SOMETHING 2024, PM

Data Errors and Warnings

No errors or warnings

Junction Network

Junctions

Junction	Name	Junction type	Use circulating lanes	Arm order	Junction Delay (s)	Junction LOS
1	untitled	Standard Roundabout		1, 2, 3, 4	2.72	A

Junction Network Options

Driving side	Lighting
Left	Normal/unknown

Traffic Demand

Demand Set Details

ID	Scenario name	Time Period name	Traffic profile type	Start time (HH:mm)	Finish time (HH:mm)	Time segment length (min)	Single time segment only
D10	DO SOMETHING 2024	PM	FLAT	17:00	18:00	60	✓

Vehicle mix source	PCU Factor for a HV (PCU)
HV Percentages	2.00

Demand overview (Traffic)

Arm	Linked arm	Use O-D data	Average Demand (Veh/hr)	Scaling Factor (%)
1		✓	57	100.000
2		✓	512	100.000
3		✓	0	100.000
4		✓	362	100.000

Origin-Destination Data

Demand (Veh/hr)

		To			
		1	2	3	4
From	1	0	46	0	11
	2	68	0	0	444
	3	0	0	0	0
	4	17	345	0	0

Vehicle Mix

Heavy Vehicle Percentages

		To			
		1	2	3	4
From	1	0	0	0	0
	2	0	0	0	5
	3	0	0	0	0
	4	0	5	0	0

Results

Results Summary for whole modelled period

Arm	Max RFC	Max Delay (s)	Max Queue (Veh)	Max LOS
1	0.04	2.62	0.0	A
2	0.29	2.80	0.4	A
3	0.00	0.00	0.0	A
4	0.21	2.63	0.3	A

Main Results for each time segment

17:00 - 18:00

Arm	Total Demand (Veh/hr)	Circulating flow (Veh/hr)	Capacity (Veh/hr)	RFC	Throughput (Veh/hr)	End queue (Veh)	Delay (s)	Unsignalised level of service
1	57	345	1430	0.040	57	0.0	2.622	A
2	512	11	1796	0.285	512	0.4	2.802	A
3	0	523	1319	0.000	0	0.0	0.000	A
4	362	68	1733	0.209	362	0.3	2.625	A

JUNCTION 5 - DO SOMETHING 2029, AM

Data Errors and Warnings

No errors or warnings

Junction Network

Junctions

Junction	Name	Junction type	Use circulating lanes	Arm order	Junction Delay (s)	Junction LOS
1	untitled	Standard Roundabout		1, 2, 3, 4	3.05	A

Junction Network Options

Driving side	Lighting
Left	Normal/unknown

Traffic Demand

Demand Set Details

ID	Scenario name	Time Period name	Traffic profile type	Start time (HH:mm)	Finish time (HH:mm)	Time segment length (min)	Single time segment only
D11	DO SOMETHING 2029	AM	FLAT	08:00	09:00	60	✓

Vehicle mix source	PCU Factor for a HV (PCU)
HV Percentages	2.00

Demand overview (Traffic)

Arm	Linked arm	Use O-D data	Average Demand (Veh/hr)	Scaling Factor (%)
1		✓	159	100.000
2		✓	600	100.000
3		✓	0	100.000
4		✓	521	100.000

Origin-Destination Data

Demand (Veh/hr)

		To			
		1	2	3	4
From	1	0	127	0	32
	2	149	0	0	451
	3	0	0	0	0
	4	37	484	0	0

Vehicle Mix

Heavy Vehicle Percentages

		To			
		1	2	3	4
From	1	0	0	0	0
	2	0	0	0	5
	3	0	0	0	0
	4	0	5	0	0

Results

Results Summary for whole modelled period

Arm	Max RFC	Max Delay (s)	Max Queue (Veh)	Max LOS
1	0.12	3.04	0.1	A
2	0.33	3.01	0.5	A
3	0.00	0.00	0.0	A
4	0.31	3.09	0.4	A

Main Results for each time segment

08:00 - 09:00

Arm	Total Demand (Veh/hr)	Circulating flow (Veh/hr)	Capacity (Veh/hr)	RFC	Throughput (Veh/hr)	End queue (Veh)	Delay (s)	Unsignalised level of service
1	159	484	1341	0.119	159	0.1	3.044	A
2	600	32	1793	0.335	599	0.5	3.014	A
3	0	631	1252	0.000	0	0.0	0.000	A
4	521	149	1685	0.309	521	0.4	3.091	A

JUNCTION 5 - DO SOMETHING 2029, PM

Data Errors and Warnings

No errors or warnings

Junction Network

Junctions

Junction	Name	Junction type	Use circulating lanes	Arm order	Junction Delay (s)	Junction LOS
1	untitled	Standard Roundabout		1, 2, 3, 4	2.97	A

Junction Network Options

Driving side	Lighting
Left	Normal/unknown

Traffic Demand

Demand Set Details

ID	Scenario name	Time Period name	Traffic profile type	Start time (HH:mm)	Finish time (HH:mm)	Time segment length (min)	Single time segment only
D12	DO SOMETHING 2029	PM	FLAT	17:00	18:00	60	✓

Vehicle mix source	PCU Factor for a HV (PCU)
HV Percentages	2.00

Demand overview (Traffic)

Arm	Linked arm	Use O-D data	Average Demand (Veh/hr)	Scaling Factor (%)
1		✓	200	100.000
2		✓	620	100.000
3		✓	0	100.000
4		✓	408	100.000

Origin-Destination Data

Demand (Veh/hr)

		To			
		1	2	3	4
From	1	0	160	0	40
	2	141	0	0	479
	3	0	0	0	0
	4	35	373	0	0

Vehicle Mix

Heavy Vehicle Percentages

		To			
		1	2	3	4
From	1	0	0	0	0
	2	0	0	0	5
	3	0	0	0	0
	4	0	5	0	0

Results

Results Summary for whole modelled period

Arm	Max RFC	Max Delay (s)	Max Queue (Veh)	Max LOS
1	0.14	2.97	0.2	A
2	0.35	3.08	0.5	A
3	0.00	0.00	0.0	A
4	0.24	2.80	0.3	A

Main Results for each time segment

17:00 - 18:00

Arm	Total Demand (Veh/hr)	Circulating flow (Veh/hr)	Capacity (Veh/hr)	RFC	Throughput (Veh/hr)	End queue (Veh)	Delay (s)	Unsignalised level of service
1	200	373	1412	0.142	200	0.2	2.970	A
2	620	40	1786	0.347	619	0.5	3.083	A
3	0	659	1234	0.000	0	0.0	0.000	A
4	408	141	1691	0.241	408	0.3	2.804	A

JUNCTION 5 - DO SOMETHING 2039, AM

Data Errors and Warnings

No errors or warnings

Junction Network

Junctions

Junction	Name	Junction type	Use circulating lanes	Arm order	Junction Delay (s)	Junction LOS
1	untitled	Standard Roundabout		1, 2, 3, 4	3.13	A

Junction Network Options

Driving side	Lighting
Left	Normal/unknown

Traffic Demand

Demand Set Details

ID	Scenario name	Time Period name	Traffic profile type	Start time (HH:mm)	Finish time (HH:mm)	Time segment length (min)	Single time segment only
D13	DO SOMETHING 2039	AM	FLAT	08:00	09:00	60	✓

Vehicle mix source	PCU Factor for a HV (PCU)
HV Percentages	2.00

Demand overview (Traffic)

Arm	Linked arm	Use O-D data	Average Demand (Veh/hr)	Scaling Factor (%)
1		✓	159	100.000
2		✓	631	100.000
3		✓	0	100.000
4		✓	552	100.000

Origin-Destination Data

Demand (Veh/hr)

		To			
		1	2	3	4
From	1	0	127	0	32
	2	149	0	0	482
	3	0	0	0	0
	4	37	515	0	0

Vehicle Mix

Heavy Vehicle Percentages

		To			
		1	2	3	4
From	1	0	0	0	0
	2	0	0	0	5
	3	0	0	0	0
	4	0	5	0	0

Results

Results Summary for whole modelled period

Arm	Max RFC	Max Delay (s)	Max Queue (Veh)	Max LOS
1	0.12	3.10	0.1	A
2	0.35	3.10	0.5	A
3	0.00	0.00	0.0	A
4	0.33	3.17	0.5	A

Main Results for each time segment

08:00 - 09:00

Arm	Total Demand (Veh/hr)	Circulating flow (Veh/hr)	Capacity (Veh/hr)	RFC	Throughput (Veh/hr)	End queue (Veh)	Delay (s)	Unsignalised level of service
1	159	515	1321	0.120	159	0.1	3.096	A
2	631	32	1792	0.352	630	0.5	3.097	A
3	0	662	1232	0.000	0	0.0	0.000	A
4	552	149	1685	0.328	552	0.5	3.174	A

JUNCTION 5 - DO SOMETHING 2039, PM

Data Errors and Warnings

No errors or warnings

Junction Network

Junctions

Junction	Name	Junction type	Use circulating lanes	Arm order	Junction Delay (s)	Junction LOS
1	untitled	Standard Roundabout		1, 2, 3, 4	3.04	A

Junction Network Options

Driving side	Lighting
Left	Normal/unknown

Traffic Demand

Demand Set Details

ID	Scenario name	Time Period name	Traffic profile type	Start time (HH:mm)	Finish time (HH:mm)	Time segment length (min)	Single time segment only
D14	DO SOMETHING 2039	PM	FLAT	17:00	18:00	60	✓

Vehicle mix source	PCU Factor for a HV (PCU)
HV Percentages	2.00

Demand overview (Traffic)

Arm	Linked arm	Use O-D data	Average Demand (Veh/hr)	Scaling Factor (%)
1		✓	200	100.000
2		✓	651	100.000
3		✓	0	100.000
4		✓	433	100.000

Origin-Destination Data

Demand (Veh/hr)

		To			
		1	2	3	4
From	1	0	160	0	40
	2	141	0	0	510
	3	0	0	0	0
	4	35	398	0	0

Vehicle Mix

Heavy Vehicle Percentages

		To			
		1	2	3	4
From	1	0	0	0	0
	2	0	0	0	5
	3	0	0	0	0
	4	0	5	0	0

Results

Results Summary for whole modelled period

Arm	Max RFC	Max Delay (s)	Max Queue (Veh)	Max LOS
1	0.14	3.01	0.2	A
2	0.36	3.17	0.6	A
3	0.00	0.00	0.0	A
4	0.26	2.86	0.3	A

Main Results for each time segment

17:00 - 18:00

Arm	Total Demand (Veh/hr)	Circulating flow (Veh/hr)	Capacity (Veh/hr)	RFC	Throughput (Veh/hr)	End queue (Veh)	Delay (s)	Unsignalised level of service
1	200	398	1396	0.143	200	0.2	3.009	A
2	651	40	1785	0.365	650	0.6	3.170	A
3	0	690	1215	0.000	0	0.0	0.000	A
4	433	141	1691	0.256	433	0.3	2.861	A

Junctions 9
PICADY 9 - Priority Intersection Module
Version: 9.5.1.7462 © Copyright TRL Limited, 2019
For sales and distribution information, program advice and maintenance, contact TRL: +44 (0)1344 379777 software@trl.co.uk www.trlsoftware.co.uk
The users of this computer program for the solution of an engineering problem are in no way relieved of their responsibility for the correctness of the solution

Filename: Junction 6 AM-PM.j9
Path: M:\Projects\12\12-081A - Dunshaughlin Phase 2 - Civils\Design\Traffic\Modelling AUGUST 2020\Junction 6
Report generation date: 19/08/2020 12:16:25

- »JUNCTION 6 - DO SOMETHING 2024, AM
- »JUNCTION 6 - DO SOMETHING 2024, PM
- »JUNCTION 6 - DO SOMETHING 2029, AM
- »JUNCTION 6 - DO SOMETHING 2029, PM
- »JUNCTION 6 - DO SOMETHING 2039, AM
- »JUNCTION 6 - DO SOMETHING 2039, PM

Summary of junction performance

	AM					PM				
	Set ID	Queue (Veh)	Delay (s)	RFC	LOS	Set ID	Queue (Veh)	Delay (s)	RFC	LOS
JUNCTION 6 - DO SOMETHING 2024										
Stream B-AC	D1	0.2	7.25	0.15	A	D2	0.1	6.30	0.05	A
Stream C-AB		0.1	5.93	0.06	A		0.1	5.67	0.10	A
JUNCTION 6 - DO SOMETHING 2029										
Stream B-AC	D3	0.2	7.32	0.15	A	D4	0.1	6.33	0.05	A
Stream C-AB		0.1	5.93	0.06	A		0.2	5.60	0.10	A
JUNCTION 6 - DO SOMETHING 2039										
Stream B-AC	D5	0.2	7.37	0.15	A	D6	0.1	6.34	0.05	A
Stream C-AB		0.1	5.91	0.07	A		0.2	5.56	0.10	A

Values shown are the highest values encountered over all time segments. Delay is the maximum value of average delay per arriving vehicle.

File summary

File Description

Title	
Location	
Site number	
Date	22/07/2020
Version	
Status	(new file)
Identifier	
Client	
Jobnumber	
Enumerator	DOMAINf.silva
Description	

Units

Distance units	Speed units	Traffic units input	Traffic units results	Flow units	Average delay units	Total delay units	Rate of delay units
m	kph	Veh	Veh	perHour	s	-Min	perMin

Analysis Options

Calculate Queue Percentiles	Calculate residual capacity	RFC Threshold	Average Delay threshold (s)	Queue threshold (PCU)
		0.85	36.00	20.00

Demand Set Summary

ID	Scenario name	Time Period name	Traffic profile type	Start time (HH:mm)	Finish time (HH:mm)	Time segment length (min)	Single time segment only
D1	DO SOMETHING 2024	AM	FLAT	08:00	09:00	60	✓
D2	DO SOMETHING 2024	PM	FLAT	17:00	18:00	60	✓
D3	DO SOMETHING 2029	AM	FLAT	08:00	09:00	60	✓
D4	DO SOMETHING 2029	PM	FLAT	17:00	18:00	60	✓
D5	DO SOMETHING 2039	AM	FLAT	08:00	09:00	60	✓
D6	DO SOMETHING 2039	PM	FLAT	17:00	18:00	60	✓

Analysis Set Details

ID	Name	Network flow scaling factor (%)
A1	JUNCTION 6	100.000

JUNCTION 6 - DO SOMETHING 2024, AM

Data Errors and Warnings

No errors or warnings

Junction Network

Junctions

Junction	Name	Junction type	Major road direction	Use circulating lanes	Junction Delay (s)	Junction LOS
1	untitled	T-Junction	Two-way		2.33	A

Junction Network Options

Driving side	Lighting
Left	Normal/unknown

Arms

Arms

Arm	Name	Description	Arm type
A	L2208 (W)		Major
B	Phase 2 Site Access Road (N)		Minor
C	L2208 (E)		Major

Major Arm Geometry

Arm	Width of carriageway (m)	Has kerbed central reserve	Has right turn bay	Visibility for right turn (m)	Blocks?	Blocking queue (PCU)
C	7.20			100.0	✓	0.00

Geometries for Arm C are measured opposite Arm B. Geometries for Arm A (if relevant) are measured opposite Arm D.

Minor Arm Geometry

Arm	Minor arm type	Lane width (m)	Visibility to left (m)	Visibility to right (m)
B	One lane	2.50	45	45

Slope / Intercept / Capacity

Priority Intersection Slopes and Intercepts

Stream	Intercept (Veh/hr)	Slope for A-B	Slope for A-C	Slope for C-A	Slope for C-B
B-A	489	0.084	0.213	0.134	0.305
B-C	620	0.090	0.228	-	-
C-B	632	0.232	0.232	-	-

The slopes and intercepts shown above do NOT include any corrections or adjustments.

Streams may be combined, in which case capacity will be adjusted.

Values are shown for the first time segment only; they may differ for subsequent time segments.

Traffic Demand

Demand Set Details

ID	Scenario name	Time Period name	Traffic profile type	Start time (HH:mm)	Finish time (HH:mm)	Time segment length (min)	Single time segment only
D1	DO SOMETHING 2024	AM	FLAT	08:00	09:00	60	✓

Vehicle mix source	PCU Factor for a HV (PCU)
HV Percentages	2.00

Demand overview (Traffic)

Arm	Linked arm	Use O-D data	Average Demand (Veh/hr)	Scaling Factor (%)
A		✓	156	100.000
B		✓	86	100.000
C		✓	119	100.000

Origin-Destination Data

Demand (Veh/hr)

	To			
	A	B	C	
From	A	0	0	156
	B	0	0	86
	C	83	36	0

Vehicle Mix

Heavy Vehicle Percentages

	To			
	A	B	C	
From	A	0	0	5
	B	0	0	0
	C	5	0	0

Results

Results Summary for whole modelled period

Stream	Max RFC	Max Delay (s)	Max Queue (Veh)	Max LOS
B-AC	0.15	7.25	0.2	A
C-AB	0.06	5.93	0.1	A
C-A				
A-B				
A-C				

Main Results for each time segment

08:00 - 09:00

Stream	Total Demand (Veh/hr)	Capacity (Veh/hr)	RFC	Throughput (Veh/hr)	End queue (Veh)	Delay (s)	Unsignalised level of service
B-AC	86	582	0.148	86	0.2	7.249	A
C-AB	41	648	0.064	41	0.1	5.931	A
C-A	78			78			
A-B	0			0			
A-C	156			156			

JUNCTION 6 - DO SOMETHING 2024, PM

Data Errors and Warnings

No errors or warnings

Junction Network

Junctions

Junction	Name	Junction type	Major road direction	Use circulating lanes	Junction Delay (s)	Junction LOS
1	untitled	T-Junction	Two-way		1.93	A

Junction Network Options

Driving side	Lighting
Left	Normal/unknown

Traffic Demand

Demand Set Details

ID	Scenario name	Time Period name	Traffic profile type	Start time (HH:mm)	Finish time (HH:mm)	Time segment length (min)	Single time segment only
D2	DO SOMETHING 2024	PM	FLAT	17:00	18:00	60	✓

Vehicle mix source	PCU Factor for a HV (PCU)
HV Percentages	2.00

Demand overview (Traffic)

Arm	Linked arm	Use O-D data	Average Demand (Veh/hr)	Scaling Factor (%)
A		✓	72	100.000
B		✓	31	100.000
C		✓	200	100.000

Origin-Destination Data

Demand (Veh/hr)

		To		
		A	B	C
From	A	0	0	72
	B	0	0	31
	C	143	57	0

Vehicle Mix

Heavy Vehicle Percentages

		To		
		A	B	C
From	A	0	0	5
	B	0	0	0
	C	5	0	0

Results

Results Summary for whole modelled period

Stream	Max RFC	Max Delay (s)	Max Queue (Veh)	Max LOS
B-AC	0.05	6.30	0.1	A
C-AB	0.10	5.67	0.1	A
C-A				
A-B				
A-C				

Main Results for each time segment

17:00 - 18:00

Stream	Total Demand (Veh/hr)	Capacity (Veh/hr)	RFC	Throughput (Veh/hr)	End queue (Veh)	Delay (s)	Unsignalised level of service
B-AC	31	602	0.051	31	0.1	6.299	A
C-AB	71	706	0.101	71	0.1	5.672	A
C-A	129			129			
A-B	0			0			
A-C	72			72			

JUNCTION 6 - DO SOMETHING 2029, AM

Data Errors and Warnings

No errors or warnings

Junction Network

Junctions

Junction	Name	Junction type	Major road direction	Use circulating lanes	Junction Delay (s)	Junction LOS
1	untitled	T-Junction	Two-way		2.18	A

Junction Network Options

Driving side	Lighting
Left	Normal/unknown

Traffic Demand

Demand Set Details

ID	Scenario name	Time Period name	Traffic profile type	Start time (HH:mm)	Finish time (HH:mm)	Time segment length (min)	Single time segment only
D3	DO SOMETHING 2029	AM	FLAT	08:00	09:00	60	✓

Vehicle mix source	PCU Factor for a HV (PCU)
HV Percentages	2.00

Demand overview (Traffic)

Arm	Linked arm	Use O-D data	Average Demand (Veh/hr)	Scaling Factor (%)
A		✓	177	100.000
B		✓	86	100.000
C		✓	128	100.000

Origin-Destination Data

Demand (Veh/hr)

		To		
		A	B	C
From	A	0	0	177
	B	0	0	86
	C	92	36	0

Vehicle Mix

Heavy Vehicle Percentages

		To		
		A	B	C
From	A	0	0	5
	B	0	0	0
	C	5	0	0

Results

Results Summary for whole modelled period

Stream	Max RFC	Max Delay (s)	Max Queue (Veh)	Max LOS
B-AC	0.15	7.32	0.2	A
C-AB	0.06	5.93	0.1	A
C-A				
A-B				
A-C				

Main Results for each time segment

08:00 - 09:00

Stream	Total Demand (Veh/hr)	Capacity (Veh/hr)	RFC	Throughput (Veh/hr)	End queue (Veh)	Delay (s)	Unsignalised level of service
B-AC	86	577	0.149	86	0.2	7.323	A
C-AB	42	649	0.065	42	0.1	5.928	A
C-A	86			86			
A-B	0			0			
A-C	177			177			

JUNCTION 6 - DO SOMETHING 2029, PM

Data Errors and Warnings

No errors or warnings

Junction Network

Junctions

Junction	Name	Junction type	Major road direction	Use circulating lanes	Junction Delay (s)	Junction LOS
1	untitled	T-Junction	Two-way		1.77	A

Junction Network Options

Driving side	Lighting
Left	Normal/unknown

Traffic Demand

Demand Set Details

ID	Scenario name	Time Period name	Traffic profile type	Start time (HH:mm)	Finish time (HH:mm)	Time segment length (min)	Single time segment only
D4	DO SOMETHING 2029	PM	FLAT	17:00	18:00	60	✓

Vehicle mix source	PCU Factor for a HV (PCU)
HV Percentages	2.00

Demand overview (Traffic)

Arm	Linked arm	Use O-D data	Average Demand (Veh/hr)	Scaling Factor (%)
A		✓	83	100.000
B		✓	31	100.000
C		✓	220	100.000

Origin-Destination Data

Demand (Veh/hr)

		To		
		A	B	C
From	A	0	0	83
	B	0	0	31
	C	163	57	0

Vehicle Mix

Heavy Vehicle Percentages

		To		
		A	B	C
From	A	0	0	5
	B	0	0	0
	C	5	0	0

Results

Results Summary for whole modelled period

Stream	Max RFC	Max Delay (s)	Max Queue (Veh)	Max LOS
B-AC	0.05	6.33	0.1	A
C-AB	0.10	5.60	0.2	A
C-A				
A-B				
A-C				

Main Results for each time segment

17:00 - 18:00

Stream	Total Demand (Veh/hr)	Capacity (Veh/hr)	RFC	Throughput (Veh/hr)	End queue (Veh)	Delay (s)	Unsignalised level of service
B-AC	31	600	0.052	31	0.1	6.328	A
C-AB	74	716	0.103	74	0.2	5.600	A
C-A	146			146			
A-B	0			0			
A-C	83			83			

JUNCTION 6 - DO SOMETHING 2039, AM

Data Errors and Warnings

No errors or warnings

Junction Network

Junctions

Junction	Name	Junction type	Major road direction	Use circulating lanes	Junction Delay (s)	Junction LOS
1	untitled	T-Junction	Two-way		2.09	A

Junction Network Options

Driving side	Lighting
Left	Normal/unknown

Traffic Demand

Demand Set Details

ID	Scenario name	Time Period name	Traffic profile type	Start time (HH:mm)	Finish time (HH:mm)	Time segment length (min)	Single time segment only
D5	DO SOMETHING 2039	AM	FLAT	08:00	09:00	60	✓

Vehicle mix source	PCU Factor for a HV (PCU)
HV Percentages	2.00

Demand overview (Traffic)

Arm	Linked arm	Use O-D data	Average Demand (Veh/hr)	Scaling Factor (%)
A		✓	189	100.000
B		✓	86	100.000
C		✓	135	100.000

Origin-Destination Data

Demand (Veh/hr)

		To		
		A	B	C
From	A	0	0	189
	B	0	0	86
	C	99	36	0

Vehicle Mix

Heavy Vehicle Percentages

		To		
		A	B	C
From	A	0	0	5
	B	0	0	0
	C	5	0	0

Results

Results Summary for whole modelled period

Stream	Max RFC	Max Delay (s)	Max Queue (Veh)	Max LOS
B-AC	0.15	7.37	0.2	A
C-AB	0.07	5.91	0.1	A
C-A				
A-B				
A-C				

Main Results for each time segment

08:00 - 09:00

Stream	Total Demand (Veh/hr)	Capacity (Veh/hr)	RFC	Throughput (Veh/hr)	End queue (Veh)	Delay (s)	Unsignalised level of service
B-AC	86	574	0.150	86	0.2	7.366	A
C-AB	42	651	0.065	42	0.1	5.915	A
C-A	93			93			
A-B	0			0			
A-C	189			189			

JUNCTION 6 - DO SOMETHING 2039, PM

Data Errors and Warnings

No errors or warnings

Junction Network

Junctions

Junction	Name	Junction type	Major road direction	Use circulating lanes	Junction Delay (s)	Junction LOS
1	untitled	T-Junction	Two-way		1.70	A

Junction Network Options

Driving side	Lighting
Left	Normal/unknown

Traffic Demand

Demand Set Details

ID	Scenario name	Time Period name	Traffic profile type	Start time (HH:mm)	Finish time (HH:mm)	Time segment length (min)	Single time segment only
D6	DO SOMETHING 2039	PM	FLAT	17:00	18:00	60	✓

Vehicle mix source	PCU Factor for a HV (PCU)
HV Percentages	2.00

Demand overview (Traffic)

Arm	Linked arm	Use O-D data	Average Demand (Veh/hr)	Scaling Factor (%)
A		✓	88	100.000
B		✓	31	100.000
C		✓	232	100.000

Origin-Destination Data

Demand (Veh/hr)

		To		
		A	B	C
From	A	0	0	88
	B	0	0	31
	C	175	57	0

Vehicle Mix

Heavy Vehicle Percentages

		To		
		A	B	C
From	A	0	0	5
	B	0	0	0
	C	5	0	0

Results

Results Summary for whole modelled period

Stream	Max RFC	Max Delay (s)	Max Queue (Veh)	Max LOS
B-AC	0.05	6.34	0.1	A
C-AB	0.10	5.56	0.2	A
C-A				
A-B				
A-C				

Main Results for each time segment

17:00 - 18:00

Stream	Total Demand (Veh/hr)	Capacity (Veh/hr)	RFC	Throughput (Veh/hr)	End queue (Veh)	Delay (s)	Unsignalised level of service
B-AC	31	599	0.052	31	0.1	6.341	A
C-AB	75	723	0.104	75	0.2	5.555	A
C-A	157			157			
A-B	0			0			
A-C	88			88			

Junctions 9
ARCADY 9 - Roundabout Module
Version: 9.5.1.7462 © Copyright TRL Limited, 2019
For sales and distribution information, program advice and maintenance, contact TRL: +44 (0)1344 379777 software@trl.co.uk www.trlsoftware.co.uk
The users of this computer program for the solution of an engineering problem are in no way relieved of their responsibility for the correctness of the solution

Filename: Junction 7 AM-PM.j9

Path: M:\Projects\12\12-081A - Dunshaughlin Phase 2 - Civils\Design\Traffic\Modelling AUGUST 2020\Junction 7

Report generation date: 19/08/2020 12:17:04

- »JUNCTION 7 - DO SOMETHING 2024, AM
- »JUNCTION 7 - DO SOMETHING 2024, PM
- »JUNCTION 7 - DO SOMETHING 2029, AM
- »JUNCTION 7 - DO SOMETHING 2029, PM
- »JUNCTION 7 - DO SOMETHING 2039, AM
- »JUNCTION 7 - DO SOMETHING 2039, PM

Summary of junction performance

	AM					PM				
	Set ID	Queue (Veh)	Delay (s)	RFC	LOS	Set ID	Queue (Veh)	Delay (s)	RFC	LOS
JUNCTION 7 - DO SOMETHING 2024										
Arm 1	D1	0.0	2.78	0.04	A	D2	0.0	2.55	0.02	A
Arm 2		0.4	3.27	0.30	A		0.5	3.45	0.34	A
Arm 3		0.6	3.89	0.37	A		0.4	3.36	0.27	A
JUNCTION 7 - DO SOMETHING 2029										
Arm 1	D3	0.0	2.87	0.04	A	D4	0.0	2.72	0.02	A
Arm 2		0.6	3.73	0.39	A		0.7	3.84	0.41	A
Arm 3		0.7	4.20	0.42	A		0.6	3.87	0.36	A
JUNCTION 7 - DO SOMETHING 2039										
Arm 1	D5	0.0	2.91	0.04	A	D6	0.0	2.75	0.02	A
Arm 2		0.7	3.86	0.41	A		0.7	3.98	0.43	A
Arm 3		0.8	4.36	0.44	A		0.6	3.98	0.38	A

Values shown are the highest values encountered over all time segments. Delay is the maximum value of average delay per arriving vehicle.

File summary

File Description

Title	
Location	
Site number	
Date	22/07/2020
Version	
Status	(new file)
Identifier	
Client	
Jobnumber	
Enumerator	DOMAINf.silva
Description	

Units

Distance units	Speed units	Traffic units input	Traffic units results	Flow units	Average delay units	Total delay units	Rate of delay units
m	kph	Veh	Veh	perHour	s	-Min	perMin

Analysis Options

Calculate Queue Percentiles	Calculate residual capacity	RFC Threshold	Average Delay threshold (s)	Queue threshold (PCU)
		0.85	36.00	20.00

Demand Set Summary

ID	Scenario name	Time Period name	Traffic profile type	Start time (HH:mm)	Finish time (HH:mm)	Time segment length (min)	Single time segment only
D1	DO SOMETHING 2024	AM	FLAT	08:00	09:00	60	✓
D2	DO SOMETHING 2024	PM	FLAT	17:00	18:00	60	✓
D3	DO SOMETHING 2029	AM	FLAT	08:00	09:00	60	✓
D4	DO SOMETHING 2029	PM	FLAT	17:00	18:00	60	✓
D5	DO SOMETHING 2039	AM	FLAT	08:00	09:00	60	✓
D6	DO SOMETHING 2039	PM	FLAT	17:00	18:00	60	✓

Analysis Set Details

ID	Name	Network flow scaling factor (%)
A1	JUNCTION 7	100.000

JUNCTION 7 - DO SOMETHING 2024, AM

Data Errors and Warnings

No errors or warnings

Junction Network

Junctions

Junction	Name	Junction type	Use circulating lanes	Arm order	Junction Delay (s)	Junction LOS
1	untitled	Standard Roundabout		1, 2, 3	3.56	A

Junction Network Options

Driving side	Lighting
Left	Normal/unknown

Arms

Arms

Arm	Name	Description
1	Phase 2 Site Access Road (E)	
2	R125 (W)	
3	R125 (N)	

Roundabout Geometry

Arm	V - Approach road half-width (m)	E - Entry width (m)	I' - Effective flare length (m)	R - Entry radius (m)	D - Inscribed circle diameter (m)	PHI - Conflict (entry) angle (deg)	Exit only
1	3.80	6.40	15.0	20.0	58.0	30.0	
2	3.80	6.40	15.0	20.0	58.0	30.0	
3	3.80	6.20	10.0	17.0	58.0	30.0	

Slope / Intercept / Capacity

Roundabout Slope and Intercept used in model

Arm	Final slope	Final intercept (PCU/hr)
1	0.561	1658
2	0.561	1658
3	0.539	1549

The slope and intercept shown above include any corrections and adjustments.

Traffic Demand

Demand Set Details

ID	Scenario name	Time Period name	Traffic profile type	Start time (HH:mm)	Finish time (HH:mm)	Time segment length (min)	Single time segment only
D1	DO SOMETHING 2024	AM	FLAT	08:00	09:00	60	✓

Vehicle mix source	PCU Factor for a HV (PCU)
HV Percentages	2.00

Demand overview (Traffic)

Arm	Linked arm	Use O-D data	Average Demand (Veh/hr)	Scaling Factor (%)
1		✓	49	100.000
2		✓	480	100.000
3		✓	540	100.000

Origin-Destination Data

Demand (Veh/hr)

		To		
		1	2	3
From	1	0	41	8
	2	21	0	459
	3	4	536	0

Vehicle Mix

Heavy Vehicle Percentages

		To		
		1	2	3
From	1	0	0	0
	2	0	0	5
	3	0	5	0

Results

Results Summary for whole modelled period

Arm	Max RFC	Max Delay (s)	Max Queue (Veh)	Max LOS
1	0.04	2.78	0.0	A
2	0.30	3.27	0.4	A
3	0.37	3.89	0.6	A

Main Results for each time segment

08:00 - 09:00

Arm	Total Demand (Veh/hr)	Circulating flow (Veh/hr)	Capacity (Veh/hr)	RFC	Throughput (Veh/hr)	End queue (Veh)	Delay (s)	Unsignalised level of service
1	49	535	1343	0.036	49	0.0	2.781	A
2	480	8	1578	0.304	480	0.4	3.274	A
3	540	21	1465	0.369	539	0.6	3.886	A

JUNCTION 7 - DO SOMETHING 2024, PM

Data Errors and Warnings

No errors or warnings

Junction Network

Junctions

Junction	Name	Junction type	Use circulating lanes	Arm order	Junction Delay (s)	Junction LOS
1	untitled	Standard Roundabout		1, 2, 3	3.39	A

Junction Network Options

Driving side	Lighting
Left	Normal/unknown

Traffic Demand

Demand Set Details

ID	Scenario name	Time Period name	Traffic profile type	Start time (HH:mm)	Finish time (HH:mm)	Time segment length (min)	Single time segment only
D2	DO SOMETHING 2024	PM	FLAT	17:00	18:00	60	✓

Vehicle mix source	PCU Factor for a HV (PCU)
HV Percentages	2.00

Demand overview (Traffic)

Arm	Linked arm	Use O-D data	Average Demand (Veh/hr)	Scaling Factor (%)
1		✓	23	100.000
2		✓	538	100.000
3		✓	391	100.000

Origin-Destination Data

Demand (Veh/hr)

		To		
		1	2	3
From	1	0	19	4
	2	29	0	509
	3	6	385	0

Vehicle Mix

Heavy Vehicle Percentages

		To		
		1	2	3
From	1	0	0	0
	2	0	0	5
	3	0	5	0

Results

Results Summary for whole modelled period

Arm	Max RFC	Max Delay (s)	Max Queue (Veh)	Max LOS
1	0.02	2.55	0.0	A
2	0.34	3.45	0.5	A
3	0.27	3.36	0.4	A

Main Results for each time segment

17:00 - 18:00

Arm	Total Demand (Veh/hr)	Circulating flow (Veh/hr)	Capacity (Veh/hr)	RFC	Throughput (Veh/hr)	End queue (Veh)	Delay (s)	Unsignalised level of service
1	23	385	1432	0.016	23	0.0	2.555	A
2	538	4	1581	0.340	537	0.5	3.447	A
3	391	29	1462	0.268	391	0.4	3.361	A

JUNCTION 7 - DO SOMETHING 2029, AM

Data Errors and Warnings

No errors or warnings

Junction Network

Junctions

Junction	Name	Junction type	Use circulating lanes	Arm order	Junction Delay (s)	Junction LOS
1	untitled	Standard Roundabout		1, 2, 3	3.92	A

Junction Network Options

Driving side	Lighting
Left	Normal/unknown

Traffic Demand

Demand Set Details

ID	Scenario name	Time Period name	Traffic profile type	Start time (HH:mm)	Finish time (HH:mm)	Time segment length (min)	Single time segment only
D3	DO SOMETHING 2029	AM	FLAT	08:00	09:00	60	✓

Vehicle mix source	PCU Factor for a HV (PCU)
HV Percentages	2.00

Demand overview (Traffic)

Arm	Linked arm	Use O-D data	Average Demand (Veh/hr)	Scaling Factor (%)
1		✓	49	100.000
2		✓	613	100.000
3		✓	610	100.000

Origin-Destination Data

Demand (Veh/hr)

		To		
		1	2	3
From	1	0	41	8
	2	21	0	592
	3	4	606	0

Vehicle Mix

Heavy Vehicle Percentages

		To		
		1	2	3
From	1	0	0	0
	2	0	0	5
	3	0	5	0

Results

Results Summary for whole modelled period

Arm	Max RFC	Max Delay (s)	Max Queue (Veh)	Max LOS
1	0.04	2.87	0.0	A
2	0.39	3.73	0.6	A
3	0.42	4.20	0.7	A

Main Results for each time segment

08:00 - 09:00

Arm	Total Demand (Veh/hr)	Circulating flow (Veh/hr)	Capacity (Veh/hr)	RFC	Throughput (Veh/hr)	End queue (Veh)	Delay (s)	Unsignalised level of service
1	49	605	1302	0.038	49	0.0	2.873	A
2	613	8	1577	0.389	612	0.6	3.728	A
3	610	21	1465	0.416	609	0.7	4.202	A

JUNCTION 7 - DO SOMETHING 2029, PM

Data Errors and Warnings

No errors or warnings

Junction Network

Junctions

Junction	Name	Junction type	Use circulating lanes	Arm order	Junction Delay (s)	Junction LOS
1	untitled	Standard Roundabout		1, 2, 3	3.84	A

Junction Network Options

Driving side	Lighting
Left	Normal/unknown

Traffic Demand

Demand Set Details

ID	Scenario name	Time Period name	Traffic profile type	Start time (HH:mm)	Finish time (HH:mm)	Time segment length (min)	Single time segment only
D4	DO SOMETHING 2029	PM	FLAT	17:00	18:00	60	✓

Vehicle mix source	PCU Factor for a HV (PCU)
HV Percentages	2.00

Demand overview (Traffic)

Arm	Linked arm	Use O-D data	Average Demand (Veh/hr)	Scaling Factor (%)
1		✓	23	100.000
2		✓	645	100.000
3		✓	533	100.000

Origin-Destination Data

Demand (Veh/hr)

		To		
		1	2	3
From	1	0	19	4
	2	29	0	616
	3	6	527	0

Vehicle Mix

Heavy Vehicle Percentages

		To		
		1	2	3
From	1	0	0	0
	2	0	0	5
	3	0	5	0

Results

Results Summary for whole modelled period

Arm	Max RFC	Max Delay (s)	Max Queue (Veh)	Max LOS
1	0.02	2.72	0.0	A
2	0.41	3.84	0.7	A
3	0.36	3.87	0.6	A

Main Results for each time segment

17:00 - 18:00

Arm	Total Demand (Veh/hr)	Circulating flow (Veh/hr)	Capacity (Veh/hr)	RFC	Throughput (Veh/hr)	End queue (Veh)	Delay (s)	Unsignalised level of service
1	23	526	1348	0.017	23	0.0	2.716	A
2	645	4	1580	0.408	644	0.7	3.843	A
3	533	29	1461	0.365	532	0.6	3.873	A

JUNCTION 7 - DO SOMETHING 2039, AM

Data Errors and Warnings

No errors or warnings

Junction Network

Junctions

Junction	Name	Junction type	Use circulating lanes	Arm order	Junction Delay (s)	Junction LOS
1	untitled	Standard Roundabout		1, 2, 3	4.07	A

Junction Network Options

Driving side	Lighting
Left	Normal/unknown

Traffic Demand

Demand Set Details

ID	Scenario name	Time Period name	Traffic profile type	Start time (HH:mm)	Finish time (HH:mm)	Time segment length (min)	Single time segment only
D5	DO SOMETHING 2039	AM	FLAT	08:00	09:00	60	✓

Vehicle mix source	PCU Factor for a HV (PCU)
HV Percentages	2.00

Demand overview (Traffic)

Arm	Linked arm	Use O-D data	Average Demand (Veh/hr)	Scaling Factor (%)
1		✓	49	100.000
2		✓	645	100.000
3		✓	641	100.000

Origin-Destination Data

Demand (Veh/hr)

		To		
		1	2	3
From	1	0	41	8
	2	21	0	624
	3	4	637	0

Vehicle Mix

Heavy Vehicle Percentages

		To		
		1	2	3
From	1	0	0	0
	2	0	0	5
	3	0	5	0

Results

Results Summary for whole modelled period

Arm	Max RFC	Max Delay (s)	Max Queue (Veh)	Max LOS
1	0.04	2.91	0.0	A
2	0.41	3.86	0.7	A
3	0.44	4.36	0.8	A

Main Results for each time segment

08:00 - 09:00

Arm	Total Demand (Veh/hr)	Circulating flow (Veh/hr)	Capacity (Veh/hr)	RFC	Throughput (Veh/hr)	End queue (Veh)	Delay (s)	Unsignalised level of service
1	49	636	1284	0.038	49	0.0	2.915	A
2	645	8	1577	0.409	644	0.7	3.856	A
3	641	21	1465	0.438	640	0.8	4.361	A

JUNCTION 7 - DO SOMETHING 2039, PM

Data Errors and Warnings

No errors or warnings

Junction Network

Junctions

Junction	Name	Junction type	Use circulating lanes	Arm order	Junction Delay (s)	Junction LOS
1	untitled	Standard Roundabout		1, 2, 3	3.96	A

Junction Network Options

Driving side	Lighting
Left	Normal/unknown

Traffic Demand

Demand Set Details

ID	Scenario name	Time Period name	Traffic profile type	Start time (HH:mm)	Finish time (HH:mm)	Time segment length (min)	Single time segment only
D6	DO SOMETHING 2039	PM	FLAT	17:00	18:00	60	✓

Vehicle mix source	PCU Factor for a HV (PCU)
HV Percentages	2.00

Demand overview (Traffic)

Arm	Linked arm	Use O-D data	Average Demand (Veh/hr)	Scaling Factor (%)
1		✓	23	100.000
2		✓	677	100.000
3		✓	558	100.000

Origin-Destination Data

Demand (Veh/hr)

		To		
		1	2	3
From	1	0	19	4
	2	29	0	648
	3	6	552	0

Vehicle Mix

Heavy Vehicle Percentages

		To		
		1	2	3
From	1	0	0	0
	2	0	0	5
	3	0	5	0

Results

Results Summary for whole modelled period

Arm	Max RFC	Max Delay (s)	Max Queue (Veh)	Max LOS
1	0.02	2.75	0.0	A
2	0.43	3.98	0.7	A
3	0.38	3.98	0.6	A

Main Results for each time segment

17:00 - 18:00

Arm	Total Demand (Veh/hr)	Circulating flow (Veh/hr)	Capacity (Veh/hr)	RFC	Throughput (Veh/hr)	End queue (Veh)	Delay (s)	Unsignalised level of service
1	23	551	1333	0.017	23	0.0	2.746	A
2	677	4	1580	0.428	676	0.7	3.979	A
3	558	29	1461	0.382	557	0.6	3.980	A

Junctions 9
ARCADY 9 - Roundabout Module
Version: 9.5.1.7462 © Copyright TRL Limited, 2019
For sales and distribution information, program advice and maintenance, contact TRL: +44 (0)1344 379777 software@trl.co.uk www.trlsoftware.co.uk
The users of this computer program for the solution of an engineering problem are in no way relieved of their responsibility for the correctness of the solution

Filename: Junction 3 - AM-PM.j9
Path: M:\Projects\12\12-081A - Dunshaughlin Phase 2 - Civils\Design\Traffic\Modelling SEPTEMBER 2020\Option 2 - South Site - Two Separate Areas\Junction 3
Report generation date: 18/09/2020 14:23:31

- »JUNCTION 3 - Assessment of Layout Option 2 - DO SOMETHING 2039, AM
- »JUNCTION 3 - Assessment of Layout Option 2 - DO SOMETHING 2039, PM

Summary of junction performance

	AM					PM				
	Set ID	Queue (Veh)	Delay (s)	RFC	LOS	Set ID	Queue (Veh)	Delay (s)	RFC	LOS
JUNCTION 3 - Assessment of Layout Option 2 - DO SOMETHING 2039										
Arm 1	D1	0.8	5.58	0.43	A	D2	0.7	4.99	0.40	A
Arm 2		0.6	4.20	0.38	A		0.7	4.26	0.40	A
Arm 3		0.4	5.20	0.29	A		0.1	3.85	0.11	A
Arm 4		0.3	3.84	0.21	A		0.1	3.21	0.10	A

Values shown are the highest values encountered over all time segments. Delay is the maximum value of average delay per arriving vehicle.

File summary

File Description

Title	
Location	
Site number	
Date	04/03/2020
Version	
Status	(new file)
Identifier	
Client	
Jobnumber	
Enumerator	DOMAINf.silva
Description	

Units

Distance units	Speed units	Traffic units input	Traffic units results	Flow units	Average delay units	Total delay units	Rate of delay units
m	kph	Veh	Veh	perHour	s	-Min	perMin

Analysis Options

Calculate Queue Percentiles	Calculate residual capacity	RFC Threshold	Average Delay threshold (s)	Queue threshold (PCU)
		0.85	36.00	20.00

Demand Set Summary

ID	Scenario name	Time Period name	Traffic profile type	Start time (HH:mm)	Finish time (HH:mm)	Time segment length (min)	Single time segment only
D1	DO SOMETHING 2039	AM	FLAT	08:00	09:00	60	✓
D2	DO SOMETHING 2039	PM	FLAT	17:00	18:00	60	✓

Analysis Set Details

ID	Name	Network flow scaling factor (%)
A1	JUNCTION 3 - Assessment of Layout Option 2	100.000

JUNCTION 3 - Assessment of Layout Option 2 - DO SOMETHING 2039, AM

Data Errors and Warnings

No errors or warnings

Junction Network

Junctions

Junction	Name	Junction type	Use circulating lanes	Arm order	Junction Delay (s)	Junction LOS
1	untitled	Standard Roundabout		1, 2, 3, 4	4.76	A

Junction Network Options

Driving side	Lighting
Left	Normal/unknown

Arms

Arms

Arm	Name	Description
1	Drumree Road (E)	
2	R125 (S)	
3	L2208 (W)	
4	R125 (N)	

Roundabout Geometry

Arm	V - Approach road half-width (m)	E - Entry width (m)	I' - Effective flare length (m)	R - Entry radius (m)	D - Inscribed circle diameter (m)	PHI - Conflict (entry) angle (deg)	Exit only
1	3.80	4.80	4.0	20.0	50.0	30.0	
2	3.80	6.10	12.0	16.0	50.0	30.0	
3	3.80	5.50	4.6	20.0	50.0	30.0	
4	3.80	6.60	8.1	17.0	50.0	30.0	

Zebra Crossings

Arm	Space between crossing and junction entry (Zebra) (PCU)	Vehicles queueing on exit (Zebra) (PCU)	Central Refuge	Crossing data type	Crossing length (m)	Crossing time (s)
4	1.00	1.00		Distance	12.00	8.57

Slope / Intercept / Capacity

Roundabout Slope and Intercept used in model

Arm	Final slope	Final intercept (PCU/hr)
1	0.537	1320
2	0.579	1564
3	0.549	1387
4	0.576	1541

The slope and intercept shown above include any corrections and adjustments.

Traffic Demand

Demand Set Details

ID	Scenario name	Time Period name	Traffic profile type	Start time (HH:mm)	Finish time (HH:mm)	Time segment length (min)	Single time segment only
D1	DO SOMETHING 2039	AM	FLAT	08:00	09:00	60	✓

Vehicle mix source	PCU Factor for a HV (PCU)
HV Percentages	2.00

Demand overview (Traffic)

Arm	Linked arm	Use O-D data	Average Demand (Veh/hr)	Scaling Factor (%)
1		✓	494	100.000
2		✓	526	100.000
3		✓	276	100.000
4		✓	244	100.000

Demand overview (Pedestrians)

Arm	Average pedestrian flow (Ped/hr)
1	
2	
3	
4	50.00

Origin-Destination Data

Demand (Veh/hr)

		To			
		1	2	3	4
From	1	0	307	77	110
	2	299	0	40	187
	3	132	103	0	41
	4	80	146	18	0

Vehicle Mix

Heavy Vehicle Percentages

		To			
		1	2	3	4
From	1	0	5	0	0
	2	5	0	0	5
	3	0	0	0	0
	4	0	5	0	0

Results

Results Summary for whole modelled period

Arm	Max RFC	Max Delay (s)	Max Queue (Veh)	Max LOS
1	0.43	5.58	0.8	A
2	0.38	4.20	0.6	A
3	0.29	5.20	0.4	A
4	0.21	3.84	0.3	A

Main Results for each time segment

08:00 - 09:00

Arm	Total Demand (Veh/hr)	Circulating flow (Veh/hr)	Pedestrian demand (Ped/hr)	Capacity (Veh/hr)	RFC	Throughput (Veh/hr)	End queue (Veh)	Delay (s)	Unsignalised level of service
1	494	267		1137	0.434	493	0.8	5.581	A
2	526	205		1382	0.381	525	0.6	4.202	A
3	276	595		968	0.285	276	0.4	5.195	A
4	244	533	50.00	1180	0.207	244	0.3	3.844	A

JUNCTION 3 - Assessment of Layout Option 2 - DO SOMETHING 2039, PM

Data Errors and Warnings

No errors or warnings

Junction Network

Junctions

Junction	Name	Junction type	Use circulating lanes	Arm order	Junction Delay (s)	Junction LOS
1	untitled	Standard Roundabout		1, 2, 3, 4	4.40	A

Junction Network Options

Driving side	Lighting
Left	Normal/unknown

Traffic Demand

Demand Set Details

ID	Scenario name	Time Period name	Traffic profile type	Start time (HH:mm)	Finish time (HH:mm)	Time segment length (min)	Single time segment only
D2	DO SOMETHING 2039	PM	FLAT	17:00	18:00	60	✓

Vehicle mix source	PCU Factor for a HV (PCU)
HV Percentages	2.00

Demand overview (Traffic)

Arm	Linked arm	Use O-D data	Average Demand (Veh/hr)	Scaling Factor (%)
1		✓	484	100.000
2		✓	555	100.000
3		✓	119	100.000
4		✓	125	100.000

Demand overview (Pedestrians)

Arm	Average pedestrian flow (Ped/hr)
1	
2	
3	
4	50.00

Origin-Destination Data

Demand (Veh/hr)

		To			
		1	2	3	4
From	1	0	315	138	31
	2	295	0	81	179
	3	66	41	0	12
	4	27	85	13	0

Vehicle Mix

Heavy Vehicle Percentages

From	To			
	1	2	3	4
1	0	5	0	0
2	5	0	0	5
3	0	0	0	0
4	0	5	0	0

Results

Results Summary for whole modelled period

Arm	Max RFC	Max Delay (s)	Max Queue (Veh)	Max LOS
1	0.40	4.99	0.7	A
2	0.40	4.26	0.7	A
3	0.11	3.85	0.1	A
4	0.10	3.21	0.1	A

Main Results for each time segment

17:00 - 18:00

Arm	Total Demand (Veh/hr)	Circulating flow (Veh/hr)	Pedestrian demand (Ped/hr)	Capacity (Veh/hr)	RFC	Throughput (Veh/hr)	End queue (Veh)	Delay (s)	Unsignalised level of service
1	484	139		1204	0.402	483	0.7	4.993	A
2	555	182		1399	0.397	554	0.7	4.260	A
3	119	504		1054	0.113	119	0.1	3.848	A
4	125	402	50.00	1247	0.100	125	0.1	3.208	A

TRANSYT 16
Version: 16.0.1.8473 © Copyright TRL Limited, 2019
For sales and distribution information, program advice and maintenance, contact TRL: +44 (0)1344 379777 software@trl.co.uk www.trisoftware.co.uk
The users of this computer program for the solution of an engineering problem are in no way relieved of their responsibility for the correctness of the solution

Filename: Junction 4 - AM.t16

Path: M:\Projects\12\12-081A - Dunshaughlin Phase 2 - Civils\Design\Traffic\Modelling SEPTEMBER 2020\Option 2 - South Site - Two Separate Areas\Junction 4

Report generation date: 18/09/2020 14:30:28

»Network Diagrams

«A6 - DO SOMETHING 2039 - Assessment Layout Option 2 : D6 - DO SOMETHING 2039, :

»Summary

»Arms and Traffic Streams

»Pedestrian Crossings

»Local OD Matrix - Local Matrix: 1

»Signal Timings

»Traffic Stream Results

»Pedestrian Crossing Results

»Network Results

»Final Prediction Table

Summary of network performance

	PI (£ per hr)	Total delay (Veh-hr/hr)	Highest DOS	Number oversaturated
DO SOMETHING 2039 - Assessment Layout Option 2 - DO SOMETHING 2039				
Network	299.80	20.10	86% (TS C/1)	0 (0%)

File summary

File description

File title	(untitled)
Location	
Site number	
UTCRegion	
Driving side	Left
Date	06/12/2011
Version	
Status	(new file)
Identifier	
Client	
Jobnumber	
Enumerator	DOMAINf.silva
Description	

Model and Results

Enable controller offsets	Enable fuel consumption	Enable quick flares	Display journey time results	Display OD matrix distances	Display level of service results	Display blocking and starvation results	Display end of red and green queue results	Display excess queue results	Display separate uniform and random results	Display unweighted results	Display TRANSYT 12 style timings	Display effective greens in results	Display Red-With-Amber	Display End-Of-Green Amber	c
			✓			✓		✓	✓						m

Units

Cost units	Speed units	Distance units	Fuel economy units	Fuel rate units	Mass units	Traffic units input	Traffic units results	Flow units	Average delay units	Total delay units	Rate of delay units
£	kph	m	mpg	l/h	kg	Veh	Veh	perHour	s	-Hour	perHour

Sorting

Show names instead of IDs	Sorting direction	Sorting type	Ignore prefixes when sorting	Analysis/demand set sorting	Link grouping	Source grouping	Colour Analysis/Demand Sets
	Ascending	Numerical		ID	Normal	Normal	✓

Simulation options

Criteria type	Stop criteria (%)	Stop criteria time (s)	Stop criteria number of trials	Random seed	Results refresh speed (s)	Average animation capture interval (s)	Use quick response	Do flow sampling	Uniform vehicle generation	Last run random seed	Last run number of trials	Last run time taken (s)
Delay	3.00	999	200	-1	3	60	✓			0	0	0.00

Network Diagrams

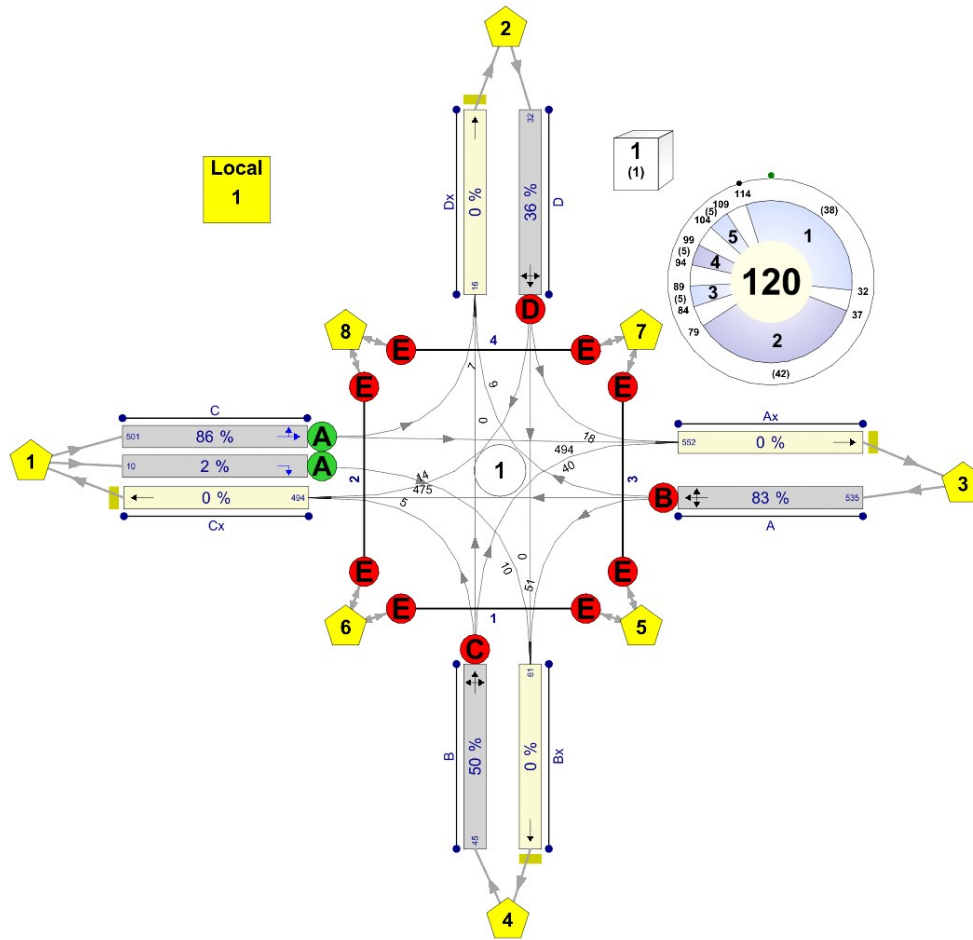

(untitled)
Diagram produced using TRANSYT 16.0.1.8473

A6 - DO SOMETHING 2039 - Assessment Layout Option 2

D6 - DO SOMETHING 2039,

Summary

Data Errors and Warnings

No errors or warnings

Run Summary

Analysis set used	Run start time	Run finish time	Run duration (s)	Modelling start time (HH:mm)	Network Cycle Time (s)	Performance Index (£ per hr)	Total network delay (Veh-hr/hr)	Highest DOS (%)	Item with highest DOS	Number of oversaturated items	Percentage of oversaturated items (%)	Item with worst signalised PRC	Item with worst unsignal PRC
6	18/09/2020 14:30:18	18/09/2020 14:30:19	1.81	08:00	120	299.80	20.10	85.64	C/1	0	0	C/1	Dx/1

Analysis Set Details

Name	Use Simulation	Description	Use specific Demand Set(s)	Specific Demand Set(s)	Optimise specific Demand Set(s)	Include in report	Locked
DO SOMETHING 2039 - Assessment Layout Option 2		AM	✓	D6		✓	

Demand Set Details

Scenario name	Time Period name	Description	Composite	Demand sets	Start time (HH:mm)	Locked	Run automatically
DO SOMETHING 2039		AM			08:00		✓

Arms and Traffic Streams

Arms

Arm	Name	Description	Traffic node
A	(untitled)		1
Ax	(untitled)		
B	(untitled)		1
Bx	(untitled)		
C	(untitled)		1
Cx	(untitled)		
D	(untitled)		1
Dx	(untitled)		

Traffic Streams

Arm	Traffic Stream	Name	Description	Auto length	Length (m)	Has Saturation Flow	Saturation flow source	Saturation flow (PCU/hr)	Is signal controlled	Is give way	Traffic type	Allow Nearside Turn On Red
A	1	(untitled)		✓	50.00	✓	Sum of lanes	1800	✓		Normal	
Ax	1	(untitled)		✓	137.53						Normal	
B	1	(untitled)		✓	50.00	✓	Sum of lanes	1800	✓		Normal	
Bx	1	(untitled)		✓	138.27						Normal	
C	1	(untitled)		✓	50.00	✓	Sum of lanes	1800	✓		Normal	
	2	(untitled)		✓	50.00	✓	Sum of lanes	1800	✓		Normal	
Cx	1	(untitled)		✓	140.00						Normal	
D	1	(untitled)		✓	50.00	✓	Sum of lanes	1800	✓		Normal	
Dx	1	(untitled)		✓	137.05						Normal	

Lanes

Arm	Traffic Stream	Lane	Name	Description	Use RR67	Saturation flow (PCU/hr)
A	1	1	(untitled)			1800
Ax	1	1	(untitled)			
B	1	1	(untitled)			1800
Bx	1	1	(untitled)			
C	1	1	(untitled)			1800
	2	1	(untitled)			1800
Cx	1	1	(untitled)			
D	1	1	(untitled)			1800
Dx	1	1	(untitled)			

Modelling

Arm	Traffic Stream	Traffic model	Stop weighting multiplier (%)	Delay weighting multiplier (%)	Assignment Cost Weighting (%)	Exclude from results calculation	Max queue storage (PCU)	Has queue limit	Has degree of saturation limit
(ALL)	(ALL)	NetworkDefault	100	100	100		0.00		

Modelling - Advanced

Arm	Traffic Stream	Initial queue (PCU)	Type of Vehicle-in-Service	Vehicle-in-Service	Type of random parameter	Random parameter	Auto cycle time	Cycle time
(ALL)	(ALL)	0.00	NetworkDefault	Not-Included	NetworkDefault	0.50	✓	120

Normal traffic - Modelling

Arm	Traffic Stream	Stop weighting (%)	Delay weighting (%)
(ALL)	(ALL)	100	100

Normal traffic - Advanced

Arm	Traffic Stream	Dispersion type for Normal Traffic
(ALL)	(ALL)	NetworkDefault

Flows

Arm	Traffic Stream	Total Flow (Veh/hr)	Normal Flow (Veh/hr)
A	1	535	535
Ax	1	552	552
B	1	45	45
Bx	1	61	61
C	1	501	501
	2	10	10
Cx	1	494	494
D	1	32	32
Dx	1	16	16

Signals

Arm	Traffic Stream	Controller stream	Phase	Second phase enabled
A	1	1	B	
B	1	1	C	
C	1	1	A	
	2	1	A	
D	1	1	D	

Pedestrian Crossings

Pedestrian Crossings

Crossing	Name	Description	Traffic node	Allow walk on red	Crossing type	Length (m)	Cruise time (seconds)	Cruise speed (kph)
1	(untitled)		1		Farside	7.00	4.67	5.40
2	(untitled)		1		Farside	8.00	5.33	5.40
3	(untitled)		1		Farside	8.00	5.33	5.40
4	(untitled)		1		Farside	7.00	4.67	5.40

Pedestrian Crossings - Signals

Crossing	Controller stream	Phase	Second phase enabled
(ALL)	1	E	

Pedestrian Crossings - Sides

Crossing	Side	Saturation flow (Ped/hr)
(ALL)	(ALL)	11000

Pedestrian Crossings - Modelling

Crossing	Side	Delay weighting (%)	Assignment Cost Weighting (%)	Exclude from results calculation	Max queue storage (Ped)	Has queue limit	Has degree of saturation limit
(ALL)	(ALL)	100	100		0.00		

Local OD Matrix - Local Matrix: 1

Local Matrix Options

OD Matrix	Name	Use for point to point table	Auto calculate	Allocation mode	Allow paths past exit locations	Allow looped paths on arms	Allow looped paths on traffic nodes	Copy flows	Matrix to copy flows from	Limit paths by length	Path length limit multiplier	Limit paths by number	Path number limit	Limit paths by flow	Low path flow threshold
1	(untitled)	✓	✓	Path Equalisation	✓		✓			✓	1.25				

Normal Input Flows (Veh/hr)

		To							
		1	2	3	4	5	6	7	8
From	1	0	7	494	10	0	0	0	0
	2	14	0	18	0	0	0	0	0
	3	475	9	0	51	0	0	0	0
	4	5	0	40	0	0	0	0	0
	5	0	0	0	0	0	0	0	0
	6	0	0	0	0	0	0	0	0
	7	0	0	0	0	0	0	0	0
	8	0	0	0	0	0	0	0	0

Bus Input Flows not shown as they are blank.

Tram Input Flows not shown as they are blank.

Pedestrian Input Flows (Veh/hr)

From	To							
	1	2	3	4	5	6	7	8
1	0	0	0	0	0	0	0	0
2	0	0	0	0	0	0	0	0
3	0	0	0	0	0	0	0	0
4	0	0	0	0	0	0	0	0
5	0	0	0	0	0	30	30	0
6	0	0	0	0	30	0	0	30
7	0	0	0	0	30	0	0	30
8	0	0	0	0	0	30	30	0

Locations

OD Matrix	Location	Name	Entries	Exits	Colour
1	1	(untitled)	C/1, C/2	Cx/1	#0000FF
	2	(untitled)	D/1	Dx/1	#FF0000
	3	(untitled)	A/1	Ax/1	#00FF00
	4	(untitled)	B/1	Bx/1	#FFFF00
	5	(untitled)	3:2E, 1:1E	3:2X, 1:1X	#FF00FF
	6	(untitled)	2:1E, 1:2E	2:1X, 1:2X	#008000
	7	(untitled)	4:2E, 3:1E	4:2X, 3:1X	#FFA500
	8	(untitled)	4:1E, 2:2E	4:1X, 2:2X	#00FFFF

Normal Paths and Flows

OD Matrix	Path	Description	From location	To location	Path items	Allocation type	Normal Calculated Flow (Veh/hr)
1	1		1	2	C/1, Dx/1	Normal	7
	2		1	3	C/1, Ax/1	Normal	494
	5		2	3	D/1, Ax/1	Normal	18
	6		2	4	D/1, Bx/1	Normal	0
	7		2	1	D/1, Cx/1	Normal	14
	8		3	2	A/1, Dx/1	Normal	9
	9		3	4	A/1, Bx/1	Normal	51
	10		3	1	A/1, Cx/1	Normal	475
	11		4	2	B/1, Dx/1	Normal	0
	12		4	3	B/1, Ax/1	Normal	40
	13		4	1	B/1, Cx/1	Normal	5
	21		1	4	C/2, Bx/1	Normal	10

Pedestrian Paths and Flows

OD Matrix	Path	Description	From location	To location	Path items	Allocation type	Pedestrian calculated flow (Ped/hr)
1	17		8	7	4:1E, 4:2X	Normal	30
	18		8	6	2:2E, 2:1X	Normal	30
	22		5	7	3:2E, 3:1X	Normal	30
	23		5	6	1:1E, 1:2X	Normal	30
	34		6	8	2:1E, 2:2X	Normal	30
	35		6	5	1:2E, 1:1X	Normal	30
	41		7	8	4:2E, 4:1X	Normal	30
	42		7	5	3:1E, 3:2X	Normal	30

Signal Timings

Network Default: 120s cycle time; 120 steps

Controller Stream 1

Controller Stream	Name	Description	Use sequence	Cycle time source	Cycle time (s)	Minimum possible cycle time (s)
1	(untitled)		1	NetworkDefault	120	83

Controller Stream 1 - Properties

Controller Stream	Manufacturer name	Type	Model number	(Telephone) Line Number	Site number	Grid reference	Gaining delay type
1	Unspecified						Relative

Controller Stream 1 - Optimisation

Controller Stream	Allow offset optimisation	Allow green split optimisation	Optimisation level	Auto redistribute	Enable stage constraint
1	✓	✓	Offsets And Green Splits	✓	

Phases

Controller Stream	Phase	Name	Street minimum green (s)	Maximum green (s)	Relative start displacement (s)	Relative end displacement (s)	Type	Blackout Time (s)
1	A	(untitled)	38	300	0	0	Traffic	
	B	(untitled)	5	300	0	0	Traffic	
	C	(untitled)	5	300	0	0	Traffic	
	D	(untitled)	5	300	0	0	Traffic	
	E	(untitled)	5	300	0	0	Pedestrian	0

Library Stages

Controller Stream	Library Stage	Phases in stage	User stage minimum (s)	Run every N cycles	Probability of running (%)
1	1	A	1	1	100
	2	B	1	1	100
	3	C	1	1	100
	4	D	1	1	100
	5	E	1	1	100

Stage Sequences

Controller Stream	Sequence	Name	Multiple cycling	Stage IDs	Stage ends	Minimum possible cycle time (s)	Exclude from analysis
1	1	(untitled)	Single	1, 2, 3, 4, 5	32, 79, 89, 99, 109	83	

Intergreen Matrix for Controller Stream 1

		To				
		A	B	C	D	E
From	A		5	5	5	5
	B	5		5	5	5
	C	5	5		5	5
	D	5	5	5		5
	E	5	5	5	5	

Banned Stage transitions for Controller Stream 1

		To				
		1	2	3	4	5
From	1					
	2					
	3					
	4					
	5					

Interstage Matrix for Controller Stream 1

From	To				
	1	2	3	4	5
1	0	5	5	5	5
2	5	0	5	5	5
3	5	5	0	5	5
4	5	5	5	0	5
5	5	5	5	5	0

Resultant Stages

Controller Stream	Resultant Stage	Is base stage	Library Stage ID	Phases in this stage	Stage start (s)	Stage end (s)	Stage duration (s)	User stage minimum (s)	Stage minimum (s)
1	1	✓	1	A	114	32	38	1	38
	2	✓	2	B	37	79	42	1	5
	3	✓	3	C	84	89	5	1	5
	4	✓	4	D	94	99	5	1	5
	5	✓	5	E	104	109	5	1	5

Resultant Phase Green Periods

Controller Stream	Phase	Green period	Is base green period	Start time (s)	End time (s)	Duration (s)
1	A	1	✓	114	32	38
	B	1	✓	37	79	42
	C	1	✓	84	89	5
	D	1	✓	94	99	5
	E	1	✓	104	109	5

Traffic Stream Green Times

Arm	Traffic Stream	Traffic Node	Controller Stream	Phase	Green Period 1		
					Start	End	Duration
A	1	1	1	B	37	79	42
B	1	1	1	C	84	89	5
C	1	1	1	A	114	32	38
C	2	1	1	A	114	32	38
D	1	1	1	D	94	99	5

Phase Timings Diagram for Controller Stream 1

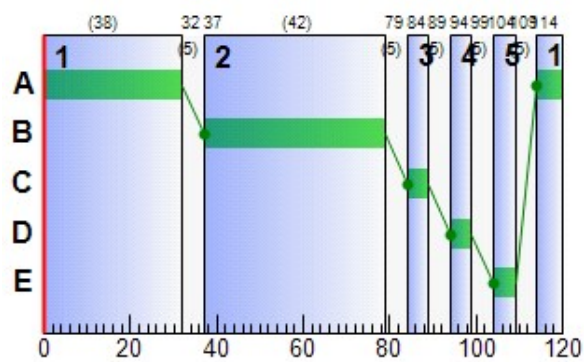

Stage Sequence Diagram for Controller Stream 1

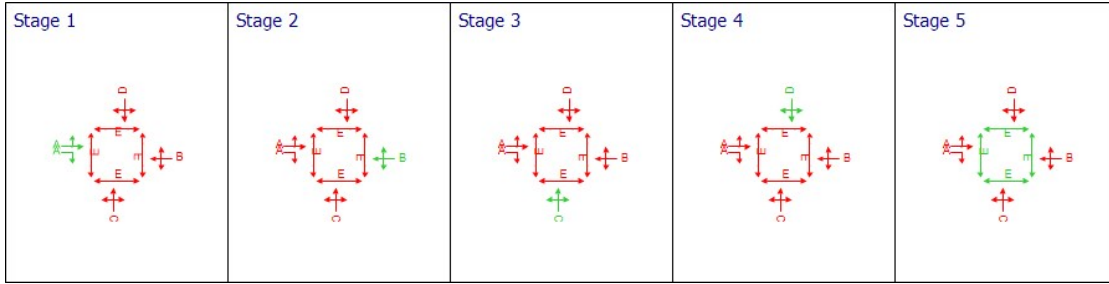

Resultant penalties

Time Segment	Controller stream	Phase min max penalty (£ per hr)	Intergreen broken penalty (£ per hr)	Stage constraint broken penalty (£ per hr)	Cost of controller stream penalties (£ per hr)
08:00-09:00	1	0.00	0.00	0.00	0.00

Traffic Stream Results

Traffic Stream Results: Vehicle summary

Time Segment	Arm	Traffic Stream	Degree of saturation (%)	Practical reserve capacity (%)	Calculated flow entering (Veh/hr)	Calculated sat flow (Veh/hr)	Actual green (s per cycle)	Mean Delay per Veh (s)	Mean max queue (Veh)	Utilised storage (%)	Weighted cost of delay (£ per hr)	Weighted cost of stops (£ per hr)	Performance Index (£ per hr)
08:00-09:00	A	1	83	21	535	1800	42	48.08	18.12	208.38	101.47	6.70	108.16
	Ax	1	0	Unrestricted	552	Unrestricted	120	0.00	0.00	0.00	0.00	0.00	0.00
	B	1	50	100	45	1800	5	74.91	1.69	19.46	13.30	0.63	13.92
	Bx	1	0	Unrestricted	61	Unrestricted	120	0.00	0.00	0.00	0.00	0.00	0.00
	C	1	86	17	501	1800	38	54.93	17.96	206.52	108.54	6.62	115.16
		2	2	5750	10	1800	38	27.73	0.23	2.59	1.09	0.08	1.18
	Cx	1	0	Unrestricted	494	Unrestricted	120	0.00	0.00	0.00	0.00	0.00	0.00
	D	1	36	181	32	1800	5	66.01	1.13	12.97	8.33	0.42	8.75
Dx	1	0	Unrestricted	16	Unrestricted	120	0.00	0.00	0.00	0.00	0.00	0.00	

Traffic Stream Results: Flows and signals

Time Segment	Arm	Traffic Stream	Calculated flow entering (Veh/hr)	Calculated flow out (Veh/hr)	Flow discrepancy (Veh/hr)	Adjusted flow warning	Calculated sat flow (Veh/hr)	Calculated capacity (Veh/hr)	Degree of saturation (%)	DOS Threshold exceeded	Practical reserve capacity (%)	Mean modulus of error	Actual green (s per cycle)
08:00-09:00	A	1	535	535	0		1800	645	83		21	0.00	42
	Ax	1	552	552	0		Unrestricted	Unrestricted	0		Unrestricted	1.05	120
	B	1	45	45	0		1800	90	50		100	0.00	5
	Bx	1	61	61	0		Unrestricted	Unrestricted	0		Unrestricted	0.94	120
	C	1	501	501	0		1800	585	86		17	0.00	38
		2	10	10	0		1800	585	2		5750	0.00	38
	Cx	1	494	494	0		Unrestricted	Unrestricted	0		Unrestricted	1.12	120
	D	1	32	32	0		1800	90	36		181	0.00	5
Dx	1	16	16	0		Unrestricted	Unrestricted	0		Unrestricted	0.62	120	

Traffic Stream Results: Stops and delays

Time Segment	Arm	Traffic Stream	Mean Cruise Time per Veh (s)	Mean Delay per Veh (s)	Uniform delay (Veh-hr/hr)	Random plus oversat delay (Veh-hr/hr)	Weighted cost of delay (£ per hr)	Mean stops per Veh (%)	Uniform stops (Stops per hr)	Random stops (Stops per hr)	Weighted cost of stops (£ per hr)
08:00-09:00	A	1	6.00	48.08	5.22	1.92	101.47	99.85	478.11	56.11	6.70
	Ax	1	16.50	0.00	0.00	0.00	0.00	0.00	0.00	0.00	0.00
	B	1	6.00	74.91	0.69	0.24	13.30	111.18	43.06	6.98	0.63
	Bx	1	16.59	0.00	0.00	0.00	0.00	0.00	0.00	0.00	0.00
	C	1	6.00	54.93	5.27	2.37	108.54	105.32	458.98	68.69	6.62
		2	6.00	27.73	0.08	0.00	1.09	66.56	6.65	0.00	0.08
	Cx	1	16.80	0.00	0.00	0.00	0.00	0.00	0.00	0.00	0.00
	D	1	6.00	66.01	0.49	0.10	8.33	104.41	30.58	2.83	0.42
Dx	1	16.45	0.00	0.00	0.00	0.00	0.00	0.00	0.00	0.00	

Traffic Stream Results: Queues and blocking

Time Segment	Arm	Traffic Stream	Initial queue (Veh)	Mean max queue (Veh)	Max queue storage (Veh)	Utilised storage (%)	Average storage excess queue (Veh)	Average limit excess queue (Veh)	Excess queue penalty (£ per hr)	Wasted time starvation (s per cycle)	Wasted time blocking back (s per cycle)	Wasted time total (s per cycle)	Estimated blocking
08:00-09:00	A	1	0.00	18.12	8.70	208.38	2.53	0.00	0.00	0.00	0.00	0.00	
	Ax	1	0.00	0.00	23.92	0.00	0.00	0.00	0.00	46.00	0.00	46.00	
	B	1	0.00	1.69	8.70	19.46	0.00	0.00	0.00	3.00	0.00	3.00	
	Bx	1	0.00	0.00	24.05	0.00	0.00	0.00	0.00	73.00	0.00	73.00	
	C	1	0.00	17.96	8.70	206.52	2.61	0.00	0.00	0.00	0.00	0.00	
		2	0.00	0.23	8.70	2.59	0.00	0.00	0.00	38.00	0.00	38.00	
	Cx	1	0.00	0.00	24.35	0.00	0.00	0.00	0.00	53.00	0.00	53.00	
	D	1	0.00	1.13	8.70	12.97	0.00	0.00	0.00	3.00	0.00	3.00	
Dx	1	0.00	0.00	23.84	0.00	0.00	0.00	0.00	120.00	0.00	120.00		

Pedestrian Crossing Results

Pedestrian Crossings: Pedestrian summary

Time Segment	Crossing	Side	Degree of saturation (%)	Calculated Flow Entering (Ped/hr)	Calculated sat flow (Ped/hr)	Actual green (s per cycle)	Mean Delay Per Ped (s)	Mean max queue (Ped)	Weighted cost of delay (£ per hr)	Performance Index (£ per hr)
08:00-09:00	(ALL)	(ALL)	7	30	11000	5	55.58	0.96	6.58	6.58

Pedestrian Crossings: Flows and signals

Time Segment	Crossing	Side	Calculated flow entering (Ped/hr)	Calculated flow out (Ped/hr)	Flow discrepancy (Ped/hr)	Adjusted flow warning	Calculated sat flow (Ped/hr)	Calculated capacity (Ped/hr)	Degree of saturation (%)	DOS Threshold exceeded	Practical reserve capacity (%)	Mean modulus of error	Actual green (s per cycle)
08:00-09:00	(ALL)	(ALL)	30	30	0		11000	458	7		1428	0.00	5

Pedestrian Crossings: Stops and delays

Time Segment	Crossing	Side	Mean Cruise Time per Ped (s)	Mean Delay per Ped (s)	Uniform delay (Ped-hr/hr)	Random plus oversat delay (Ped-hr/hr)	Weighted cost of delay (£ per hr)
08:00-09:00	1	1	5.67	55.58	0.46	0.00	6.58
		2	5.67	55.58	0.46	0.00	6.58
	2	1	6.33	55.58	0.46	0.00	6.58
		2	6.33	55.58	0.46	0.00	6.58
	3	1	6.33	55.58	0.46	0.00	6.58
		2	6.33	55.58	0.46	0.00	6.58
	4	1	5.67	55.58	0.46	0.00	6.58
		2	5.67	55.58	0.46	0.00	6.58

Pedestrian Crossings: Queues and blocking

Time Segment	Crossing	Side	Mean max queue (Ped)	Max queue storage (Ped)	Utilised storage (%)	Average storage excess queue (Ped)	Average limit excess queue (Ped)	Excess queue penalty (£ per hr)
08:00-09:00	(ALL)	(ALL)	0.96	10.00	9.58	0.00	0.00	0.00

Network Results

Network Results: Flows and signals

Time Segment	Calculated flow entering (Veh/hr)	Calculated flow out (Veh/hr)	Flow discrepancy (Veh/hr)	Adjusted flow warning	Degree of saturation (%)	DOS Threshold exceeded	Practical reserve capacity (%)	Actual green (s (per cycle))
08:00-09:00	2486	2486	0		86		17	648

Network Results: Stops and delays

Time Segment	Mean Cruise Time per Veh (s)	Mean Delay per Veh (s)	Uniform delay (Veh-hr/hr)	Random plus oversat delay (Veh-hr/hr)	Weighted cost of delay (£ per hr)	Mean stops per Veh (%)	Uniform stops (Stops per hr)	Random stops (Stops per hr)	Weighted cost of stops (£ per hr)
08:00-09:00	10.81	29.10	15.46	4.63	285.35	46.34	1017.38	134.61	14.44

Network Results: Queues and blocking

Time Segment	Utilised storage (%)	Excess queue penalty (£ per hr)	Wasted time starvation (s (per cycle))	Wasted time blocking back (s (per cycle))	Wasted time total (s (per cycle))
08:00-09:00	208.38	0.00	336.00	0.00	336.00

Final Prediction Table

Traffic Stream Results

Arm	Traffic Stream	Name	Traffic node	SIGNALS		FLOWS		PERFORMANCE				PER PCU			QUEUES
				Controller stream	Phase	Calculated flow entering (Veh/hr)	Calculated sat flow (Veh/hr)	Actual green (s (per cycle))	Wasted time total (s (per cycle))	Degree of saturation (%)	Practical reserve capacity (%)	JourneyTime (s)	Mean Delay per Veh (s)	Mean stops per Veh (%)	Mean max queue (Veh)
A	1	(untitled)	1	1	B	535 <	1800	42	0.00	83	21	54.08	48.08	99.85	18.12 +
Ax	1	(untitled)				552	Unrestricted	120	46.00	0	Unrestricted	16.50	0.00	0.00	0.00
B	1	(untitled)	1	1	C	45	1800	5	3.00	50	100	80.91	74.91	111.18	1.69
Bx	1	(untitled)				61	Unrestricted	120	73.00	0	Unrestricted	16.59	0.00	0.00	0.00
C	1	(untitled)	1	1	A	501 <	1800	38	0.00	86	17	60.93	54.93	105.32	17.96 +
	2	(untitled)	1	1	A	10	1800	38	38.00	2	5750	33.73	27.73	66.56	0.23
Cx	1	(untitled)				494	Unrestricted	120	53.00	0	Unrestricted	16.80	0.00	0.00	0.00
D	1	(untitled)	1	1	D	32	1800	5	3.00	36	181	72.01	66.01	104.41	1.13
Dx	1	(untitled)				16	Unrestricted	120	120.00	0	Unrestricted	16.45	0.00	0.00	0.00

Pedestrian Crossing Results

Pedestrian	Side	Name	Traffic node	SIGNALS		FLOWS		PERFORMANCE			PER PED		QUEUES	WEIGHTS	PEN
				Controller stream	Phase	Calculated Flow Entering (Ped/hr)	Calculated sat flow (Ped/hr)	Actual green (s (per cycle))	Degree of saturation (%)	Practical reserve capacity (%)	JourneyTime (s)	Mean Delay per Ped (s)	Mean max queue (Ped)	Delay weighting (%)	Co tra pen (£ p
1	1	(untitled)	1	1	E	30	11000	5	7	1428	61.25	55.58	0.96	100	0
	2	(untitled)	1	1	E	30	11000	5	7	1428	61.25	55.58	0.96	100	0
2	1	(untitled)	1	1	E	30	11000	5	7	1428	61.92	55.58	0.96	100	0
	2	(untitled)	1	1	E	30	11000	5	7	1428	61.92	55.58	0.96	100	0
3	1	(untitled)	1	1	E	30	11000	5	7	1428	61.92	55.58	0.96	100	0
	2	(untitled)	1	1	E	30	11000	5	7	1428	61.92	55.58	0.96	100	0
4	1	(untitled)	1	1	E	30	11000	5	7	1428	61.25	55.58	0.96	100	0
	2	(untitled)	1	1	E	30	11000	5	7	1428	61.25	55.58	0.96	100	0

Network Results

	Distance travelled (PCU-km/hr)	Time spent (PCU-hr/hr)	Mean journey speed (kph)	Uniform delay (Veh-hr/hr)	Random plus oversat delay (Veh-hr/hr)	Weighted cost of delay (£ per hr)	Weighted cost of stops (£ per hr)	Excess queue penalty (£ per hr)	Performance Index (£ per hr)
Normal traffic	211.85	23.45	9.03	11.76	4.63	232.73	14.44	0.00	247.18
Bus									
Tram									
Pedestrians	2.04	4.11	0.50	3.71	0.00	52.62	0.00	0.00	52.62
TOTAL	213.89	27.56	7.76	15.46	4.63	285.35	14.44	0.00	299.80

- | < = adjusted flow warning (upstream links/traffic streams are over-saturated)
- | * = Traffic Stream - Normal, Bus or Tram Stop or Delay weighting has been set to a value other than 100%
- | ^ = Traffic Stream - Normal, Bus or Tram Stop or Delay Path weighting has been set to a value other than 100%
- | + = average link/traffic stream excess queue is greater than 0
- | **P.I. = PERFORMANCE INDEX**



<h1>TRANSYT 16</h1>
Version: 16.0.1.8473 © Copyright TRL Limited, 2019
For sales and distribution information, program advice and maintenance, contact TRL: +44 (0)1344 379777 software@trl.co.uk www.trisoftware.co.uk
The users of this computer program for the solution of an engineering problem are in no way relieved of their responsibility for the correctness of the solution

Filename: Junction 4 - PM.t16

Path: M:\Projects\12\12-081A - Dunshaughlin Phase 2 - Civils\Design\Traffic\Modelling SEPTEMBER 2020\Option 2 - South Site - Two Separate Areas\Junction 4

Report generation date: 18/09/2020 14:29:25

»Network Diagrams

«A6 - DO SOMETHING 2039 - Assessment Layout Option 2 : D6 - DO SOMETHING 2039, :

»Summary

»Arms and Traffic Streams

»Pedestrian Crossings

»Local OD Matrix - Local Matrix: 1

»Signal Timings

»Traffic Stream Results

»Pedestrian Crossing Results

»Network Results

»Final Prediction Table

Summary of network performance

	PI (£ per hr)	Total delay (Veh-hr/hr)	Highest DOS	Number oversaturated
DO SOMETHING 2039 - Assessment Layout Option 2 - DO SOMETHING 2039				
Network	238.42	15.97	75% (TS C/1)	0 (0%)

File summary

File description

File title	(untitled)
Location	
Site number	
UTCRegion	
Driving side	Left
Date	06/12/2011
Version	
Status	(new file)
Identifier	
Client	
Jobnumber	
Enumerator	DOMAINf.silva
Description	

Model and Results

Enable controller offsets	Enable fuel consumption	Enable quick flares	Display journey time results	Display OD matrix distances	Display level of service results	Display blocking and starvation results	Display end of red and green queue results	Display excess queue results	Display separate uniform and random results	Display unweighted results	Display TRANSYT 12 style timings	Display effective greens in results	Display Red-With-Amber	Display End-Of-Green Amber	c
			✓			✓		✓	✓						m

Units

Cost units	Speed units	Distance units	Fuel economy units	Fuel rate units	Mass units	Traffic units input	Traffic units results	Flow units	Average delay units	Total delay units	Rate of delay units
£	kph	m	mpg	l/h	kg	Veh	Veh	perHour	s	-Hour	perHour

Sorting

Show names instead of IDs	Sorting direction	Sorting type	Ignore prefixes when sorting	Analysis/demand set sorting	Link grouping	Source grouping	Colour Analysis/Demand Sets
	Ascending	Numerical		ID	Normal	Normal	✓

Simulation options

Criteria type	Stop criteria (%)	Stop criteria time (s)	Stop criteria number of trials	Random seed	Results refresh speed (s)	Average animation capture interval (s)	Use quick response	Do flow sampling	Uniform vehicle generation	Last run random seed	Last run number of trials	Last run time taken (s)
Delay	3.00	999	200	-1	3	60	✓			0	0	0.00

Network Diagrams

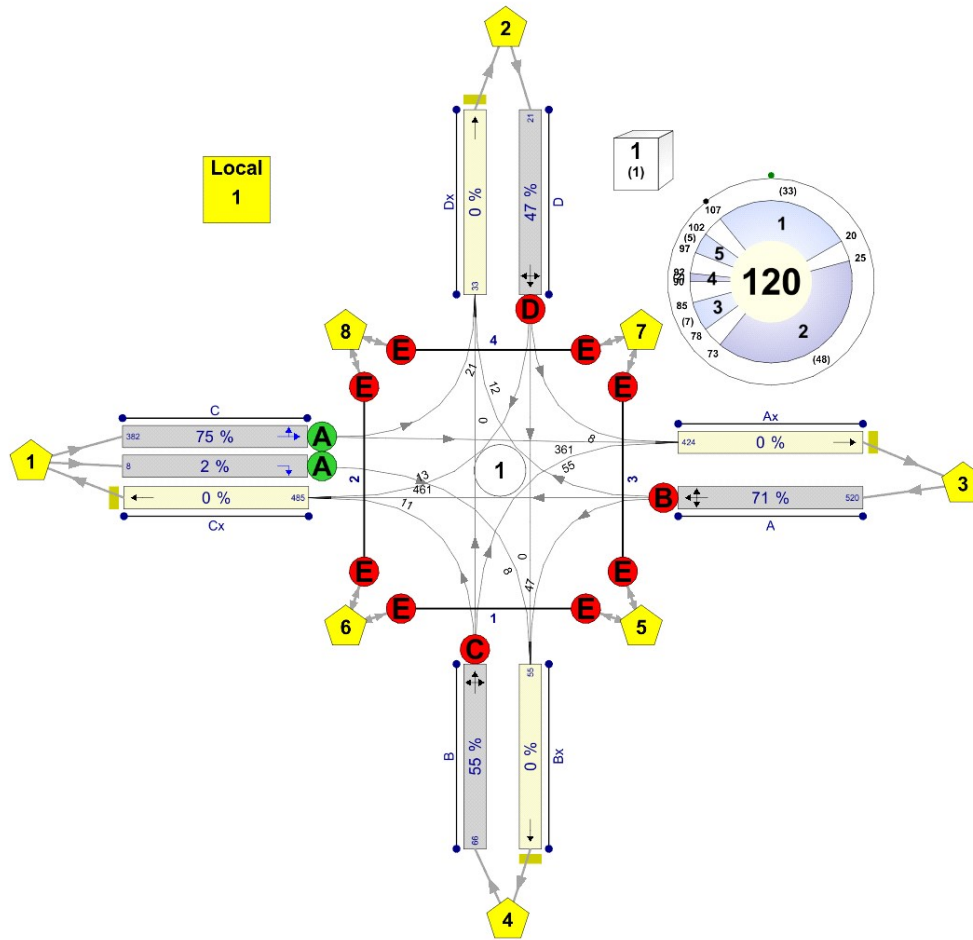

(untitled)
Diagram produced using TRANSYT 16.0.1.8473

A6 - DO SOMETHING 2039 - Assessment Layout Option 2

D6 - DO SOMETHING 2039,

Summary

Data Errors and Warnings
No errors or warnings

Run Summary

Analysis set used	Run start time	Run finish time	Run duration (s)	Modelling start time (HH:mm)	Network Cycle Time (s)	Performance Index (£ per hr)	Total network delay (Veh-hr/hr)	Highest DOS (%)	Item with highest DOS	Number of oversaturated items	Percentage of oversaturated items (%)	Item with worst signalised PRC	Item with worst unsignal PRC
6	18/09/2020 14:29:17	18/09/2020 14:29:20	3.54	17:00	120	238.42	15.97	74.90	C/1	0	0	C/1	Dx/1

Analysis Set Details

Name	Use Simulation	Description	Use specific Demand Set(s)	Specific Demand Set(s)	Optimise specific Demand Set(s)	Include in report	Locked
DO SOMETHING 2039 - Assessment Layout Option 2		PM	✓	D6		✓	

Demand Set Details

Scenario name	Time Period name	Description	Composite	Demand sets	Start time (HH:mm)	Locked	Run automatically
DO SOMETHING 2039		PM			17:00		✓

Arms and Traffic Streams

Arms

Arm	Name	Description	Traffic node
A	(untitled)		1
Ax	(untitled)		
B	(untitled)		1
Bx	(untitled)		
C	(untitled)		1
Cx	(untitled)		
D	(untitled)		1
Dx	(untitled)		

Traffic Streams

Arm	Traffic Stream	Name	Description	Auto length	Length (m)	Has Saturation Flow	Saturation flow source	Saturation flow (PCU/hr)	Is signal controlled	Is give way	Traffic type	Allow Nearside Turn On Red
A	1	(untitled)		✓	50.00	✓	Sum of lanes	1800	✓		Normal	
Ax	1	(untitled)		✓	137.53						Normal	
B	1	(untitled)		✓	50.00	✓	Sum of lanes	1800	✓		Normal	
Bx	1	(untitled)		✓	138.27						Normal	
C	1	(untitled)		✓	50.00	✓	Sum of lanes	1800	✓		Normal	
	2	(untitled)		✓	50.00	✓	Sum of lanes	1800	✓		Normal	
Cx	1	(untitled)		✓	140.00						Normal	
D	1	(untitled)		✓	50.00	✓	Sum of lanes	1800	✓		Normal	
Dx	1	(untitled)		✓	137.05						Normal	

Lanes

Arm	Traffic Stream	Lane	Name	Description	Use RR67	Saturation flow (PCU/hr)
A	1	1	(untitled)			1800
Ax	1	1	(untitled)			
B	1	1	(untitled)			1800
Bx	1	1	(untitled)			
C	1	1	(untitled)			1800
	2	1	(untitled)			1800
Cx	1	1	(untitled)			
D	1	1	(untitled)			1800
Dx	1	1	(untitled)			

Modelling

Arm	Traffic Stream	Traffic model	Stop weighting multiplier (%)	Delay weighting multiplier (%)	Assignment Cost Weighting (%)	Exclude from results calculation	Max queue storage (PCU)	Has queue limit	Has degree of saturation limit
(ALL)	(ALL)	NetworkDefault	100	100	100		0.00		

Modelling - Advanced

Arm	Traffic Stream	Initial queue (PCU)	Type of Vehicle-in-Service	Vehicle-in-Service	Type of random parameter	Random parameter	Auto cycle time	Cycle time
(ALL)	(ALL)	0.00	NetworkDefault	Not-Included	NetworkDefault	0.50	✓	120

Normal traffic - Modelling

Arm	Traffic Stream	Stop weighting (%)	Delay weighting (%)
(ALL)	(ALL)	100	100

Normal traffic - Advanced

Arm	Traffic Stream	Dispersion type for Normal Traffic
(ALL)	(ALL)	NetworkDefault

Flows

Arm	Traffic Stream	Total Flow (Veh/hr)	Normal Flow (Veh/hr)
A	1	520	520
Ax	1	424	424
B	1	66	66
Bx	1	55	55
C	1	382	382
	2	8	8
Cx	1	485	485
D	1	21	21
Dx	1	33	33

Signals

Arm	Traffic Stream	Controller stream	Phase	Second phase enabled
A	1	1	B	
B	1	1	C	
C	1	1	A	
	2	1	A	
D	1	1	D	

Pedestrian Crossings

Pedestrian Crossings

Crossing	Name	Description	Traffic node	Allow walk on red	Crossing type	Length (m)	Cruise time (seconds)	Cruise speed (kph)
1	(untitled)		1		Farside	7.00	4.67	5.40
2	(untitled)		1		Farside	8.00	5.33	5.40
3	(untitled)		1		Farside	8.00	5.33	5.40
4	(untitled)		1		Farside	7.00	4.67	5.40

Pedestrian Crossings - Signals

Crossing	Controller stream	Phase	Second phase enabled
(ALL)	1	E	

Pedestrian Crossings - Sides

Crossing	Side	Saturation flow (Ped/hr)
(ALL)	(ALL)	11000

Pedestrian Crossings - Modelling

Crossing	Side	Delay weighting (%)	Assignment Cost Weighting (%)	Exclude from results calculation	Max queue storage (Ped)	Has queue limit	Has degree of saturation limit
(ALL)	(ALL)	100	100		0.00		

Local OD Matrix - Local Matrix: 1

Local Matrix Options

OD Matrix	Name	Use for point to point table	Auto calculate	Allocation mode	Allow paths past exit locations	Allow looped paths on arms	Allow looped paths on traffic nodes	Copy flows	Matrix to copy flows from	Limit paths by length	Path length limit multiplier	Limit paths by number	Path number limit	Limit paths by flow	Low path flow threshold
1	(untitled)	✓	✓	Path Equalisation	✓		✓			✓	1.25				

Normal Input Flows (Veh/hr)

		To							
		1	2	3	4	5	6	7	8
From	1	0	21	361	8	0	0	0	0
	2	13	0	8	0	0	0	0	0
	3	461	12	0	47	0	0	0	0
	4	11	0	55	0	0	0	0	0
	5	0	0	0	0	0	0	0	0
	6	0	0	0	0	0	0	0	0
	7	0	0	0	0	0	0	0	0
	8	0	0	0	0	0	0	0	0

Bus Input Flows not shown as they are blank.

Tram Input Flows not shown as they are blank.

Pedestrian Input Flows (Veh/hr)

From	To							
	1	2	3	4	5	6	7	8
1	0	0	0	0	0	0	0	0
2	0	0	0	0	0	0	0	0
3	0	0	0	0	0	0	0	0
4	0	0	0	0	0	0	0	0
5	0	0	0	0	0	30	30	0
6	0	0	0	0	30	0	0	30
7	0	0	0	0	30	0	0	30
8	0	0	0	0	0	30	30	0

Locations

OD Matrix	Location	Name	Entries	Exits	Colour
1	1	(untitled)	C/1, C/2	Cx/1	#0000FF
	2	(untitled)	D/1	Dx/1	#FF0000
	3	(untitled)	A/1	Ax/1	#00FF00
	4	(untitled)	B/1	Bx/1	#FFFF00
	5	(untitled)	3:2E, 1:1E	3:2X, 1:1X	#FF00FF
	6	(untitled)	2:1E, 1:2E	2:1X, 1:2X	#008000
	7	(untitled)	4:2E, 3:1E	4:2X, 3:1X	#FFA500
	8	(untitled)	4:1E, 2:2E	4:1X, 2:2X	#00FFFF

Normal Paths and Flows

OD Matrix	Path	Description	From location	To location	Path items	Allocation type	Normal Calculated Flow (Veh/hr)
1	1		1	2	C/1, Dx/1	Normal	21
	2		1	3	C/1, Ax/1	Normal	361
	5		2	3	D/1, Ax/1	Normal	8
	6		2	4	D/1, Bx/1	Normal	0
	7		2	1	D/1, Cx/1	Normal	13
	8		3	2	A/1, Dx/1	Normal	12
	9		3	4	A/1, Bx/1	Normal	47
	10		3	1	A/1, Cx/1	Normal	461
	11		4	2	B/1, Dx/1	Normal	0
	12		4	3	B/1, Ax/1	Normal	55
	13		4	1	B/1, Cx/1	Normal	11
	21		1	4	C/2, Bx/1	Normal	8

Pedestrian Paths and Flows

OD Matrix	Path	Description	From location	To location	Path items	Allocation type	Pedestrian calculated flow (Ped/hr)
1	17		8	7	4:1E, 4:2X	Normal	30
	18		8	6	2:2E, 2:1X	Normal	30
	22		5	7	3:2E, 3:1X	Normal	30
	23		5	6	1:1E, 1:2X	Normal	30
	34		6	8	2:1E, 2:2X	Normal	30
	35		6	5	1:2E, 1:1X	Normal	30
	41		7	8	4:2E, 4:1X	Normal	30
	42		7	5	3:1E, 3:2X	Normal	30

Signal Timings

Network Default: 120s cycle time; 120 steps

Controller Stream 1

Controller Stream	Name	Description	Use sequence	Cycle time source	Cycle time (s)	Minimum possible cycle time (s)
1	(untitled)		1	NetworkDefault	120	34

Controller Stream 1 - Properties

Controller Stream	Manufacturer name	Type	Model number	(Telephone) Line Number	Site number	Grid reference	Gaining delay type
1	Unspecified						Relative

Controller Stream 1 - Optimisation

Controller Stream	Allow offset optimisation	Allow green split optimisation	Optimisation level	Auto redistribute	Enable stage constraint
1	✓	✓	Offsets And Green Splits	✓	

Phases

Controller Stream	Phase	Name	Street minimum green (s)	Maximum green (s)	Relative start displacement (s)	Relative end displacement (s)	Type	Blackout Time (s)
1	A	(untitled)	0	300	0	0	Traffic	
	B	(untitled)	0	300	0	0	Traffic	
	C	(untitled)	0	300	0	0	Traffic	
	D	(untitled)	0	5	0	0	Traffic	
	E	(untitled)	5	5	0	0	Pedestrian	0

Library Stages

Controller Stream	Library Stage	Phases in stage	User stage minimum (s)	Run every N cycles	Probability of running (%)
1	1	A	1	1	100
	2	B	1	1	100
	3	C	1	1	100
	4	D	1	1	100
	5	E	1	1	100

Stage Sequences

Controller Stream	Sequence	Name	Multiple cycling	Stage IDs	Stage ends	Minimum possible cycle time (s)	Exclude from analysis
1	1	(untitled)	Single	1, 2, 3, 4, 5	20, 73, 85, 92, 102	34	

Intergreen Matrix for Controller Stream 1

		To				
		A	B	C	D	E
From	A		5	5	5	5
	B	5		5	5	5
	C	5	5		5	5
	D	5	5	5		5
	E	5	5	5	5	

Banned Stage transitions for Controller Stream 1

		To				
		1	2	3	4	5
From	1					
	2					
	3					
	4					
	5					

Interstage Matrix for Controller Stream 1

From	To				
	1	2	3	4	5
1	0	5	5	5	5
2	5	0	5	5	5
3	5	5	0	5	5
4	5	5	5	0	5
5	5	5	5	5	0

Resultant Stages

Controller Stream	Resultant Stage	Is base stage	Library Stage ID	Phases in this stage	Stage start (s)	Stage end (s)	Stage duration (s)	User stage minimum (s)	Stage minimum (s)
1	1	✓	1	A	107	20	33	1	1
	2	✓	2	B	25	73	48	1	1
	3	✓	3	C	78	85	7	1	1
	4	✓	4	D	90	92	2	1	1
	5	✓	5	E	97	102	5	1	5

Resultant Phase Green Periods

Controller Stream	Phase	Green period	Is base green period	Start time (s)	End time (s)	Duration (s)
1	A	1	✓	107	20	33
	B	1	✓	25	73	48
	C	1	✓	78	85	7
	D	1	✓	90	92	2
	E	1	✓	97	102	5

Traffic Stream Green Times

Arm	Traffic Stream	Traffic Node	Controller Stream	Phase	Green Period 1		
					Start	End	Duration
A	1	1	1	B	25	73	48
B	1	1	1	C	78	85	7
C	1	1	1	A	107	20	33
C	2	1	1	A	107	20	33
D	1	1	1	D	90	92	2

Phase Timings Diagram for Controller Stream 1

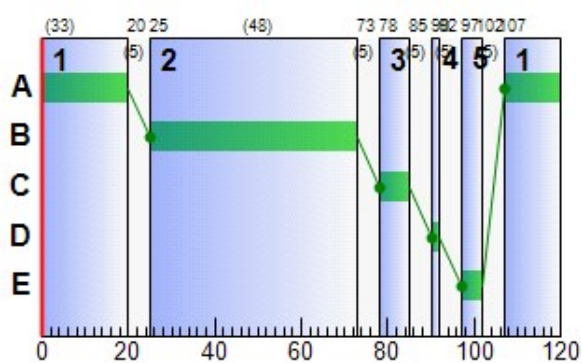

Stage Sequence Diagram for Controller Stream 1

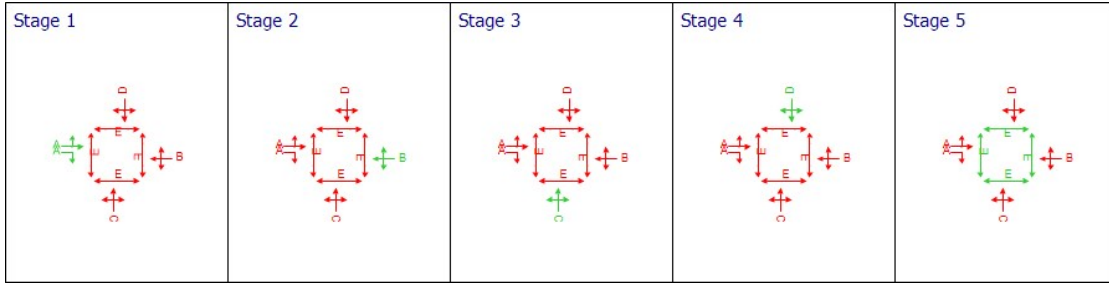

Resultant penalties

Time Segment	Controller stream	Phase min max penalty (£ per hr)	Intergreen broken penalty (£ per hr)	Stage constraint broken penalty (£ per hr)	Cost of controller stream penalties (£ per hr)
17:00-18:00	1	0.00	0.00	0.00	0.00

Traffic Stream Results

Traffic Stream Results: Vehicle summary

Time Segment	Arm	Traffic Stream	Degree of saturation (%)	Practical reserve capacity (%)	Calculated flow entering (Veh/hr)	Calculated sat flow (Veh/hr)	Actual green (s per cycle)	Mean Delay per Veh (s)	Mean max queue (Veh)	Utilised storage (%)	Weighted cost of delay (£ per hr)	Weighted cost of stops (£ per hr)	Performance Index (£ per hr)
17:00-18:00	A	1	71	41	520	1800	48	35.38	15.14	174.15	72.56	5.61	78.17
	Ax	1	0	Unrestricted	424	Unrestricted	120	0.00	0.00	0.00	0.00	0.00	0.00
	B	1	55	82	66	1800	7	72.04	2.45	28.20	18.75	0.91	19.66
	Bx	1	0	Unrestricted	55	Unrestricted	120	0.00	0.00	0.00	0.00	0.00	0.00
	C	1	75	34	382	1800	33	49.36	12.65	145.51	74.38	4.67	79.05
		2	2	6275	8	1800	33	31.23	0.19	2.20	0.99	0.07	1.06
	Cx	1	0	Unrestricted	485	Unrestricted	120	0.00	0.00	0.00	0.00	0.00	0.00
	D	1	47	114	21	1800	2	90.98	0.88	10.14	7.54	0.32	7.86
Dx	1	0	Unrestricted	33	Unrestricted	120	0.00	0.00	0.00	0.00	0.00	0.00	

Traffic Stream Results: Flows and signals

Time Segment	Arm	Traffic Stream	Calculated flow entering (Veh/hr)	Calculated flow out (Veh/hr)	Flow discrepancy (Veh/hr)	Adjusted flow warning	Calculated sat flow (Veh/hr)	Calculated capacity (Veh/hr)	Degree of saturation (%)	DOS Threshold exceeded	Practical reserve capacity (%)	Mean modulus of error	Actual green (s per cycle)
17:00-18:00	A	1	520	520	0		1800	735	71		41	0.00	48
	Ax	1	424	424	0		Unrestricted	Unrestricted	0		Unrestricted	1.10	120
	B	1	66	66	0		1800	120	55		82	0.00	7
	Bx	1	55	55	0		Unrestricted	Unrestricted	0		Unrestricted	0.89	120
	C	1	382	382	0		1800	510	75		34	0.00	33
		2	8	8	0		1800	510	2		6275	0.00	33
	Cx	1	485	485	0		Unrestricted	Unrestricted	0		Unrestricted	1.01	120
	D	1	21	21	0		1800	45	47		114	0.00	2
Dx	1	33	33	0		Unrestricted	Unrestricted	0		Unrestricted	0.73	120	

Traffic Stream Results: Stops and delays

Time Segment	Arm	Traffic Stream	Mean Cruise Time per Veh (s)	Mean Delay per Veh (s)	Uniform delay (Veh-hr/hr)	Random plus oversat delay (Veh-hr/hr)	Weighted cost of delay (£ per hr)	Mean stops per Veh (%)	Uniform stops (Stops per hr)	Random stops (Stops per hr)	Weighted cost of stops (£ per hr)
17:00-18:00	A	1	6.00	35.38	4.27	0.84	72.56	85.99	422.17	25.00	5.61
	Ax	1	16.50	0.00	0.00	0.00	0.00	0.00	0.00	0.00	0.00
	B	1	6.00	72.04	1.00	0.33	18.75	109.93	63.14	9.41	0.91
	Bx	1	16.59	0.00	0.00	0.00	0.00	0.00	0.00	0.00	0.00
	C	1	6.00	49.36	4.15	1.09	74.38	97.56	340.78	31.91	4.67
		2	6.00	31.23	0.07	0.00	0.99	70.73	5.65	0.00	0.07
	Cx	1	16.80	0.00	0.00	0.00	0.00	0.00	0.00	0.00	0.00
	D	1	6.00	90.98	0.34	0.19	7.54	123.18	20.44	5.42	0.32
Dx	1	16.45	0.00	0.00	0.00	0.00	0.00	0.00	0.00	0.00	

Traffic Stream Results: Queues and blocking

Time Segment	Arm	Traffic Stream	Initial queue (Veh)	Mean max queue (Veh)	Max queue storage (Veh)	Utilised storage (%)	Average storage excess queue (Veh)	Average limit excess queue (Veh)	Excess queue penalty (£ per hr)	Wasted time starvation (s per cycle)	Wasted time blocking back (s per cycle)	Wasted time total (s per cycle)	Estimated blocking	
17:00-18:00	A	1	0.00	15.14	8.70	174.15	1.23	0.00	0.00	0.00	0.00	0.00		
	Ax	1	0.00	0.00	23.92	0.00	0.00	0.00	0.00	54.00	0.00	54.00		
	B	1	0.00	2.45	8.70	28.20	0.00	0.00	0.00	0.00	0.00	0.00		
	Bx	1	0.00	0.00	24.05	0.00	0.00	0.00	0.00	77.00	0.00	77.00		
	C	1	0.00	12.65	8.70	145.51	0.63	0.00	0.00	0.00	0.00	0.00	0.00	
		2	0.00	0.19	8.70	2.20	0.00	0.00	0.00	0.00	33.00	0.00	33.00	
	Cx	1	0.00	0.00	24.35	0.00	0.00	0.00	0.00	45.00	0.00	45.00		
	D	1	0.00	0.88	8.70	10.14	0.00	0.00	0.00	1.00	0.00	1.00		
Dx	1	0.00	0.00	23.84	0.00	0.00	0.00	0.00	98.00	0.00	98.00			

Pedestrian Crossing Results

Pedestrian Crossings: Pedestrian summary

Time Segment	Crossing	Side	Degree of saturation (%)	Calculated Flow Entering (Ped/hr)	Calculated sat flow (Ped/hr)	Actual green (s per cycle)	Mean Delay Per Ped (s)	Mean max queue (Ped)	Weighted cost of delay (£ per hr)	Performance Index (£ per hr)
17:00-18:00	(ALL)	(ALL)	7	30	11000	5	55.58	0.96	6.58	6.58

Pedestrian Crossings: Flows and signals

Time Segment	Crossing	Side	Calculated flow entering (Ped/hr)	Calculated flow out (Ped/hr)	Flow discrepancy (Ped/hr)	Adjusted flow warning	Calculated sat flow (Ped/hr)	Calculated capacity (Ped/hr)	Degree of saturation (%)	DOS Threshold exceeded	Practical reserve capacity (%)	Mean modulus of error	Actual green (s per cycle)
17:00-18:00	(ALL)	(ALL)	30	30	0		11000	458	7		1428	0.00	5

Pedestrian Crossings: Stops and delays

Time Segment	Crossing	Side	Mean Cruise Time per Ped (s)	Mean Delay per Ped (s)	Uniform delay (Ped-hr/hr)	Random plus oversat delay (Ped-hr/hr)	Weighted cost of delay (£ per hr)
17:00-18:00	1	1	5.67	55.58	0.46	0.00	6.58
		2	5.67	55.58	0.46	0.00	6.58
	2	1	6.33	55.58	0.46	0.00	6.58
		2	6.33	55.58	0.46	0.00	6.58
	3	1	6.33	55.58	0.46	0.00	6.58
		2	6.33	55.58	0.46	0.00	6.58
	4	1	5.67	55.58	0.46	0.00	6.58
		2	5.67	55.58	0.46	0.00	6.58

Pedestrian Crossings: Queues and blocking

Time Segment	Crossing	Side	Mean max queue (Ped)	Max queue storage (Ped)	Utilised storage (%)	Average storage excess queue (Ped)	Average limit excess queue (Ped)	Excess queue penalty (£ per hr)
17:00-18:00	(ALL)	(ALL)	0.96	10.00	9.58	0.00	0.00	0.00

Network Results

Network Results: Flows and signals

Time Segment	Calculated flow entering (Veh/hr)	Calculated flow out (Veh/hr)	Flow discrepancy (Veh/hr)	Adjusted flow warning	Degree of saturation (%)	DOS Threshold exceeded	Practical reserve capacity (%)	Actual green (s (per cycle))
17:00-18:00	2234	2234	0		75		34	643

Network Results: Stops and delays

Time Segment	Mean Cruise Time per Veh (s)	Mean Delay per Veh (s)	Uniform delay (Veh-hr/hr)	Random plus oversat delay (Veh-hr/hr)	Weighted cost of delay (£ per hr)	Mean stops per Veh (%)	Uniform stops (Stops per hr)	Random stops (Stops per hr)	Weighted cost of stops (£ per hr)
17:00-18:00	10.75	25.74	13.52	2.45	226.83	41.36	852.19	71.75	11.58

Network Results: Queues and blocking

Time Segment	Utilised storage (%)	Excess queue penalty (£ per hr)	Wasted time starvation (s (per cycle))	Wasted time blocking back (s (per cycle))	Wasted time total (s (per cycle))
17:00-18:00	174.15	0.00	308.00	0.00	308.00

Final Prediction Table

Traffic Stream Results

Arm	Traffic Stream	Name	Traffic node	SIGNALS		FLOWS		PERFORMANCE				PER PCU			QUEUES
				Controller stream	Phase	Calculated flow entering (Veh/hr)	Calculated sat flow (Veh/hr)	Actual green (s (per cycle))	Wasted time total (s (per cycle))	Degree of saturation (%)	Practical reserve capacity (%)	JourneyTime (s)	Mean Delay per Veh (s)	Mean stops per Veh (%)	Mean max queue (Veh)
A	1	(untitled)	1	1	B	520 <	1800	48	0.00	71	41	41.38	35.38	85.99	15.14 +
Ax	1	(untitled)				424	Unrestricted	120	54.00	0	Unrestricted	16.50	0.00	0.00	0.00
B	1	(untitled)	1	1	C	66	1800	7	0.00	55	82	78.04	72.04	109.93	2.45
Bx	1	(untitled)				55	Unrestricted	120	77.00	0	Unrestricted	16.59	0.00	0.00	0.00
C	1	(untitled)	1	1	A	382 <	1800	33	0.00	75	34	55.36	49.36	97.56	12.65 +
	2	(untitled)	1	1	A	8	1800	33	33.00	2	6275	37.23	31.23	70.73	0.19
Cx	1	(untitled)				485	Unrestricted	120	45.00	0	Unrestricted	16.80	0.00	0.00	0.00
D	1	(untitled)	1	1	D	21	1800	2	1.00	47	114	96.98	90.98	123.18	0.88
Dx	1	(untitled)				33	Unrestricted	120	98.00	0	Unrestricted	16.45	0.00	0.00	0.00

Pedestrian Crossing Results

Pedestrian	Side	Name	Traffic node	SIGNALS		FLOWS		PERFORMANCE			PER PED		QUEUES	WEIGHTS	PEN
				Controller stream	Phase	Calculated Flow Entering (Ped/hr)	Calculated sat flow (Ped/hr)	Actual green (s (per cycle))	Degree of saturation (%)	Practical reserve capacity (%)	JourneyTime (s)	Mean Delay per Ped (s)	Mean max queue (Ped)	Delay weighting (%)	Co tra pen (£ p
1	1	(untitled)	1	1	E	30	11000	5	7	1428	61.25	55.58	0.96	100	0
	2	(untitled)	1	1	E	30	11000	5	7	1428	61.25	55.58	0.96	100	0
2	1	(untitled)	1	1	E	30	11000	5	7	1428	61.92	55.58	0.96	100	0
	2	(untitled)	1	1	E	30	11000	5	7	1428	61.92	55.58	0.96	100	0
3	1	(untitled)	1	1	E	30	11000	5	7	1428	61.92	55.58	0.96	100	0
	2	(untitled)	1	1	E	30	11000	5	7	1428	61.92	55.58	0.96	100	0
4	1	(untitled)	1	1	E	30	11000	5	7	1428	61.25	55.58	0.96	100	0
	2	(untitled)	1	1	E	30	11000	5	7	1428	61.25	55.58	0.96	100	0

Network Results

	Distance travelled (PCU-km/hr)	Time spent (PCU-hr/hr)	Mean journey speed (kph)	Uniform delay (Veh-hr/hr)	Random plus oversat delay (Veh-hr/hr)	Weighted cost of delay (£ per hr)	Weighted cost of stops (£ per hr)	Excess queue penalty (£ per hr)	Performance Index (£ per hr)
Normal traffic	188.19	18.54	10.15	9.82	2.45	174.21	11.58	0.00	185.80
Bus									
Tram									
Pedestrians	2.04	4.11	0.50	3.71	0.00	52.62	0.00	0.00	52.62
TOTAL	190.23	22.65	8.40	13.52	2.45	226.83	11.58	0.00	238.42

- | < = adjusted flow warning (upstream links/traffic streams are over-saturated)
- | * = Traffic Stream - Normal, Bus or Tram Stop or Delay weighting has been set to a value other than 100%
- | ^ = Traffic Stream - Normal, Bus or Tram Stop or Delay Path weighting has been set to a value other than 100%
- | + = average link/traffic stream excess queue is greater than 0
- | **P.I. = PERFORMANCE INDEX**



Junctions 9
ARCADY 9 - Roundabout Module
Version: 9.5.1.7462 © Copyright TRL Limited, 2019
For sales and distribution information, program advice and maintenance, contact TRL: +44 (0)1344 379777 software@trl.co.uk www.trlsoftware.co.uk
The users of this computer program for the solution of an engineering problem are in no way relieved of their responsibility for the correctness of the solution

Filename: Junction 5 - AM-PM.j9

Path: M:\Projects\12\12-081A - Dunshaughlin Phase 2 - Civils\Design\Traffic\Modelling SEPTEMBER 2020\Option 2 - South Site - Two Separate Areas\Junction 5

Report generation date: 18/09/2020 14:31:55

»JUNCTION 5 - Assessment Layout Option 2 - DO SOMETHING 2039, AM

»JUNCTION 5 - Assessment Layout Option 2 - DO SOMETHING 2039, PM

Summary of junction performance

	AM					PM				
	Set ID	Queue (Veh)	Delay (s)	RFC	LOS	Set ID	Queue (Veh)	Delay (s)	RFC	LOS
JUNCTION 5 - Assessment Layout Option 2 - DO SOMETHING 2039										
Arm 1	D13	0.1	3.05	0.10	A	D14	0.2	3.02	0.14	A
Arm 2		0.6	3.14	0.36	A		0.6	3.17	0.36	A
Arm 3		0.0	0.00	0.00	A		0.0	0.00	0.00	A
Arm 4		0.5	3.19	0.33	A		0.4	2.87	0.26	A

Values shown are the highest values encountered over all time segments. Delay is the maximum value of average delay per arriving vehicle.

File summary

File Description

Title	
Location	
Site number	
Date	04/03/2020
Version	
Status	(new file)
Identifier	
Client	
Jobnumber	
Enumerator	DOMAINf.silva
Description	

Units

Distance units	Speed units	Traffic units input	Traffic units results	Flow units	Average delay units	Total delay units	Rate of delay units
m	kph	Veh	Veh	perHour	s	-Min	perMin

Analysis Options

Calculate Queue Percentiles	Calculate residual capacity	RFC Threshold	Average Delay threshold (s)	Queue threshold (PCU)
		0.85	36.00	20.00

Demand Set Summary

ID	Scenario name	Time Period name	Traffic profile type	Start time (HH:mm)	Finish time (HH:mm)	Time segment length (min)	Single time segment only
D13	DO SOMETHING 2039	AM	FLAT	08:00	09:00	60	✓
D14	DO SOMETHING 2039	PM	FLAT	17:00	18:00	60	✓

Analysis Set Details

ID	Name	Network flow scaling factor (%)
A1	JUNCTION 5 - Assessment Layout Option 2	100.000

JUNCTION 5 - Assessment Layout Option 2 - DO SOMETHING 2039, AM

Data Errors and Warnings

No errors or warnings

Junction Network

Junctions

Junction	Name	Junction type	Use circulating lanes	Arm order	Junction Delay (s)	Junction LOS
1	untitled	Standard Roundabout		1, 2, 3, 4	3.15	A

Junction Network Options

Driving side	Lighting
Left	Normal/unknown

Arms

Arms

Arm	Name	Description
1	Phase 1 and 2 Site Access Road (E)	
2	R125 (S)	
3	Minor Western Arm	
4	R125 (N)	

Roundabout Geometry

Arm	V - Approach road half-width (m)	E - Entry width (m)	I' - Effective flare length (m)	R - Entry radius (m)	D - Inscribed circle diameter (m)	PHI - Conflict (entry) angle (deg)	Exit only
1	3.50	6.00	20.0	36.5	50.0	27.7	
2	3.80	7.00	25.0	25.0	50.0	26.2	
3	3.50	6.00	20.0	36.5	50.0	27.7	
4	3.70	7.20	25.0	25.3	50.0	32.1	

Slope / Intercept / Capacity

Roundabout Slope and Intercept used in model

Arm	Final slope	Final intercept (PCU/hr)
1	0.608	1650
2	0.649	1881
3	0.608	1650
4	0.639	1859

The slope and intercept shown above include any corrections and adjustments.

Traffic Demand

Demand Set Details

ID	Scenario name	Time Period name	Traffic profile type	Start time (HH:mm)	Finish time (HH:mm)	Time segment length (min)	Single time segment only
D13	DO SOMETHING 2039	AM	FLAT	08:00	09:00	60	✓

Vehicle mix source	PCU Factor for a HV (PCU)
HV Percentages	2.00

Demand overview (Traffic)

Arm	Linked arm	Use O-D data	Average Demand (Veh/hr)	Scaling Factor (%)
1		✓	136	100.000
2		✓	652	100.000
3		✓	0	100.000
4		✓	557	100.000

Origin-Destination Data

Demand (Veh/hr)

		To			
		1	2	3	4
From	1	0	113	0	23
	2	149	0	0	503
	3	0	0	0	0
	4	34	523	0	0

Vehicle Mix

Heavy Vehicle Percentages

		To			
		1	2	3	4
From	1	0	0	0	0
	2	0	0	0	5
	3	0	0	0	0
	4	0	5	0	0

Results

Results Summary for whole modelled period

Arm	Max RFC	Max Delay (s)	Max Queue (Veh)	Max LOS
1	0.10	3.05	0.1	A
2	0.36	3.14	0.6	A
3	0.00	0.00	0.0	A
4	0.33	3.19	0.5	A

Main Results for each time segment

08:00 - 09:00

Arm	Total Demand (Veh/hr)	Circulating flow (Veh/hr)	Capacity (Veh/hr)	RFC	Throughput (Veh/hr)	End queue (Veh)	Delay (s)	Unsignalised level of service
1	136	523	1316	0.103	136	0.1	3.049	A
2	652	23	1797	0.363	651	0.6	3.140	A
3	0	674	1225	0.000	0	0.0	0.000	A
4	557	149	1685	0.331	557	0.5	3.189	A

JUNCTION 5 - Assessment Layout Option 2 - DO SOMETHING 2039, PM

Data Errors and Warnings

No errors or warnings

Junction Network

Junctions

Junction	Name	Junction type	Use circulating lanes	Arm order	Junction Delay (s)	Junction LOS
1	untitled	Standard Roundabout		1, 2, 3, 4	3.04	A

Junction Network Options

Driving side	Lighting
Left	Normal/unknown

Traffic Demand

Demand Set Details

ID	Scenario name	Time Period name	Traffic profile type	Start time (HH:mm)	Finish time (HH:mm)	Time segment length (min)	Single time segment only
D14	DO SOMETHING 2039	PM	FLAT	17:00	18:00	60	✓

Vehicle mix source	PCU Factor for a HV (PCU)
HV Percentages	2.00

Demand overview (Traffic)

Arm	Linked arm	Use O-D data	Average Demand (Veh/hr)	Scaling Factor (%)
1		✓	196	100.000
2		✓	651	100.000
3		✓	0	100.000
4		✓	442	100.000

Origin-Destination Data

Demand (Veh/hr)

		To			
		1	2	3	4
From	1	0	159	0	37
	2	134	0	0	517
	3	0	0	0	0
	4	30	412	0	0

Vehicle Mix

Heavy Vehicle Percentages

		To			
		1	2	3	4
From	1	0	0	0	0
	2	0	0	0	5
	3	0	0	0	0
	4	0	5	0	0

Results

Results Summary for whole modelled period

Arm	Max RFC	Max Delay (s)	Max Queue (Veh)	Max LOS
1	0.14	3.02	0.2	A
2	0.36	3.17	0.6	A
3	0.00	0.00	0.0	A
4	0.26	2.87	0.4	A

Main Results for each time segment

17:00 - 18:00

Arm	Total Demand (Veh/hr)	Circulating flow (Veh/hr)	Capacity (Veh/hr)	RFC	Throughput (Veh/hr)	End queue (Veh)	Delay (s)	Unsignalised level of service
1	196	412	1387	0.141	196	0.2	3.022	A
2	651	37	1786	0.364	650	0.6	3.167	A
3	0	687	1216	0.000	0	0.0	0.000	A
4	442	134	1694	0.261	442	0.4	2.874	A

Junctions 9
ARCADY 9 - Roundabout Module
Version: 9.5.1.7462 © Copyright TRL Limited, 2019
For sales and distribution information, program advice and maintenance, contact TRL: +44 (0)1344 379777 software@trl.co.uk www.trlsoftware.co.uk
The users of this computer program for the solution of an engineering problem are in no way relieved of their responsibility for the correctness of the solution

Filename: Junction 7 AM-PM.j9
Path: M:\Projects\12\12-081A - Dunshaughlin Phase 2 - Civils\Design\Traffic\Modelling SEPTEMBER 2020\Option 2 - South Site - Two Separate Areas\Junction 7
Report generation date: 18/09/2020 14:32:50

- »JUNCTION 7 - Assessment Layout Option 2 - DO SOMETHING 2039, AM
- »JUNCTION 7 - Assessment Layout Option 2 - DO SOMETHING 2039, PM

Summary of junction performance

AM						PM				
	Set ID	Queue (Veh)	Delay (s)	RFC	LOS	Set ID	Queue (Veh)	Delay (s)	RFC	LOS
JUNCTION 7 - Assessment Layout Option 2 - DO SOMETHING 2039										
Arm 1	D5	0.1	2.98	0.06	A	D6	0.0	2.76	0.02	A
Arm 2		0.7	3.91	0.41	A		0.8	3.99	0.43	A
Arm 3		0.8	4.34	0.43	A		0.6	4.05	0.39	A

Values shown are the highest values encountered over all time segments. Delay is the maximum value of average delay per arriving vehicle.

File summary

File Description

Title	
Location	
Site number	
Date	22/07/2020
Version	
Status	(new file)
Identifier	
Client	
Jobnumber	
Enumerator	DOMAINf.silva
Description	

Units

Distance units	Speed units	Traffic units input	Traffic units results	Flow units	Average delay units	Total delay units	Rate of delay units
m	kph	Veh	Veh	perHour	s	-Min	perMin

Analysis Options

Calculate Queue Percentiles	Calculate residual capacity	RFC Threshold	Average Delay threshold (s)	Queue threshold (PCU)
		0.85	36.00	20.00

Demand Set Summary

ID	Scenario name	Time Period name	Traffic profile type	Start time (HH:mm)	Finish time (HH:mm)	Time segment length (min)	Single time segment only
D5	DO SOMETHING 2039	AM	FLAT	08:00	09:00	60	✓
D6	DO SOMETHING 2039	PM	FLAT	17:00	18:00	60	✓

Analysis Set Details

ID	Name	Network flow scaling factor (%)
A1	JUNCTION 7 - Assessment Layout Option 2	100.000

JUNCTION 7 - Assessment Layout Option 2 - DO SOMETHING 2039, AM

Data Errors and Warnings

No errors or warnings

Junction Network

Junctions

Junction	Name	Junction type	Use circulating lanes	Arm order	Junction Delay (s)	Junction LOS
1	untitled	Standard Roundabout		1, 2, 3	4.05	A

Junction Network Options

Driving side	Lighting
Left	Normal/unknown

Arms

Arms

Arm	Name	Description
1	Phase 2 Site Access Road (E)	
2	R125 (W)	
3	R125 (N)	

Roundabout Geometry

Arm	V - Approach road half-width (m)	E - Entry width (m)	I' - Effective flare length (m)	R - Entry radius (m)	D - Inscribed circle diameter (m)	PHI - Conflict (entry) angle (deg)	Exit only
1	3.80	6.40	15.0	20.0	58.0	30.0	
2	3.80	6.40	15.0	20.0	58.0	30.0	
3	3.80	6.20	10.0	17.0	58.0	30.0	

Slope / Intercept / Capacity

Roundabout Slope and Intercept used in model

Arm	Final slope	Final intercept (PCU/hr)
1	0.561	1658
2	0.561	1658
3	0.539	1549

The slope and intercept shown above include any corrections and adjustments.

Traffic Demand

Demand Set Details

ID	Scenario name	Time Period name	Traffic profile type	Start time (HH:mm)	Finish time (HH:mm)	Time segment length (min)	Single time segment only
D5	DO SOMETHING 2039	AM	FLAT	08:00	09:00	60	✓

Vehicle mix source	PCU Factor for a HV (PCU)
HV Percentages	2.00

Demand overview (Traffic)

Arm	Linked arm	Use O-D data	Average Demand (Veh/hr)	Scaling Factor (%)
1		✓	83	100.000
2		✓	646	100.000
3		✓	636	100.000

Origin-Destination Data

Demand (Veh/hr)

		To		
		1	2	3
From	1	0	54	29
	2	23	0	623
	3	12	624	0

Vehicle Mix

Heavy Vehicle Percentages

		To		
		1	2	3
From	1	0	0	0
	2	0	0	5
	3	0	5	0

Results

Results Summary for whole modelled period

Arm	Max RFC	Max Delay (s)	Max Queue (Veh)	Max LOS
1	0.06	2.98	0.1	A
2	0.41	3.91	0.7	A
3	0.43	4.34	0.8	A

Main Results for each time segment

08:00 - 09:00

Arm	Total Demand (Veh/hr)	Circulating flow (Veh/hr)	Capacity (Veh/hr)	RFC	Throughput (Veh/hr)	End queue (Veh)	Delay (s)	Unsignalised level of service
1	83	623	1291	0.064	83	0.1	2.979	A
2	646	29	1566	0.412	645	0.7	3.906	A
3	636	23	1465	0.434	635	0.8	4.335	A

JUNCTION 7 - Assessment Layout Option 2 - DO SOMETHING 2039, PM

Data Errors and Warnings

No errors or warnings

Junction Network

Junctions

Junction	Name	Junction type	Use circulating lanes	Arm order	Junction Delay (s)	Junction LOS
1	untitled	Standard Roundabout		1, 2, 3	3.99	A

Junction Network Options

Driving side	Lighting
Left	Normal/unknown

Traffic Demand

Demand Set Details

ID	Scenario name	Time Period name	Traffic profile type	Start time (HH:mm)	Finish time (HH:mm)	Time segment length (min)	Single time segment only
D6	DO SOMETHING 2039	PM	FLAT	17:00	18:00	60	✓

Vehicle mix source	PCU Factor for a HV (PCU)
HV Percentages	2.00

Demand overview (Traffic)

Arm	Linked arm	Use O-D data	Average Demand (Veh/hr)	Scaling Factor (%)
1		✓	31	100.000
2		✓	677	100.000
3		✓	571	100.000

Origin-Destination Data

Demand (Veh/hr)

		To		
		1	2	3
From	1	0	20	11
	2	36	0	641
	3	19	552	0

Vehicle Mix

Heavy Vehicle Percentages

		To		
		1	2	3
From	1	0	0	0
	2	0	0	5
	3	0	5	0

Results

Results Summary for whole modelled period

Arm	Max RFC	Max Delay (s)	Max Queue (Veh)	Max LOS
1	0.02	2.76	0.0	A
2	0.43	3.99	0.8	A
3	0.39	4.05	0.6	A

Main Results for each time segment

17:00 - 18:00

Arm	Total Demand (Veh/hr)	Circulating flow (Veh/hr)	Capacity (Veh/hr)	RFC	Throughput (Veh/hr)	End queue (Veh)	Delay (s)	Unsignalised level of service
1	31	551	1333	0.023	31	0.0	2.763	A
2	677	11	1577	0.429	676	0.8	3.992	A
3	571	36	1459	0.391	570	0.6	4.047	A

UK and Ireland Office Locations

